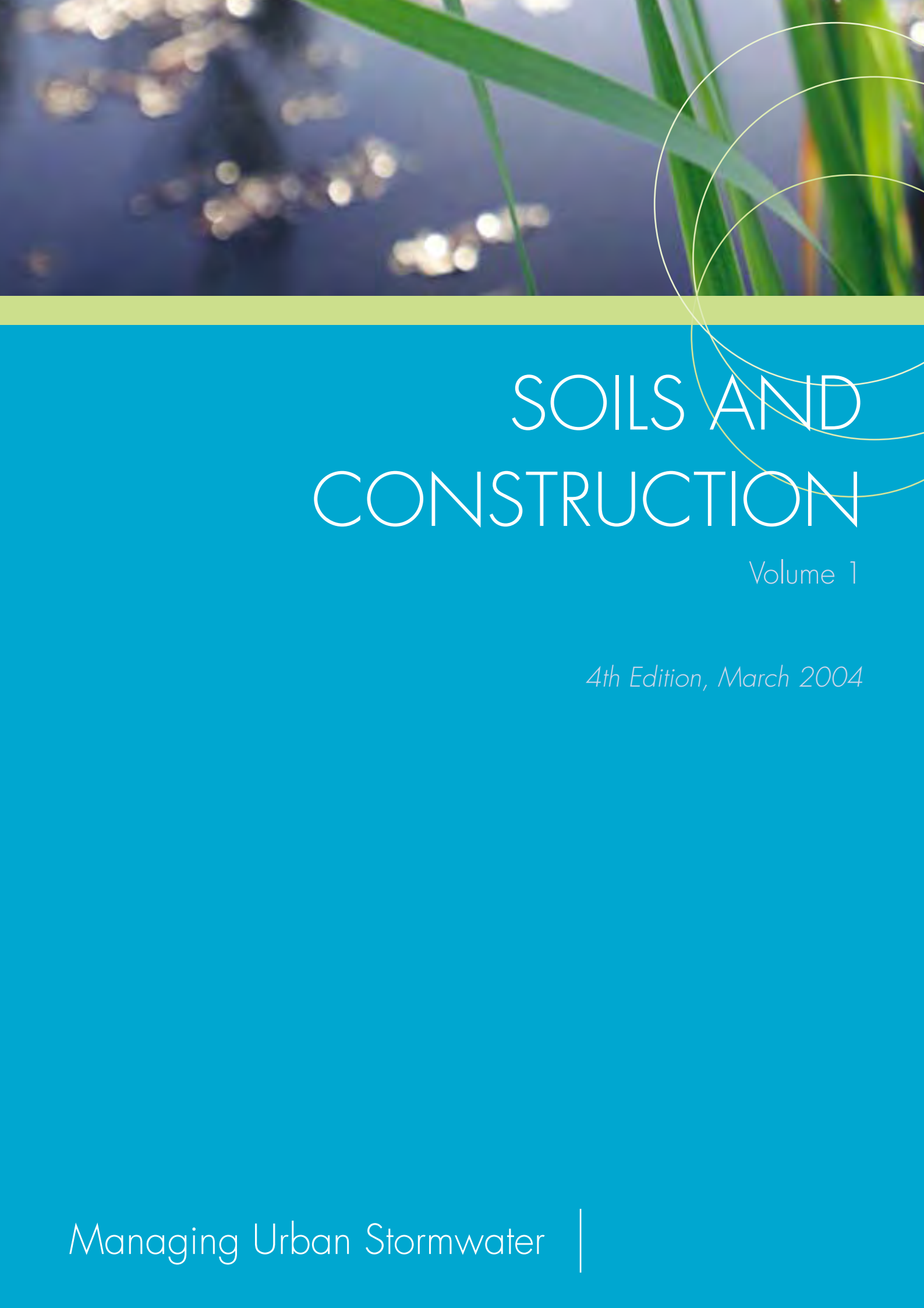


NAVIGATING THIS PDF DOCUMENT

In this pdf, you are able to turn pages as in a traditional book, change the magnification of the page you are viewing, and return easily to previous page views.

BOOKMARKS – Bookmarks are located in the navigation panel on your left hand-side. They are special links that can serve as a table of contents. Simply click on the designated section and it will link you directly to this location.

CONTENTS – If you would like to go to a specific page in each chapter, click Contents in the Bookmark panel. The contents page consists of sections within each chapter and the corresponding page number is located on the right hand-side. Click on the page number to go to the corresponding page within the document.



SOILS AND CONSTRUCTION

Volume 1

4th Edition, March 2004

Managing Urban Stormwater |

Attitudes to stormwater pollution and the environment have changed significantly. Today, both the community and the Government expect a greater commitment to environmental protection.

Sustainable development is an essential tool for protection of our waterways. Housing and infrastructure need to be provided for a growing population while protecting our fragile environment through the conservation and enhancement of natural resources.

To help achieve healthier waterways, the NSW Government is releasing a series of publications aimed at improving urban stormwater management practices. This document forms part of the *Managing Urban Stormwater* series.

Comprehensive guidelines in this publication will help all those involved in the construction industry to comply with appropriate stormwater quality outcomes. These outcomes have been established by various consent authorities, including the Department of Environment and Conservation (DEC) and local government. The document contains special design suggestions, on how to obtain approvals from regulatory bodies.

This publication which has been managed and funded by Landcom updates an earlier edition published by the Department of Housing in 1998. Valuable input was provided by other NSW Government agencies, local government, industry groups and consultants.

I congratulate everyone involved in the production of this publication. It is an excellent example of how the public and private sectors and industry associations can work together to protect the environment for future generations.

The document contains the tools needed to help mitigate land and water degradation. It should be required reading for those involved in the construction industry.



The Hon Carl Scully MP
Minister for Housing
Minister for Roads
Leader of the House



For further copies of this handbook contact:

Landcom
PO Box 237
PARRAMATTA NSW 2150

Phone: (02) 9841 8600
Fax: (02) 9841 8777
e-mail: bluebook@landcom.nsw.gov.au
web: www.landcom.nsw.gov.au

CONTENTS

1. Introduction	1-1
1.1 Background	1-1
1.2 Purpose of these guidelines	1-1
1.3 Format of this document	1-4
1.4 The Problem	1-5
1.4.1 Causes of Urban Land Degradation	1-5
1.4.2 Cost of Degradation	1-5
1.5 Ecologically Sustainable Development (ESD)	1-7
1.6 General Principles of Soil and Water Management	1-9
1.6.1 Background	1-9
1.6.2 The Work's Program	1-11
1.7 Legislation and Policy Requirements	1-12
2. Plan Preparation	2-1
2.1 Background	2-1
2.2 Erosion and Sediment Control Plans (ESPs)	2-2
2.3 Soil and Water Management Plans (SWMPs)	2-3
2.3.1 Important considerations	2-3
2.3.2 Data Input	2-5
3. Assessment of Constraint and Opportunities	3-1
3.1 Introduction	3-1
3.2 Site Constraints	3-2
3.2.1 Waterfront (riparian) Lands	3-2
3.2.2 Flooding	3-2
3.2.3 Rainfall Erosivity	3-3
3.2.4 Soil Erodibility	3-3
3.2.5 Soil Erosion Hazard	3-3
3.2.6 Dispersibility	3-4
3.2.7 Soil Texture Group	3-5
3.2.8 Expansive or Reactive Soils	3-6
3.2.9 Runoff Coefficient	3-7
3.2.10 Unified Soil Classification	3-7
3.2.11 Soil pH	3-8
3.2.12 Waterables	3-8
3.2.13 Salinity	3-9
3.2.14 Acid Sulfate Soils	3-10
3.2.15 Soil Contamination/Toxicities/Pollution in Soils	3-11
3.2.16 Mass movement	3-11
3.3 Data Collection	3-13
3.3.1 Soil Data	3-13
3.3.2 Other Data	3-14
3.3.3 Some Data Sources	3-16
3.4 Data Application	3-16
4. Erosion Control: Management of Soils	4-1
4.1 Introduction	4-1
4.2 Planning Considerations	4-2

4.3	Handling Soils	4-3
4.3.1	General erosion control guidelines	4-3
4.3.2	Topsoil handling procedures	4-3
4.4	Special Considerations for SWMPs	4-9
4.4.1	Assessment of Erosion Hazard	4-9
4.4.2	Management of Sites of Erosion Hazard	4-9
5.	Erosion Control: Management of Water	5-1
5.1	Introduction	5-1
5.2	Classification of Waterbodies Based on Objectives for Riparian Land	5-2
5.3	Works Within the CRZ	5-5
5.3.1	Introduction	5-5
5.3.2	Protection of Riparian/forshore/intertidal Areas	5-7
5.3.3	Works in Watercourses	5-8
5.3.4	Temporary Waterway Crossings	5-13
5.3.5	Construction of Culverts and Bridges	5-15
5.4	Regular Site Drainage Works	5-15
5.4.1	General Recommendations	5-15
5.4.2	Sheet Flows	5-16
5.4.3	Concetrated Flows	5-17
5.4.4	Temporary Water Diversion Structures	5-23
5.4.5	Energy Dissipaters and Outlet Protection	5-31
5.4.6	Subsoil Drainage	5-33
6.	Sediment and Waste Control	6-1
6.1	Introduction	6-1
6.1.1	Background	6-1
6.1.2	Pollutants	6-2
6.1.3	General Recommendations	6-4
6.2	Waste Control	6-5
6.3	Sediment Control	6-7
6.3.1	Preamble	6-7
6.3.2	General Recommendations	6-8
6.3.3	Design of Sediment Basins	6-9
6.3.4	Capacity of Basins for <i>Type D</i> and <i>Type F</i> Soils	6-15
6.3.5	Capacity of Basins for <i>Type C</i> Soils	6-28
6.3.6	Infiltration sumps	6-30
6.3.7	Sediment Filters	6-33
6.3.8	Filter Strips	6-42
6.3.9	Stabilised Site Access	6-43
6.3.10	Control of Wind Erosion	6-46
6.4	Constructed Wetlands	6-47
6.4.1	Preamble	6-47
6.4.2	Introduction	6-50
6.4.3	Planning	6-50
6.4.4	Wetland Design	6-52

7. Site Stabilisation	7-1
7.1 Introduction	7-1
7.1.1 Background	7-1
7.1.2 General Principles	7-2
7.2 Revegetation: Lands Subjected to Sheet Flow	7-4
7.2.1 Introduction	7-4
7.2.2 Primary Revegetation	7-4
7.2.3 Secondary Revegetation	7-8
7.3 Revegetation: Lands Subjected to Concentrated Flow	7-9
7.3.1 Introduction	7-9
7.4 Special Considerations	7-10
7.4.1 Aids to Establishment	7-10
7.4.2 Saline Areas	7-13
7.4.3 Maintenance	7-14
8. Maintenance	8-1
8.1 Introduction	8-1
8.2 Maintenance Program	8-1
8.3 Post Construction Issues	8-8
9. Urban Construction Sites	9-1
9.1 Preamble	9-1
9.1.1 Purpose, Scope and Objectives	9-1
9.1.2 Temporary Measures	9-1
9.1.3 Permanent Measures	9-4
9.2 Residential Dwelling Requiring an ESCP	9-5
9.2.1 Introduction	9-5
9.2.2 Model ESCP for a Residential Dwelling	9-5
9.3 Medium-density Development Requiring a SWMP	9-10
9.3.1 Introduction	9-10
9.3.2 Model SWMP for a Medium-density	9-10
9.4 Subdivision Development Requiring a SWMP	9-19
9.4.1 Model SWMP for a Subdivision Development	9-19
10. Bibliography	10-1

APPENDICES

Appendix A	A-1
A1 Revised Universal Soil Loss Equation	A-1
A2 Rainfall Erosivity Factor – R	A-2
A3 Soil Erodibility Factor – K	A-6
A4 Slope Length/Gradient Factor – LS	A-9
A5 Erosion Control Practice Factor – P	A-10
A6 Cover Factor – C	A-11
A7 Sediment Yields	A-14
Appendix B – R-Factor Maps	B-1
Appendix C – Constraints to Development	C-1
Appendix D – Use of Erosion Control Products	D-1
Appendix E – Settlement of Dispersed Fines	E-1
E1 The Problem	E-1
E2 A Quick Field Test	E-1
E3 Management of Dispersible Fines	E-2
E3.1 The Process	E-2
E3.2 Common Agents	E-2
E3.3 Application Rates	E-3
E3.4 Some Warnings	E-3
E4 Two Suggested Methodologies	E-5
E4.1 Manual Dosing of Basins Using Gypsum	E-5
E4.2 Automated Dosing of Stormwater Using Polyaluminium Chloride	E-7
Appendix F – Runoff Coefficients	F-1
F1 Introduction	F-1
F2 Soil Hydrologic Group	F-1
F3 Volumetric Runoff Coefficient	F-4
F4 Peak Flow Runoff Coefficient	F-4
Appendix G – Rehabilitation Recommendations	G-1
G1 Site Assessment	G-1
G2 Species Selection	G-3
G3 Fertilisers and Ameliorants	G-4
Appendix H – Vegetation Management Plan	H-1
Appendix I – Management of Waterfront Land	I-1
I1 Introduction	I-1
I2 Principles Governing the Management of Controlled Activities	I-1
I3 Indigenous Considerations	I-2

14	New Directions	I-3
15	Controlled Activity Policies	I-5
16	Controlled Activity Approval Application Process	I-6
17	Information Required with an Application	I-7
	1.7.1 Basic information	I-7
	1.7.2 Information required for the assessment of an application will include	I-8
	1.7.3 Further detailed information required	I-9
	1.7.4 Fees for applications	I-9
18	Determination of Applications	I-9
	1.8.1 Assessment	I-9
	1.8.2 WMA can require multiple approvals	I-10
	1.8.3 Controlled Activity Approvals and the Native Vegetation Conservation Act	I-10
	1.8.4 Integrated development and other cases where authorisation under different statutes is required	I-10
	1.8.5 Security deposits	I-11
	1.8.6 Register of applications and approvals	I-11

Appendix J – Worksheets

J-1

J1	The Standard Worksheet	J-1
	1 Site Data Sheet	J-1
	2 Storm Flow Calculations	J-2
	3 Volume of Sediment Basins: <i>Type C Soils</i>	J-3
	4 Volume of Sediment Basins, <i>Type D</i> and <i>Type F Soils</i>	J-4
J2	The Detailed Sheet	J-5
	1 Site Data Sheet	J-5
	2 Storm Flow Calculations	J-7
	3 Volume of Sediment Basins: <i>Type C Soils</i>	J-8
	4 Volume of Sediment Basins, <i>Type D</i> and <i>Type F Soils</i>	J-9

Appendix K – Relevant NSW Legislation

K-1

Environmental Legislation: Urban Areas in NSW	K-1
Environmental Planning and Assessment Act, 1979 (EP&A Act)	K-2
Protection of the Environment Operations Act (POEO Act)	K-3
Rivers and Forshores Improvement Act, 1948	K-4
Soils Conversation Act, 1938	K-4
Native Vegetation Conservation Act, 1997	K-5
The Local Act, 1993	K-5
Catchment Management Act, 1989	K-6
Fisheries Management Act, 1994	K-6
The Water Administration Act, 1986	K-7
Noxious Act, 1993	K-8

Appendix L (on CD)

L-1

CD Contains:

- Graphs showing Y-percentile, X-day rainfall depths (mm) for 59 sites across New South Wales
- Graphs for interpolation of rainfall depths at locations or for time periods not listed above
- Excel spreadsheets for estimating the size of sediment retention basins (as shown at Appendix J)

Appendix M – Model Code of Practice for soil & Water Management on Urban Lands

M-1

Intent

M-1

Scope

M-1

Other Needs

M-2

General Planning Requirements

M-2

Environmental Bond

M-4

SWMP/ESP Content

M-5

Access and Roads

M-7

Clearing Vegetation

M-7

Site Works

M-10

Stormwater Control

M-12

Pollution Control

M-12

Rehabilitation and Landscaping

M-14

Attachment 1: C-factor

M-15

Attachment 2: Environmental Bond

M-16

Attachment 3: Demerit Point System

M-16

Attachment 4: Responsibilities for Council's Officers

M-18

Appendix N – Glossary

N-1

1.1	Sediment concentrations and daily rainfall at one site at Albion Park	1-7
1.2	Suggested works sequence	1-10
2.1a	Inspection and Test Plan	2-8
2.1b	Inspection and Test Plan	2-9
3.1	Landslip in the Picton area of New South Wales	3-12
4.1	Division of storm rainfall into its component parts assuming constant precipitation	4-1
4.2	Construction of a berm drain	4-3
4.3a	A track-walked slope	4-7
4.3b	A track-walked slope	4-8
4.4	Phasing of rehabilitation is clearly evident on this batter	4-8
4.5	Recently rehabilitated lands at an urban subdivision near Sydney	4-9
4.6	Assessment of potential erosion hazard	4-10
4.7	Maximum batter gradient (H:V) where the R-factor is 1,100, 1,400, 1,800 and 2,400	4-11
4.8	Maximum batter gradient (H:V) where the R-factor is 3,400, 5,200, 9,000 and 25,000	4-12
4.9	Rainfall distribution zones in New South Wales	4-16
5.1	Pool and riffle zone sequence	5-10
5.2	Use of rock to stabilise a stream bank	5-11
5.3a	Use of rock check dams to reduce the erosive energy of flow	5-20
5.3b	Alternate dam system	5-21
5.4	A rock-lined waterway	5-29
5.5	Cross-section of a typical paved chute	5-30
5.6	Cross-section of a typical pipe drain	5-30
5.7	Use of heavy-duty flexible pipe to carry water down a batter	5-31
5.8	A riprap outlet on a steep slope	5-32
5.9	Design of riprap outlet protection – maximum tailwater conditions	5-35
5.10	Design of riprap outlet protection – minimum tailwater conditions	5-35
5.11	Riprap configuration for outlet protection under both maximum and minimum tailwater conditions	5-36
6.1	Sediment deposition of housing construction site	6-3
6.2	Sediment resulting from unsatisfactory rehabilitation following roadworks	6-3
6.3	Apparent effectiveness of a sediment containment system	6-11
6.4	Diagrammatic examples of placement of baffles in sediment basins to increase the ratio of length to width	6-13
6.5	Y-percentile 2, 5, 10 and 20	6-23
6.6	The 75th, 85th and 95th percentile 5-day rainfall depth estimated from the annual mean rainfall	6-26
6.7	A sediment retention basin constructed on Type C soils with gabion baskets in very steep country	6-31
6.8	A sediment retention basin constructed on Type C soils from local sandstone gibbers	6-31
6.9	Sediment fence constructed below a fill batter – the sediment pollution is the result of a recent storm event	6-34
6.10	Preferred sediment fence configuration	6-34
6.11	Filter roll at kerb-side sump	6-37
6.12	A kerbside turf strip showing sediment stored in the area above the filter	6-45
6.13	A simple wash-down system	6-45
6.14	Effect of distance from windbreak on soil loss	6-46
7.1	Unsatisfactory site stabilisation has resulted in substantial quantities of sediment leaving the site	7-5
7.2	Primary revegetation of an earth batter with straw mulching	7-5
7.3	Seed placement with different sowing methods	7-8

7.4	Lack of site stabilisation of a drainage line following installation of services	7-12
7.5	Effective mulching of a service easement using local brush	7-12
9.1	Typical medium-density, inner-city construction site	9-3
9.2	Two options for an ESCP where the site flows from the front and to the rear of the site	9-6
9.3	Two options for an ESCP where the site flows to either side of the site	9-7
9.4	Erosion and sediment control plan for a residential dwelling	9-9
A1	R-factors for Australia	A-3
A2	Average annual soil losses calculated for a site near Richmond, NSW, based on the usual R-factor, and the 50 percent, 20 percent and 5 percent AEP	A-5
A3	Soil erodity nomograph in SI units	A-7
A4	Smooth and compact ground surface typical of an urban construction site, raising the P-factor as high as 1.3	A-10
A5	C-factors for established grass cover	A-12
A6	Calculated annual soil losses for different land uses	A-12
B	Rainfall Erosivity values	B-2
	Rainfall Erosivity of the Warwick 1:250,000 Topographic Sheet	B-3
	Rainfall Erosivity of the Tweed Heads 1:250,000 Topographic Sheet	B-4
	Rainfall Erosivity of the Grafton 1:250,000 Topographic Sheet	B-5
	Rainfall Erosivity of the Maclean 1:250,000 Topographic Sheet	B-6
	Rainfall Erosivity of the Dorigo 1:250,000 Topographic Sheet	B-7
	Rainfall Erosivity of the Tamworth 1:250,000 Topographic Sheet	B-8
	Rainfall Erosivity of the Hastings 1:250,000 Topographic Sheet	B-9
	Rainfall Erosivity of the Singleton 1:250,000 Topographic Sheet	B-10
	Rainfall Erosivity of the Newcastle 1:250,000 Topographic Sheet	B-11
	Rainfall Erosivity of the Sydney 1:250,000 Topographic Sheet	B-12
	Rainfall Erosivity of the Wollongong 1:250,000 Topographic Sheet	B-13
	Rainfall Erosivity of the Canberra 1:250,000 Topographic Sheet	B-14
	Rainfall Erosivity of the Ulladulla 1:250,000 Topographic Sheet	B-15
	Rainfall Erosivity of the Bega 1:250,000 Topographic Sheet	B-16
	Rainfall Erosivity of the Mallacoota 1:250,000 Topographic Sheet	B-17
C	Soil Landscape Maps	C-5
E1	Application of gypsum	E-6
E2	Poor gypsum application technique	E-6
E3	Sediment settlement system components	E-8
E4	Sediment settlement system dosing details	E-8
E5	Construction of the catchment tray	E-10
F1	Minimum profile depth where confining layers can affect Soil Hydrologic Group	F-3
M1	C-factors for established grass cover	M-15

TABLES

1.1	Estimates of sediment loadings entering Lake Macquarie	1-6
1.2	Key Policy Objectives of the NSW Government and its Agencies	1-14
1.3	Principal Roles and Responsibilities of the Various NSW Government Agencies	1-16
2.1	Suggested Plan Type	2-1
3.1	Landform Elements	3-15
4.1	Works limitations	4-2
4.2	The Soil Loss Classes	4-13
4.3	Lands where special erosion control measures apply	4-15
5.1	Summary of Riparian Management Objectives	5-4
5.2	Maximum Design Flow Velocities in Waterways	5-24
6.1	Summary of selected sediment basin types and design criteria	6-12
6.2	Percentage of average annual EI that normally occurs in the first and second half of each month for each Rainfall Zone	6-23
6.3a	75th, 80th, 85th, 90th and 95th-percentile 2 and 5-day rainfall depths for 59 sites in New South Wales	6-24
6.3b	75th, 80th, 85th, 90th and 95th-percentile 10 and 20-day rainfall depths for 59 sites in New South Wales	6-25
6.4	Recommended Grass Filter Strip Widths for Typical Values of Calculated Annual Soil Loss	6-43
7.1	Maximum acceptable C-factors at nominated times during works	7-3
8.1	Example of a Self-audit Check Sheet	8-5
8.2	Guidelines that might apply to inspection of structural measures	8-6
8.3	Guidelines that might apply to inspection of non-structural measures	8-7
8.4	Guidelines that might apply to the control of wind-borne particles	8-8
9.1	Constraints and characteristics	9-11
9.2	Limitations to access	9-13
9.3	Maximum C-factors at Nominated Times During Works	9-15
9.4	Plant Species for Ground Cover	9-15
9.5	Constraints and characteristics	9-20
9.6	Limitations to access	9-21
9.7	Maximum acceptable C-factors at Nominated Times During Works	9-30
9.8	Plant species for temporary cover	9-30
A1	LS-factors on construction sites using the RUSLE	A-9
A2	P-factors for construction sites	A-11
A3	Soil Stabilisation Control Matrix	A-12
A4	Factors for practices tested in University of Washington research	A-13
C1	Murwillumbah Soil Landscapes	C-6
C2	Lismore-Ballina Soil Landscapes	C-9
C3	Woodburn Soil Landscapes	C-13
C4	Dorrigo Soil Landscapes	C-23
C5	Coffs Harbour Soil Landscapes	C-27
C6	Macksville Soil Landscapes	C-30
C7	Curlewis Soil Landscapes	C-35
C8	Tamworth Soil Landscapes	C-41
C9	Kempsey-Korogoro Point Soil Landscapes	C-51
C10	Blackville Soil Landscapes	C-57
C11	Murrurundi Soil Landscapes	C-62
C12	Dungog Soil Landscapes	C-71
C13	Newcastle Soil Landscapes	C-76
C14	Port Stephens Soil Landscapes	C-85
C15	Wallerawang Soil Landscapes	C-89


C16	St Albans Soil Landscapes	C-93
C17	Gosford-Lake Macquarie Soil Landscapes	C-95
C18	Katoomba Soil Landscapes	C-98
C19	Penrith Soil Landscapes	C-102
C20	Sydney Soil Landscapes	C-104
C21	Wollongong-Port Hacking Soil Landscapes	C-107
C22	Kiama Soil Landscapes	C-109
C23	Wagga Wagga Soil Landscapes	C-112
C24	Canberra Soil Landscapes	C-116
C25	Braidwood Soil Landscapes	C-122
C26	Michelago Soil Landscapes	C-127
C27	Cooma Soil Landscapes	C-133
C28	Bega-Goalen Soil Landscapes	C-142
C29	Narooma Soil Landscapes	C-145
D1	Erosion Control products for stabilising disturbed lands	D-8
E1	Rainfall Catchment Tray Areas for Different Aluminium Dose Rates for a 50-mm Rainfall Depth	E-10
F1	Effect of K _{sat} and profile infiltration rates on Soil Hydrologic Group	F-3
F2	Runoff coefficients (CV) for volumetric data in disturbed catchments	F-4
F3	Runoff coefficients (C10) for peak flow in disturbed catchments	F-6
G1	Starter fertiliser options for grasses	G-7
G2	Follow-up fertiliser options for grasses	G-7
G3	Fertiliser requirements for individual plants, on a plant-by-plant basis	G-8
G4	Fertiliser requirements for individual plants, general surface dressing	G-8
M1	Scope of requirements for the Code of Practice	M-1
M2		M-20

STANDARD DRAWINGS

4.1	Stockpiles	4-5
4.2	Replacing Topsoil	4-6
5.1	Temporary Waterway Crossing	5-14
5.2	RECP: Sheet Flow	5-18
5.3	Cellular Confinement Systems	5-19
5.4	Rock Check Dam	5-22
5.5	Earth Bank (Low Flow)	5-25
5.6	Earth Bank (High Flow)	5-26
5.7	RECP: Concentrated Flow	5-28
5.8	Energy Dissipater	5-34
6.1	Rock Sediment Basin	6-16
6.2	Gabion Sediment Basin	6-17
6.3	Earth Basin – Dry	6-18
6.4	Earth Basin – Wet	6-19
6.5	Lined Tank	6-20
6.6	Infiltration Sump	6-32
6.7	Straw Bale Filter	6-35
6.8	Sediment Fence	6-36
6.9	Alternate Sediment Fence	6-38
6.10	Turbidity Barrier	6-39
6.11	Mesh and Gravel Inlet Filter	6-40
6.12	Geotextile Inlet Filter	6-41
6.13	Kerbside Turf Strip	6-44
6.14	Stabilised Site Access	6-48
7.1	Seedbed Preparation	7-7

ACKNOWLEDGEMENTS

1. The following publications/papers provided valuable resource data to the development of this handbook additional to those listed in the third edition of this handbook (Department of Housing, 1998):
 - Beca Carter Hollings & Ferner Ltd (2003). *Report TP90 Flocculation Guidelines*. Auckland Regional Council, Auckland.
 - Fifield, G.S. (2001). *Designing for Effective Sediment and Erosion Control on Construction Sites*. Forester Press, Santa Barbara, California, USA.
 - Morse, R. (2001). "Application of Soils Data to Urban Erosion and Sediment Control Programs". In Cattle, S.R and George, B.H. (Eds.), *Describing, Analysing and Managing Our Soil*. Proceedings of the DAMOS 1999 workshop held at The University of Sydney, 22-26 November 1999. Published jointly by The University of Sydney and the Australian Society of Soil Science Inc. (NSW Branch)
 - Rosewell, C.J. and Turner, J.B. (1992). *Rainfall Erosivity in New South Wales. CaLM Technical Report No. 20*. Department of Infrastructure Planning and Natural Resources, Sydney
 - The information contained in Tables A3 and D1 was developed from a large number of sources, including various advertising material published by the product manufacturers. It has been sent to the manufacturers for the products listed or their Australian agents for review and comment. Most of these did not respond; however, some gave valuable constructive comments.
2. The preparation of this handbook was funded by:
 - Landcom
3. The principal compilers/authors of this handbook were:
 - Rick Morse, Morse McVey & Associates Pty Ltd
 - Bob Junor, Chello Hill Pty Ltd
 - Geoff McVey, Morse McVey & Associates Pty Ltd.
4. Apart from the principal compilers/authors, significant contributions were made by:
 - Shane Barter, Department of Environment and Conservation
 - Neville Pavan, Department of Infrastructure, Planning and Natural Resources
 - Marwan El-Chamy, Department of Infrastructure, Planning and Natural Resources
 - Jen Guice, Department of Infrastructure, Planning and Natural Resources.
5. People from the following organizations were on a Steering Committee overseeing the development of this handbook:
 - Department of Infrastructure, Planning and Natural Resources
 - Department of Environment and Conservation
 - Landcom
 - WSROC

-
- 
- Sydney Coastal Council
 - Baulkham Hills Shire Council
 - Blacktown City Council
 - Camden Council
 - Fairfield City Council
 - Hawkesbury City Council
 - Hornsby Shire Council
 - Kogarah Municipal Council
 - Liverpool City Council
 - Manly Council
 - Marrickville Council
 - Parramatta City Council
 - Penrith City Council
 - Warringah Council
 - Housing Industry Association
 - International Erosion Control Association
 - Stormwater Industry Association
 - Urban Development Industry Association
 - Rose Consulting Pty Ltd
 - Trees Australia Pty Ltd



Chapter 1

INTRODUCTION

1.1 Background

- (a) Changes in land uses from rural, open space or bushland settings to other forms have the potential to:
- cause dramatic disturbances to the soil
 - destroy vegetation
 - alter natural drainage pathways
 - affect the environmental and amenity values adversely, not only at the site, but areas downstream of it.

During the land disturbance phase of development, hundreds of tonnes of soil can be eroded from each hectare of land disturbed in a development process and be deposited onto nearby lands or into downstream waterways and estuaries. Of particular concern is the fine, dispersible sediment that can carry other pollutants “piggyback” and do not settle until they reach saline waters. Inadequate planning and design for land disturbance activities can impart major ongoing management costs to future communities for the removal of this sediment, to reduce stormwater pollution to acceptable levels, to reinstate the ecological values of streams and estuaries, and to enhance the values of recreational areas.

- (b) Improved environmental management is needed from all sectors of the development industry to control soil erosion and consequent sediment pollution to lands and waterways downslope.
- (c) The development and construction industries have the major responsibility for the control of erosion of soils and pollution from sediment, construction waste and the like during land disturbance activities and immediately afterwards. Land developers must fulfil their various responsibilities under the planning and legislative frameworks that have been established to ensure that works are undertaken in an environmentally sensitive manner. All operators should have a practical understanding of the principles of good soil and water management before being allowed on site.
- (d) Local councils should ensure that those who disturb lands fulfil their roles relating to stormwater management and the control of stormwater pollution. To this end, they have developed and are implementing Stormwater Management Plans that describe the specific requirements and outcomes to be achieved with development activities. Outcomes and objectives are defined in these plans for specific types and stages of urban development (i.e. construction and post construction).

1.2 Purpose of these Guidelines

- (a) If implemented, these guidelines will help mitigate the impacts of land disturbance activities on soils, landforms and receiving waters by focussing on erosion and sediment control. They will help:

-
- reduce pollution to downstream areas and receiving waters
 - reduce land degradation
 - raise an awareness of ecologically sustainable development (ESD) principles and their application to development.
- (b) The guidelines are an important element of the New South Wales (NSW) Government's urban stormwater program, which aims to improve the health, ecology and amenity of urban streams, rivers, estuaries and beaches through better management of stormwater. They:
- (i) are intended for use by all those involved in non rural land disturbance activities where more than 250 square metres of land will be affected, including developers, consultants and council officers;
 - (ii) are based on the premise that land degradation associated with land disturbance activities can be avoided or minimised, largely through appropriate planning before commencement of earthworks and by applying the best management practices (BMPs) available. Each BMP can be regarded as a "carriage" in a "treatment train" that should be implemented completely to ensure that the desired degree of soil and water management is achieved;
 - (iii) propose cost-effective BMPs based on the best available technology appropriate to particular land disturbance activities;
 - (iv) allow the user flexibility to make choices reflecting the BMP most appropriate to the individual site. These minimum goals should:
 - control erosion of soil materials
 - control sediment and other particulate matter as near to the source as practicable
 - achieve stability of soil and water management structures in the design storm event
 - achieve outcome-based performance levels relating to the control of sediment pollution and turbidity in a specified storm event; and
 - (v) do not preclude the use of sound judgment, especially in unusual situations.
- Generally, the guidelines do not describe most of the background to their technical content. This can be found in other literature.
- (c) The Department of Environment and Conservation (DEC), incorporating the former Environment Protection Authority (EPA), has been given primary responsibility for the implementation of the NSW Government's Urban Stormwater Program. To help councils and industry to improve stormwater management, the Managing Urban Stormwater (MUS) series of guidance documents, including the first edition of MUS: Soils and Construction, was published in 1997-98.

The MUS series of documents are currently being updated and revised, with the following series of documents to be published in 2004:

- (i) ***Managing Urban Stormwater: Council Handbook*** – the revised document will provide an updated framework and process that local councils can use to improve their stormwater planning and decision-making systems. The framework will allow managers to compare the effectiveness and efficiency of different stormwater management strategies, outlined in other MUS documents.
- (ii) ***Managing Urban Stormwater: Treatment Techniques*** – the revised edition will provide more detailed guidance in the selection, assessment, design and construction of a range of non-proprietary stormwater treatment measures, such as gross pollution traps, bioretention and infiltration systems, vegetated swales and constructed wetlands.
- (iii) ***Managing Urban Stormwater: Urban Design*** – this new document will provide guidance to councils and the development industry in the implementation of water sensitive urban design (WSUD) including how to support and implement WSUD through the environmental planning framework, conceptual design of a range of urban development types, at both the subdivision and allotment scale, and brief guidance in relation to water reuse and stream remediation. More detailed guidance on these latter aspects of WSUD will be provided in separate, supplementary documents.
- (iv) ***Managing Urban Stormwater: Soils and Construction***
 - *Volume 1* – this document that focuses on stormwater management, primarily erosion and sediment control during the construction-phase of urban development.
 - *Volume 2* – a supplementary document to Volume 1, which will provide guidance to industry, consent authorities and regulators in relation to erosion and sediment control for other (non-urban) development activities. This document will guide users in the application of processes and techniques detailed in Volume 1, to other development activities for which erosion and sediment control is a significant issue, such as mines and quarries, road and highway construction, waste landfill sites, construction and maintenance of unsealed roads and the installation of services.
- (v) ***Managing Urban Stormwater: Pollution Prevention*** – several guidance documents or products will be prepared to help stormwater managers employ pollution prevention strategies, such as education and auditing. These will include:
 - Council Operations Toolkit – to help local councils operations staff, supervisors and managers improve the environmental performance of their own council operations from a stormwater perspective;
 - Community education planning tool and resources – to help those with community education project management responsibilities;
 - Council Industry Assessment Kit – a business assessment mentoring system and case studies of industry assessment and education, to build the capacity of

local government officers to undertake environmental assessment and auditing; and

- Guidance for local councils to identify and address impediments to the implementation of adequate erosion and sediment controls for developments undertaken or approved by local councils.

1.3 Format of this Document

Chapter 1, this introductory chapter, includes:

- (i) a description of the general principles of soil and water management and an outline of the principles of ecologically sustainable development (ESD);
- (ii) a brief outline on how to plan for soil and water management;
- (iii) a statement on the causes of land degradation and its costs; and
- (iv) a summary of the current legislation and policy requirements of the NSW Government and its agencies that control and guide urban land developments.

Chapter 2 outlines the preparation of plans for control of soil erosion, pollution of waterways and links site attributes to the required BMPs.

Chapter 3 contains guidelines on identifying and addressing constraints and opportunities to soil and water management.

Chapter 4 describes soil and water management aspects of clearing of lands, stripping and stockpiling of soil materials, and management and reuse of topsoil for use in site rehabilitation.

Chapter 5 provides practical erosion control information covering both sheet and concentrated water flow conditions and subsoil drainage.

Chapter 6 contains applied information relating to the control of waste and sediment pollution from both water and wind.

Chapter 7 discusses soil conservation aspects of vegetative stabilisation of recently disturbed lands.

Chapter 8 outlines maintenance measures to be employed on all land disturbance sites.

Chapter 9 addresses the application of the information contained in Chapters 4 to 8 in urban development areas.

Chapter 10 is a bibliography for Volume 1.

Appendixes are included with Volume 1 that contain significant additional background data to the design of soil and water management works.

1.4 The Problem

1.4.1 Causes of Urban Land Degradation

- (a) Most land degradation associated with land disturbance activities in the Central and Eastern Divisions of NSW results from erosion by water, salinity and acid sulfate soils. Wind is the main agent of degradation in the Western Division and on sandy soils on the coast. Degradation can result in sediment pollution to lands and waterways elsewhere. In particular, rates of erosion are likely to be high wherever the vegetative cover has been disturbed and/or water artificially concentrated. For example, the erosion hazards can increase by more than one hundred fold simply by removing the protective vegetative cover. Other pollutants are often associated with the sediment, including nutrients, pesticides and other contaminants.
- (b) Rates of erosion are likely to be particularly high wherever the vegetative cover has been disturbed and/or water artificially concentrated. The problem has increased markedly in the last 10 years as more “marginal” lands have been developed for urban purposes.
- (c) Salinity is emerging as a significant problem in some urban areas causing damage to building foundations, service facilities and road pavements. Salinity results from the accumulation of soluble salts on the soil surface. Commonly these salts are chlorides, sulfates, or carbonates of sodium, calcium and magnesium. Rising water tables will bring these salts to the surface where they will cause vegetation to die and result in severe damage to property and the environment.
- (d) Acid sulfate soils are a major environmental problem affecting areas of land in the coastal region of NSW. They form when soils naturally containing iron sulfides are dug up or exposed to air, forming sulphuric acid. Large-scale drainage of coastal floodplains for flood mitigation, urban expansion and agriculture has exposed large areas of acid sulfate soils.

1.4.2 Cost of Degradation

- (a) While the direct costs of erosion damage are easily measured and have been well documented, the indirect costs, including those of an environmental nature are often more important, but rarely recognised and analysed. Environmental damage, for example, often accumulates slowly and produces dramatic effects only after many years. Indirect costs commonly arise from such factors as:
 - (i) degradation of urban bushland, riparian, aquatic and marine habitats often resulting in:
 - immediate and ongoing imbalances and deterioration in the local ecosystem
 - reduced aesthetic values of bushland and waterways;

- (ii) increased incidences of unacceptable levels of turbidity in drainage works, streams and other water bodies;
 - (iii) increased levels of salinity on lands and in water bodies elsewhere;
 - (iv) increased frequency and damage caused by flooding downstream and increased frequency of smaller flood events;
 - (v) erosion damage to natural channels, earthworks and constructed drainage lines; and
 - (vi) increased "down time" for developers following intense and/or extended periods of wet weather.
- (b) Research of Lake Illawarra shows that recent urban development and associated activities have caused the sedimentation rate to increase six times and the nutrient pollution rate to jump 10 times (Illawarra TCM Committee, 1989), resulting in infilling and algal blooms. Studies of Lake Macquarie conclude that sediment loadings (Table 1.1) are likely to alienate approximately 10 to 20 hectares of the lake each year. This sediment loading will have a substantial and possibly irreversible effect on this aquatic ecosystem.

Table 1.1 Estimates of sediment loadings entering Lake Macquarie (SPCC, 1983)

Year	Urban area (ha)	Catchment population	Sediment load (tonnes/year)			
			Urban	Rural / forest	Point sources	Total
pre 1800	–	na	–	6,600	–	6,600
1940	1,460	na	7,700	19,000	–	26,700
1983	110,000	102,000	58,000	16,500	500	75,000
2000 (est)	140,000	129,000	74,000	15,000	500	90,000

- (c) Another example shows the impact of urban development on water quality at a 74-hectare site at Albion Park, despite the installation of what were regarded then as acceptable erosion and sediment controls. At the site (figure 1.1), sediment concentrations increased by up to 3,000 times during the subdivision construction phase. The largest increase resulted from channel reconstruction work undertaken in late February and March, a period of very high rainfall erosivity.

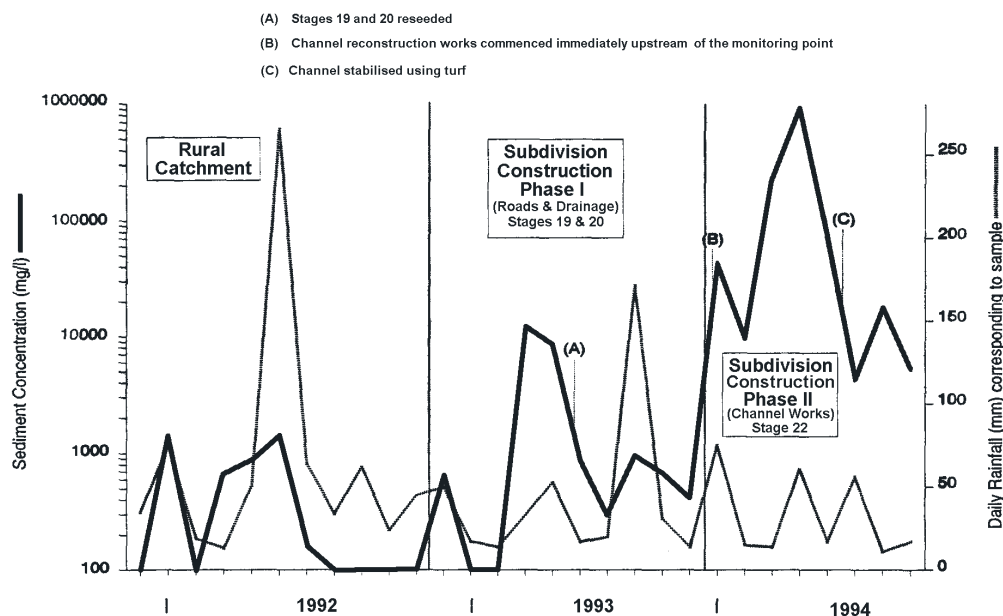


Figure 1.1 Sediment concentrations and daily rainfall at one site at Albion Park (Goldrick and Armstrong (1994))

(d) This manual provides information on planning and management of soil and water resources during any land disturbance activity. It can act as a basis for a substantial reduction in the cost of land degradation resulting from urban and rural residential development. If implemented, the guidelines facilitate maintenance and potential enhancement of the environment for current and future generations.

1.5 Ecologically Sustainable Development (ESD)

(a) The ESD definition that is the most relevant here is that developed by the ESD Steering Committee (1992), namely: ESD uses, conserves and enhances the community's resources so that ecological processes, on which life depends, are maintained and the total quality of life now and in the future can be increased. This definition of ESD can be broken into four objectives:

- sustainable quality of life
- biodiversity conservation
- pollution minimisation
- resource conservation.

The principles of ESD have been adopted by all Australian governments as the basis for policy and program development into the future.

(b) The major challenge in applying environmental policies to land identified for development is to combine the multitude of sectoral policies that affect our quality of

-
- life and the ecological balances effectively. If implemented, ESD policies can help realise the goals of a sustainable quality of life by:
- providing good opportunities for open space
 - preserving the landscape and cultural values
 - avoiding reductions in biologically significant resources of any given site
 - conserving biodiversity
 - reducing energy consumption
 - reducing pollution discharges in a local and regional perspective. These policies apply to all land, mining and infrastructure developments.
- (c) Furthermore, the cumulative impacts of all individual activities are important. Principles need to be focused so that the full importance of sustainable economic and social development for resource use and environmental quality can be encouraged.
- (d) ESD is about process as well as product. This means that the ways in which decisions are made are as important as the decisions themselves. ESD should be pursued by planners, consultants, project managers and council officers, when designing, construction and assessing new developments.
- (e) ESD can be pursued through the following initiatives:
- (i) Community participation in decision-making, especially where specific doubts might occur in relation to the environmental consequences of a project. The best examples are where communities are involved from the earliest stages in a particular planning process.
 - (ii) Life cycle costing that ensures that ESD benefits are not disadvantaged. In this, capital and recurrent costs of a particular project help decide the most appropriate alternatives on both the project and materials/technology levels.
 - (iii) Adoption of the precautionary principle. If threats of serious or irreversible environmental damage are possible, lack of full scientific certainty should not be used as a reason for postponing measures to prevent environmental degradation.
 - (iv) Environmental monitoring of key indicators (e.g. soil loss, water quality, asset deterioration, biodiversity, noise, air quality) on an ongoing basis to measure the impacts of the development on key elements of the environment.
- (f) The ESD challenge is to view local areas holistically and, in this manual, catchment and downstream impacts. It should link related physical, environmental, economic, social and cultural issues, rather than treating them separately. This creates urban forms that are more sustainable in terms of environmental impact and use of natural resources.
- (g) In planning for greater sustainability, a multilayered response to various issues is necessary (i.e. think globally, act locally, respond individually) in relation to energy consumption, air and water quality and species conservation. Ideally, the local issues

will include the control of soil degradation and soil loss during land disturbance activities and an improvement in the water quality and after they are complete.

- (h) The following are some examples of ESD that could be implemented by project managers. They are provided to make ESD more understandable:
- create buffer zones between areas of development and remnant habitats
 - remediate all contaminated land
 - protect exposed soil surfaces from degradation
 - use raw materials that have a minimal impact on human health and the environment
 - use materials that create minimal pollution and use energy efficient processes in their production
 - use materials that are recycled, renewable, recyclable or durable
 - recycle stormwater runoff to reduce the consumption of mains water
 - intercept and manage stormwater before discharge into natural watercourses
 - rehabilitate the site to increase the quality and quantity of the native habitat
 - use ecologically benign vegetation for site stabilisation
 - use locally indigenous vegetation for landscaping
 - ensure site personnel and subcontractors are inducted into the proper procedure for the site and create contractual bonds with penalties to ensure compliance with any soil and water management plan.

1.6 General Principles of Soil and Water Management

1.6.1 Background

- (a) Generally, effective soil and water management during a land disturbance phase involves the following seven principles:
- (i) assess the soil and water implications of development at the subdivision or site planning stage, including those relating to ESD. Investigate the salinity and, on coastal lands, the acid sulphate potentials of the soils where their disturbance is likely to expose and/or exacerbate this problem;
 - (ii) plan for erosion and sediment control concurrently with engineering design and before earthworks begin, ensuring proper assessment of site constraints and integration of the various components;
 - (iii) minimise the area of soil disturbed and exposed to erosion;
 - (iv) conserve topsoil for later site rehabilitation/revegetation;
 - (v) control water flow from the top of, and through the development area;
 - (vi) rehabilitate disturbed lands quickly; and

(vii) maintain soil and water management measures appropriately during the construction phase.

(b) Accordingly, it is desirable that works proceed as outlined in Figure 1.2.

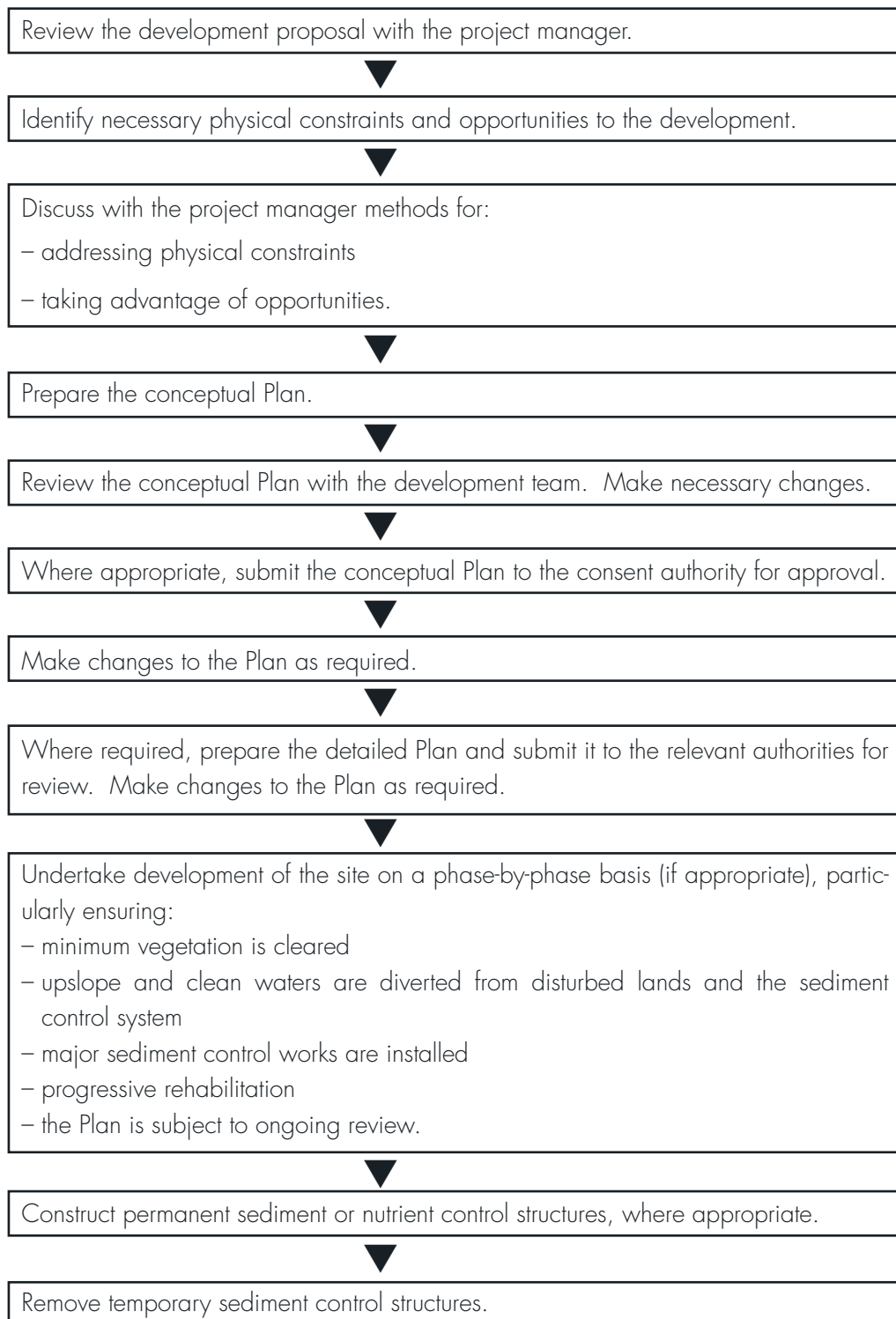


Figure 1.2 Suggested works sequence

1.6.2 The Work's Program

(a) Implementation of the principles of ESD means that planning for soil and water management will be based on an assessment of the physical constraints present at the site. These are described further in Chapters 2 and 3 and include assessments of:

- rainfall erosivity
- flooding liability
- topography
- soils (erodibility, dispersibility, salinity, shrink swell capacity, drainage characteristics, mass movement potential, etc.).

Only after such assessments have been completed at an appropriate scale is it possible to plan for soil and water management in a practical and constructive manner, and ensure adequate erosion and sediment control standards.

(b) The preparation of site development plans should:

- (i) offer solutions that ensure that any development is ecologically sustainable, being considerate of the immediate and eventual effect of development on;
 - the quality and quantity of both surface water and ground water
 - waterfront (riparian) ecosystems;
- (ii) consider the cumulative effect of each particular development program to other developments within the catchment area;
- (iii) enable a choice of soil and water management structures and strategies that should consider aspects other than just capital outlays, e.g. environmental considerations, costs relating to maintenance and replacement;
- (iv) consider the nature of any specific plan for control of soil erosion, sedimentation and pollution;
- (v) be undertaken in concept before and at the development application stage; and
- (vi) be undertaken in detail at the final engineering plan stage.

(c) It is not sufficient to retrofit erosion and pollution management strategies to developments that have essentially completed the engineering plan stage.

(d) Elements to be included in plans for soil and water management include:

- (i) The phasing of works so that land disturbance is confined to minimum areas of workable size, but consistent with the scale and economics of the development.
- (ii) Ensure correct stockpiling of topsoil (Section 4.3.2).
- (iii) Minimise the impact of runoff water on the site (Chapter 5).
- (iv) Give priority to those BMPs that mitigate soil erosion in the first place, rather than to those that capture sediment downslope or at the catchment outlet (i.e. concentrate on source controls). Diverting upslope waters around works is especially important (Chapter 5).

-
- (v) Install erosion and sediment control measures as a first step in the work's program and maintain these in an effective condition until earthworks are completed and the site rehabilitated (Chapters 5, 6 and 7).
 - (vi) Integrate soil erosion and sediment control, stormwater and pollution control works (Chapter 6).
 - (vii) Where appropriate, reduce the effects of wind erosion (Chapter 6).
 - (viii) Rehabilitate the site to ensure that disturbed lands are stabilised and integrity is maintained (Chapter 7).
 - (ix) Reduce maintenance needs and other ongoing costs by integrating all soil and water management works in the construction phase (Chapter 8).
 - (x) Ensure that all erosion and sediment control measures are kept in a functioning condition until all site disturbance works are completed and the site is rehabilitated (Chapter 8).

1.7 Legislation and Policy Requirements

- (a) The NSW planning framework under the Environment Planning and Assessment Act (EP&A Act) contains three levels of planning documents. These are:
 - (i) State Planning Policies that bring together State Government policies relating to environmental planning to:
 - provide a state context for Regional Planning
 - provide a whole of government issues based , outcome-focussed policies
 - provide the social, economic and environmental policies relevant to planning under the EP&A Act
 - provide the vision, policies and regulatory provisions to be included in local plans.They are prepared and approved by the NSW Government in consultation with the community.
 - (ii) Regional Environmental Plans that contain the regional strategy and direction for the coordination of regional policies to:
 - provide the context for regional actions and local planning
 - provide a whole of government strategy involving state and local government, business and the community
 - provide guidelines for the future development of a region, linking social, economic and environmental issues relevant to planning under the EP&A Act
 - provide the vision, policies and action plan.They are prepared by a regional forum in consultation with the community. Further, they are approved by the NSW Government and can be amended only by the Minister.

1. Introduction

(iii) Local Environmental Plans that relate to a single local government area. They coordinate actions and contain all land use controls relating to any particular site. They provide:

- the context for local actions and development assessment
- a whole of council plan, coordinating goals, policies and activities
- a guide to the future of a local area, linking social, economic and environmental issues relevant to planning under the EP&A Act
- a vision, policies, an action plan and regulatory provisions.

The plans are drawn up by the local council in consultation with the community. Further, they are approved by the local council with concurrence of the Minister for Planning.

- (b) Table 1.2 contains a listing of NSW Government key policy objectives for managing natural resources.
- (c) Table 1.3 outlines the principal roles and responsibilities of the various NSW Government agencies.

Table 1.2 Key Policy Objectives of the NSW Government and its Agencies

State Policy	Key Policy Objectives	References
Biodiversity Strategy	To protect the native biological diversity of NSW and maintain ecological processes and systems. The strategy includes initiatives relating to water reform, vegetation management and the development of a comprehensive and representative reserve system	<ul style="list-style-type: none"> • Environmental Planning and Assessment Act, 1979 • Threatened Species Conservation Act, 1995 • National Parks and Wildlife Act, 1974 • Native Vegetation Conservation Act, 1997 • Fisheries Management Act, 1994 (See Appendix H)
Coastal Policy	<ul style="list-style-type: none"> • Protection, rehabilitation and improvement of the natural environment of coastal areas • Protection and enhancement of the aesthetic qualities of the coastal areas • Protection and conservation of the cultural heritage of the coastal areas • Ecologically sustainable development and use of resources • Appropriate public access and use • Provision of information to enable effective management of coastal areas • Integrated planning and management of coastal areas 	<ul style="list-style-type: none"> • Coastal Protection Act, 1998 • NSW Coastal Policy (1997)
Waterfront Lands (Riparian Land Management)	<ul style="list-style-type: none"> • Habitat protection • Stability of River channels and foreshores • Water quality • Recreation activities • Permits are required for activities within 40 metres of the bank of a river 	Rivers and Foreshores Improvement Act, 1948 until November 2003 when it will be repealed by the Water Management Act, 2000 (See Appendix H)
Sediment and Erosion Control	<ul style="list-style-type: none"> • Prevent the loss of the soil resources from a site. Promotion of sustainable use of this resource. • Control of sediment into creeks, rivers and lakes • That the biodiversity values of the locality be maintained and enhanced 	Soil Conservation Act, 1939 Protection of the Environment Operations Act, 1997

1. Introduction

Table 1.2 Key Policy Objectives of the NSW Government and its Agencies (continued)

State Policy	Key Policy Objectives	References
Soil Salinity Strategy	<ul style="list-style-type: none"> • To minimise the impact of salinity on human land use and ecological systems • To prevent potential damage to buildings roads and services, and protect human health 	<ul style="list-style-type: none"> • Taking the Challenge - NSW Salinity Strategy (DIPNR, 2001) • Soil landscape mapping handbooks for various regions in NSW (DIPNR) • WSROC: Salinity Code of Practice (WSROC)
Acid Sulphate Soils Guidelines	<ul style="list-style-type: none"> • To prepare local plans that identifies land as having a probability of acid sulfate soil. • To encourage the adoption and implementation of acid sulfate soil guidelines in any developments 	<ul style="list-style-type: none"> • Guidelines for the use of Acid Sulphate Soil Risk Maps (DIPNR) • Acid Sulfate Soils Manual (NSW Acid Sulfate Soil Management Advisory Committee, 1998)
Wetlands Management Policy	Encourage the management of wetlands to halt loss of wetland vegetation, biological diversity, declining water quality, productivity and natural flood mitigation. Encourage the restoration and rehabilitation of wetlands	NSW Wetlands Management Policy (DIPNR, 1996)
State Rivers and Estuary Policy	Protection of estuarine habitats and ecosystems in the long term including the maintenance of the necessary hydraulic regime. Preparation of management plans for the sustainable use of each estuary	Estuary Management Policy (DIPNR) Estuary Management Manual (DIPNR, 1992)
Urban Stormwater Program	<ul style="list-style-type: none"> • Stormwater Trust Grants Scheme to improve urban stormwater quality • Urban Stormwater Education Program • Stormwater Management Plans prepared by Councils to identify problems and propose cost effective solutions 	<ul style="list-style-type: none"> • Managing Urban Stormwater: Council Handbook (EPA, 1997) • Managing Urban Stormwater: Treatment Techniques (EPA, 1997) • Managing Urban Stormwater: Source Control (EPA, 1997) • Managing Urban Stormwater – Soils and Construction (Landcom, 2003)

Table 1.2 Key Policy Objectives of the NSW Government and its Agencies (continued)

State Policy	Key Policy Objectives	References
Flood Prone Land Policy	<p>Preparation of Floodplain Management Plan and strategies of the local council that addresses each of the three flooding hazards that affect flood prone lands. These are:</p> <ul style="list-style-type: none"> • The existing risk faced by existing developments on flood prone land • The future risk which any new development will face • The continuing risk that remains after flood mitigation actions has been completed 	Floodplain Management Manual: The Management of Flood Liable Land (NSW Government, 2001)

Table 1.3 Principal Roles and Responsibilities of the Various NSW Government Agencies

Government Agency	Role and Responsibility
<p>Department of Environment and Conservation incorporating the former Environment Protection Authority, National Parks and Wildlife Service and others</p> <p>www.epa.nsw.gov.au; www.npws.nsw.gov.au</p>	<p>Legislation: Protection of the Environment Operations Act, 1997; Contaminated Land Management Act, 1997; National Parks and Wildlife Act, 1974; Threatened Species Conservation Act, 1995.</p> <p>Role & responsibility: Licensing for pollution control, various water quality guidelines, Urban Stormwater Management Program; care and management of native flora and fauna, threatened species, and Aboriginal places and relics. Can provide information on likely occurrence or location where threatened species of plants or animals can occur.</p>

1. Introduction

Table 1.3 Principal Roles and Responsibilities of the Various NSW Government Agencies (continued)

Government Agency	Role and Responsibility
<p>Department of Infrastructure Planning and Natural Resources www.dipnr.nsw.gov.au</p>	<p>Legislation: Environmental Planning and Assessment Act, 1979; Heritage Act, 1977; Water Management Act, 2000; Soil Conservation Act, 1938; Native Vegetation Conservation Act, 1997; Rivers & Foreshores Improvement Act, 1948.</p> <p>Role & responsibility: NSW Planning Framework, State Planning Policies, approving regional strategies and local environmental plans, NSW Coastal Policy, providing development consent. Management and protection of the water resources of the State including: licensing of extraction of water, diversions or damming of a river, wetlands; management of riparian land and issue of Part 3A Permits; erosion and sediment control plans; floodplain management plans; native vegetation management and issue of development consent for clearing. Provides expertise on erosion control, revegetation, dryland salinity and acid sulfate soils</p>
<p>NSW Fisheries www.fisheries.nsw.gov.au</p>	<p>Legislation: Fisheries Management Act, 1994</p> <p>Role & responsibility: Protect aquatic habitats and species; prevent the destruction of fish habitat, the alteration of natural flow regimes of streams, installation of in stream structures that modify flow and restrict fish passage, the removal of large woody debris; the protection of aquatic and riparian vegetation; the reconstruction of habitats including wetlands; and estuary management</p>
<p>Local Councils</p>	<p>Legislation: Local Government Act, 1993; Local Government Amendment (ESD) Act, 1997; Noxious Weeds Act, 1993; Environmental Planning and Assessment Act, 1979.</p> <p>Role & responsibility: Exercise controls over urban development through the implementation of state environmental policies promulgated in REPs, LEPs DCPs and making development application approvals. Local Government has an increasing role in natural resource management, e.g. preparation of noxious weeds lists</p>



Chapter 2

PLAN PREPARATION

2. Plan Preparation

2.1 Background

- (a) Building and development/subdivision works usually require plans or other documents that describe the measures to be undertaken at development sites that, if carried out, should mitigate soil erosion and control discharge of sediment, nutrients and other pollutants to lands and/or waters during works. Typically, these plans contain:
- one or more drawings on which are delineated the layout of appropriate soil and water management works
 - a commentary that might be presented as a separate report and/or on one or more plan sheets that contain supporting text, calculations and diagrams.
- (b) One of two kinds of plans should be prepared before land disturbance activities occur on any non rural lands where more than 250 square metres are involved. These are either an *Erosion and Sediment Control Plan (ESCP)* or a *Soil and Water Management Plan (SWMP)*.
- (c) The focus of these Plans is erosion and sediment control during the land disturbance phase of development. A separate Plan (e.g. an Integrated Water Cycle Plan) is typically required to address post-construction stage stormwater management. Clearly, these Plans need to be developed in a complementary and integrated manner.
- (d) Where less than 250 square metres are being disturbed, no formal plan is required (Table 2.1). However, developers should check with their local consent authority and, in any case, exercise reasonable care where land degradation or pollution to receiving waters or drainage channels might occur.

Table 2.1 Suggested Plan Type

Area of disturbance (m ²)	Nominal type of activity	Suggested type of plan
< 250	house extensions, small driveways, garages	check with local council
250 – 2,500	most houses, long driveways, commercial developments, small subdivisions, small medium/high-density housing, small civil works	ESCP addressing soil erosion and sediment pollution only
> 2,500	large subdivisions, large medium/high- density housing, large civil works.	SWMP addressing soil erosion and sediment pollution, including a calculation as to the need for a sediment basin

-
- (e) *ESCPs* should be prepared on smaller sites, such as, where more than 250 but less than 2,500 square metres of land will be disturbed. This can include:
- (i) minor developments where approval is required from the consent authority; and
 - (ii) minor civil infrastructure works, including:
 - urban and rural road construction and reconstruction
 - stormwater pipelines, including culverts
 - sewerage pipelines
 - water pipelines
 - bulk earthworks, including retention basins and sports fields
 - electricity, telephone and natural gas lines.

Nevertheless, the consent authority might vary this requirement especially where, in their view:

- a high risk of polluting receiving waters exists, i.e. require a *SWMP* or
 - a very low risk of polluting receiving waters exists, i.e. waive the need for an *ESCP*.
- (f) *SWMPs* generally should be prepared for all development works where more than 2,500 square metres of land will be disturbed and/or where development consent is required^[1].
- (g) Also, several Councils have prepared their own guidelines for the preparation of *ESCPs* and *SWMPs* that should be followed. These Guidelines can contain practices that are specific to addressing special situations that exist in their area, such as highly erodible sandy soils or preventing pollution to coastal lakes.

2.2 Erosion and Sediment Control Plans (*ESCPs*)

- (a) All *ESCPs* should contain a drawing that clearly shows the site layout and, where appropriate, the approximate locations of BMPs and other matters listed in (b) and (c), below. Where these drawings are to scale, the scale should be at 1:500 or larger. A narrative should accompany the drawing that describes how erosion control and soil and water management will be achieved on site, including ongoing maintenance of structures.
- (b) The following background information should be presented on the drawing(s):
- location of site boundaries and adjoining roads
 - approximate grades and indications of direction(s) of fall
 - approximate location of trees and other vegetation, showing items for removal or retention (consistent with any other plans attached to the application)

1. Many smaller sites requiring *SWMPs* do not require sediment control basins or wetlands. Nevertheless, the need or otherwise should be investigated and conclusions should be clearly documented.

2. Plan Preparation

- location of site access, proposed roads and other impervious areas (e.g. parking areas and site facilities)
 - existing and proposed drainage patterns with stormwater discharge points
 - north point and scale.
- (c) On the drawing or in a separate commentary, show how the various soil conservation measures will be carried out on site, including:
- timing of works
 - locations of lands where a protective ground cover will, as far as is practicable, be maintained
 - access protection measures
 - nature and extent of earthworks, including the amount of any cut and fill
 - where applicable, the diversion of runoff from upslope lands around the disturbed areas
 - location of all soil and other material stockpiles including topsoil storage, protection and reuse methodology
 - location and type of proposed erosion and sediment control measures
 - site rehabilitation proposals, including schedules
 - frequency and nature of any maintenance program
 - other site-specific soil or water conservation structures.
- (d) Further information on the preparation of *ESCPs* for particular land disturbance activities is detailed in Chapters 9 and Volume 2 of these guidelines and in a separate field guide giving an example of an *ESCP* for the construction of single dwellings.

2.3 Soil and Water Management Plans (SWMPs)

2.3.1 Important Considerations

- (a) The design objectives of any *SWMPs* should be influenced by competing land use requirements or sensitivities, such as those of other members of the development team (e.g. designers, engineers, town planners, landscapers, ESD consultants, etc.) and others affected by the development, including:
- council policies (e.g. DCPs)
 - council's stormwater plan and/or visions for stormwater management
 - community requirements
 - various government policies and initiatives (e.g. SEPPs, REPs, etc.).

Consequently, any consultant(s) involved in *SWMP* preparation should liaise closely with the project manager or development coordinator to identify the planning needs, constraints and choice of BMPs. Undertake such liaison at the design concept stage and, where appropriate, concurrently with trunk drainage investigations. It is

expected that the requirements of each of these factors will modify the planning for the others so that soil and water management needs are clearly integrated into the development process.

(b) Procedures should provide a mechanism for feedback between those preparing SWMPs and those preparing many other plans for the works. In an urban situation, for example, this might include:

- works in or close to a watercourse
- layout of lots, roads, cycle and pedestrian access corridors
- provision of recreation facilities, public open space, or natural heritage reservations
- drainage of stormwater
- provision of services
- rehabilitation of the site.

In planning for an integrated development, these and other requirements will influence and modify planning for each other; soil and water management should not be an ad hoc add-on option. This is particularly important on larger sites (>1,000 square metres to be disturbed). The integration of soil and water management works with the construction program might result in a reduction in maintenance needs.

(c) Further, the various development design processes should integrate engineering and soil and water management planning. Prepare the SWMPs at the same time as engineering design for all construction works and include them as part of the final engineering plans. Once engineering plans are complete, integration can be very difficult to achieve. Cross referencing soil and water management planning with site rehabilitation is also important.

(d) Generally during construction, any SWMP should seek to achieve adequate control for:

- (i) pollution of sediment and other coarse material up to the maximum permitted suspended solid concentration for a defined storm or rainfall event as specified by relevant local government authority in a Stormwater Management Plan and discussed in *Managing Urban Stormwater: Council Handbook (EPA 1997a)*; and
- (ii) stability of soil and water management structures for all up to the design storm events.

(e) The design storm event for the stability of structures is usually taken as the 10-year ARI time of concentration storm event. Clearly, larger design events can be more appropriate where, for example, the costs of failure of structures warrant it or where required by a local council. Smaller design events are not recommended and should be fully justified. Justification can include situations where the risk of sediment pollution should failure occur is offset by other measures.

2. Plan Preparation

- (f) Any *SWMPs* should reflect maintenance considerations, especially:
- (i) those that might preclude the use of certain soil and water management measures (e.g. provision of adequate access, likely uses of mechanical equipment, etc.);
 - (ii) flocculation;
 - (iii) performance and review; and
 - (iv) ongoing needs throughout and beyond the development phase.
- (g) *SWMPs* should reflect the need for changes or modifications to their requirements as development progresses. Revised *SWMPs* might be required where:
- (i) changes occur in slope gradients and drainage paths, with their exact form frequently unpredictable before works start;
 - (ii) works continue over an extended period, with revisions being required at the beginning of the second year of operations and further revisions at 2-yearly intervals after that. Of course, any revised *SWMPs* should reflect reasonable new standards applying then; and
 - (iii) the desired outcome (e.g. protection of receiving waters) is clearly not being achieved. The *SWMP* is only part of the management strategy with other aspects being appropriate implementation, monitoring and corrective action.

Normally, changes are not expected. Where required, only a suitably qualified person, ideally the person who prepared the original *SWMP*, should undertake such changes.

- (h) The *SWMP* should:
- (i) be submitted to the relevant authorities for review and comment before appropriate development consent, building approval or other permits/approvals are received;
 - (ii) contain both a report and a plan of works and should link directly with other plans, reports and documents as appropriate;
 - (iii) form part of the final engineering design drawings; and
 - (iv) be documented in the:
 - construction plans and/or
 - Schedule of Rates or Bill of Quantities.
- (i) Plans are normally submitted at two levels: conceptual and detailed. Conceptual plans contain all criteria necessary for a consent authority to make a reasonable decision about whether a proposal could be supported or not. Normally, conceptual plans do not contain engineering drawings of structures. Once the development is approved, a detailed plan should be prepared and submitted before works start, showing clearly all necessary engineering information. The *SWMPs* shown in Chapter 9 are conceptual.

2.3.2 Data Input

- (a) *SWMPs* should be based on an assessment of:
- (i) the physical constraints and opportunities to development at the particular site, including those for soil, landform type and gradient, and hydrology (Chapter 3). Accordingly, the soil and water management team should include members with relevant tertiary qualifications or proven skills recognised by the appropriate authorities;
 - (ii) appropriate measures to overcome those constraints and take advantage of opportunities, including options for:
 - staging of works
 - mitigation/control of on site soil erosion
 - movement of water onto, through, and off the site
 - rehabilitation/maintenance of the works area; and
 - (iii) the way that works will modify the landscape and surface and subsurface drainage patterns (adding new, or modifying existing constraints). In this regard, the *SWMPs* should result from a consideration of layout options, each of which harmonise with the overall planning strategy and with each assessed for economy, aesthetics, function, and ESD criteria.
- (b) In addition to all the data required for *ESCPs* (Section 2.2), *SWMPs* require:
- (i) the following information:
 - the location of lots, public open space, stormwater drainage systems, schools, shopping/community centres
 - the location of land designated or zoned for special uses
 - existing site contours^[2];
 - (ii) the location and general diagrammatic representations of all necessary:
 - erosion and sediment control BMPs;
 - (iii) location and engineering details with supporting design calculations for all necessary:
 - sediment basins; and
 - (iv) location and basic details of any other facilities proposed to be included as part of the development or works, such as:
 - constructed wetlands
 - gross pollutant traps
 - trash racks or trash collection/separator units
 - “water sensitive” stormwater treatment measures, such as bioretention systems, vegetated swales and infiltration measures.

2. Recommended contour interval is 0.5 metres on gradients of less than 15 percent, 1 metre on gradients of 15 to 30 percent and 2 metres for slopes >30 percent.

2. Plan Preparation

Detailed design criteria for these latter facilities should be sourced from other manuals/reports and are not an integral part of a construction phase *SWMP*. Usually they are considered as a separate function of the development approval process.

Note that the above listed works should not be located in or very near to watercourses. This is to avoid compromising the values and functions of the watercourses and their current or future riparian zones.

- (c) Inspection and Test Plans (ITPs) should be presented as an element of all *SWMPs*. ITPs are documents that detail the inspection, testing and acceptance requirements for specific activities such as those associated with land development. They help with the management and overall control of the work's program. ITPs should:
- relate to specific works at particular locations
 - reflect the needs of individual organisations
 - reflect the requirements nominated in specific contracts.

Within this context, they should identify:

- the activity to be undertaken
- the standard or specification compliance that is being sought
- the relevant acceptance criteria the method of inspection and/or test and the frequency at which it is to be performed
- who is responsible for carrying out the inspection and/or test
- what documentation is to be produced as a record of the inspection and/or test.

They should also identify any "witness" or "hold points" required during the works. Witness points are stages at which activities are to be observed while hold points are stages beyond which work must not proceed without authorisation. Figure 2.1 is a sample ITP produced for the construction of a typical residential dwelling and its format should only be regarded as a guide.

- (d) Further information on the preparation of *SWMPs* for urban subdivisions is detailed in Chapter 9 of this document. Guidance in the development of *SWMPs* for other development types or activities (e.g. mines, quarries, waste landfills, construction of highways and main roads, installation of services, is provided in Volume 2 of *Managing Urban Stormwater: Soils and Construction*.

INSPECTION AND TEST PLAN

PROJECT: DWELLING CONSTRUCTION EROSION AND SEDIMENT CONTROL (LOTS LESS THAN 2,500M ²)		INSPECTION TEST PLAN NO: QAIT001		PAGE 1 OF 2						
DEVELOP EROSION AND SEDIMENTATION CONTROL PLAN IF NOT PROVIDED IN THE CONTRACT DOCUMENTS		CONTROLLED COPY NO:		REV: 0						
STEP	INSPECTION ACTIVITY	APPLICABLE STANDARD	ACCEPTANCE CRITERIA	METHOD	TEST FREQ.	INSPECTORATE SUB	CON	SUP	RECORDS/REMARKS	AREA
1	Review Erosion and Sedimentation Control Plan (ESCP)	Chapter 2.0 Chapter 3.0	Plan to minimum scale of 1:2000, locality, contours (initial and final), land slope gradients, critical natural areas (eg. streams and cliffs), catchment boundaries, location of roads and impervious surfaces, existing vegetation and site drainage shown. Limit of clearing, grading and filling defined, location of topsoil stockpiles shown, erosion control practices and sediment control practices Details of site revegetation programme and outline of programme for maintenance of erosion and sediment controls included.	Review	Before start	X			File note of ESCP review	
2	Review construction program	Chapter 3.0	Construction of control measures shown completed prior to commencement of work on site. Clearing and grading integrated with design layout, limited to areas of work in progress and staged to immediately precede construction activities. Permanent stormwater drainage works installed as first stage of land development. Installation of utilities coordinated.	Review	Before start	X			File note of construction program review	
3	Confirm all approvals received	Contract documents	Superintendent approval of ESCP, construction program and subcontractors received. Relevant Authority approvals received.	Review	Before start	H			File note of document review. Superintendent's letter of release from Hold Point	
4	Confirm site erosion and sediment control measures in place	Chapter 5.0 Chapter 6.0 Chapter 9.0	Stabilised access, stormwater filters, sediment filter fences, channels, earth banks and level spreader properly located and constructed. Surface flows directed over areas with vegetation to sediment fences.	Visual	Before excavation	H			Site diary note of inspection. Superintendent's letter of release from Hold Point	

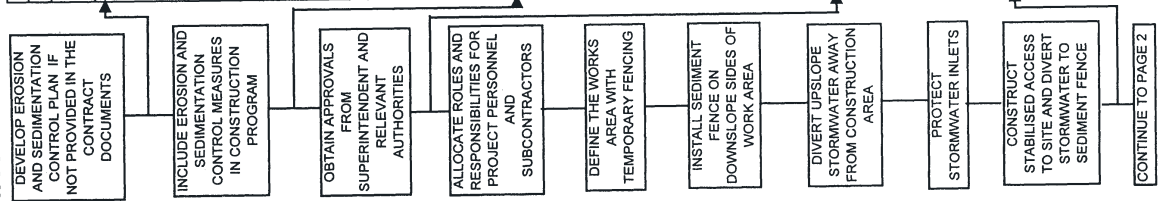


Figure 2.1a

INSPECTION AND TEST PLAN

PROJECT: DWELLING CONSTRUCTION EROSION AND SEDIMENT CONTROL (LOTS LESS THAN 2,500M ²)		INSPECTION TEST PLAN NO: QAIT001		PAGE 2 OF 2							
COMMENCE ROUTINE INSPECTION OF CONTROL MEASURES		CONTROLLED COPY NO:		REV: 0							
STEP	INSPECTION ACTIVITY	APPLICABLE STANDARD	ACCEPTANCE CRITERIA	METHOD	FREQ.	TEST	INSPECTORATE	RECORDS/REMARKS	AREA		
							SUB	CON	SUP		
5	Check condition of erosion and sediment control measures	Chapter 8.0	Inspection of erosion and sediment control measures carried out weekly, whenever storms are forecast, during storms and after storms have subsided. Damaged control measures repaired and accumulated sediment removed to non-erodible locations.	Visual	Weekly	Storms	X			Site diary note of inspections	
6	Confirm building area erosion and sediment control measures in place	Chapter 4.0 Chapter 6.0 Chapter 9.0	Topsoil stockpile, sediment filter fence, channels and earth banks properly located and constructed. Surface flows directed to single outlet and dispersed through sediment fence. Topsoil stockpile stabilised.	Visual	Before start		W			Site diary note of inspection	
7	Inspect trench restoration	Chapter 9.0	Trenches backfilled and compacted on completion. Restoration carried out to pre-existing condition.	Visual	At finish		X	S		Site diary note of inspections Service installation Inspection and Test Plan	
8	Check storage of materials	Chapter 9.0	All materials stored within site sediment fence.	Visual	Weekly			X		Site diary note	
9	Inspect site restoration	Chapter 4.0 Chapter 7.0 Contract Documents	Ground prepared, treated and topsoil applied to specified depth. Plants, turf and seeding placed in accordance with landscape plan.	Visual	At finish		X	S		Site diary note of inspections Landscape Inspection and Test Plan	
10	Final inspection	Contract documents	Disturbed areas reinstated, landscaping in accordance with plan, vegetation healthy and temporary sediment control structures removed.	Visual	At finish		X	W		Site diary note	
LEGEND:		SUB - SUBCONTRACTOR	CON - CONTRACTOR	SUP - SUPERINTENDENT			H - HOLD POINT		Boxes to be initialised and dated when activity for each area has been satisfactorily completed		
REFERENCE DOCUMENTS:		X - WORK ACTIVITY	S - SURVEILLANCE	W - WITNESS POINT			ISSUED TO:		REVISION:		
MANAGING URBAN STORMWATER: CONSTRUCTION MANUAL		AUTHORISED BY:				DATE:					

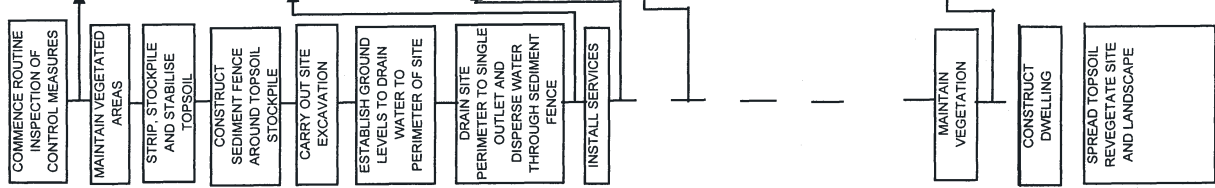


Figure 2.1b



Chapter 3

ASSESSMENT OF CONSTRAINTS AND OPPORTUNITIES

3. Assessment of Constraints and Opportunities

3.1 Introduction

- (a) Proper assessment of site constraints and opportunities is a prerequisite to any *Soil and Water Management Plan (SWMP)*. These constraints and opportunities can be classified into two groups:
- (i) those at the site, relating to the soil, landform, ecology, pollutants and hydrology; and
 - (ii) those downstream, relating to aquatic ecosystem sensitivity and the social and aesthetic values of the community.
- (b) The assessment:
- (i) identifies the nature and degree of the constraints and opportunities relevant to the specific form(s) of intended land use;
 - (ii) suggests general site-matched measures that address those constraints and opportunities and can be incorporated into plans for soil and water management; and
 - (iii) offers recommendations to maximise ESD outcomes and prevent degradation of the soil and water resources, and the aesthetic and other environmental assets.
- (c) Accordingly, in the study team that undertakes the assessment, one or more members should have appropriate tertiary qualifications or proven skills. These skills should be recognised by the relevant authorities and most likely will include soil science, geomorphology, civil engineering and ecology. Members of the team should have an understanding of ESD.^[1]
- (d) Generally, the assessment is undertaken at the design concept stage because it helps identify the best soil and water management practices necessary to achieve water quality goals. Some of these practices are structures that require space for optimum function and can require minor modification to the development layout.
- (e) At larger “green field” sites, the site assessment information might also be used to derive land capability (Section 3.4). Land capability is the systematic arrangement of land into various categories according to their capability to sustain particular uses without degradation. It gives the planner resource information to optimise the development opportunities of a site, to integrate solutions to overcome constraints, and to implement water sensitive urban design principles to manage stormwater effectively. It is important to cross reference soil and water management planning with site rehabilitation. Further information on the application of water sensitive urban

1. Various accreditation programs are now available. Three examples are:

- Chartered Professional Engineer (CPEng) offered by the Institution of Engineers, Australia
- Certified Professional in Erosion and Sediment Control (CPESC) offered by the International Erosion Control Association
- Certified Professional Soil Scientist (CPSS) offered by the Australian Society of Soil Science.

design principles in response to identified site constraints is provided in the *Managing Urban Stormwater: Urban Design* document.

3.2 Site Constraints

Some important constraints that should be assessed at nearly all land disturbance sites are listed below. The list should not be considered complete, but does identify those constraints necessary to the interpretation of these guidelines that can help minimise land degradation and water pollution at any particular site.

3.2.1 Waterfront (riparian) Lands

- (a) Waterfront Lands (formally known as Riparian Lands under the Rivers and Foreshores Improvement Act 1947 (to be repealed)) are those vegetated lands immediately next to waterbodies such as rivers, creeks, estuaries, lakes and wetlands (Appendix J). The vegetation is usually different to that growing further away and reflects the different soils (usually alluvial or littoral) and moisture regimes. The distance the Waterfront Land occurs away from a waterbody varies greatly, depending on factors such as the nature of the waterbody, the local geology and landform. Developments proposed on these lands will require a Controlled Activity Approval under the Water Management Act 2000.
- (b) Development on Waterfront Land should be constrained:
 - (i) to protect and enhance the social, economic, cultural, spiritual and heritage values of waterfront land for Aboriginal groups and the wider community; and
 - (ii) to avoid or minimise land degradation, including soil erosion, compaction, geomorphic instability, contamination, acidity, waterlogging, salinity hazards and decline of native vegetation.

Where lands were degraded before development, they should be rehabilitated if practical to do so.

3.2.2 Flooding

- (a) At the planning stage for urban developments, it is essential that the flood prone lands are identified as a component of the site assessment process. Flood assessments should distinguish between local overland flooding and mainstream flooding. In general terms, the assessments should identify the 2-year ARI flood level (Section 5.2) to help planning for erosion control, especially if an area might be subject to high velocity flows during the land disturbance process.

3. Assessment of Constraints and Opportunities

3.2.3 Rainfall Erosivity

- (a) The rainfall erosivity factor, R , is a measure of the ability of rainfall to cause erosion. It is the product of two components: total energy and maximum 30-minute intensity for each storm. In New South Wales, it varies from about 750 in parts of the Western Division to over 10,000 on parts of the far North Coast. This means erosion hazard varies more than 13-fold across the State, all else being equal. Relatively large variations can occur over quite short distances. Near Kiama, for example, it varies from 9,000 on the escarpment to 4,000 on the coast only 25 kilometres away. Rainfall erosivity is described in detail at Appendix A.
- (b) In some areas in eastern Australia, rainfall erosivity does not vary much throughout the year. Such areas usually have quite low rainfall erosivities (Appendix B) so, in relative terms, erosion hazards are low. However, local rainfall statistics in many other areas show marked seasonal trends, sometimes accompanied by quite high rainfall erosivities. In such areas, land disturbance programs should take advantage of this statistical information and encourage activities on lands with high erosion hazards or within the 2-year flood line to be undertaken in "drier" months. This risk-based approach recognises that unseasonable rainfall events might occur at unexpected times, both from one year to another and seasonally and is described in more detail in Section 4.4.2.

3.2.4 Soil Erodibility

- (a) Soil erodibility is a measure of the susceptibility of individual soil particles to detachment and transport by rainfall and runoff. Soil texture is the principal component affecting soil erodibility, but structure, organic matter and permeability also contribute (Appendix A). Usually, soil erodibility is a quantitative value experimentally determined from a soil sample in a laboratory. In Eastern Australia, it varies commonly from 0.005 to 0.075 – a factor of 15.
- (b) In Eastern Australia, soil erodibility commonly varies by a factor of 4 or 5 over very short distances – as little as two or three kilometres. Such changes are usually accompanied by changes in soil types. Because structure, organic matter and permeability contribute to it, soil erodibility can change significantly on any particular soil over a few months through changes in management practices.

3.2.5 Soil Erosion Hazard

- (a) Soil erosion hazard refers to the susceptibility of a parcel of land to the prevailing agents of erosion. The control of the soil erosion hazard at a construction site should be a primary tool in the local council's Stormwater Management Plan. The "Soil Loss Class" is a measure of erosion hazard that underpins the erosion control aspects of these guidelines and is described in detail in Table 4.2.

-
- (b) Soil erosion hazard must be distinguished from soil erodibility. Soil erodibility is measured only on a sample of soil taken from the field to a laboratory and put through certain tests; soil erosion hazard is considerate of field conditions and is dependent on a number of factors, including climate (rainfall erosivity), landform, soils (soil erodibility), ground cover and land management.
 - (c) Effective identification of erosion hazards by a soil survey or other site assessment will enable good planning and land disturbance practices to be implemented. Such practices minimise costs to the developer and, in the longer term, to the wider community. Major costs from soil erosion following storm events over disturbed lands are borne by the community through council rates used to repair adversely affected facilities. For example, sediment, the byproduct of soil erosion, blocks stormwater pipes, reduces the capacity of drainage channels, and exacerbates the impact of other pollutants, especially where it contains significant quantities of dispersible fines (Section 3.2.6). At many sites, individual land owners often have to bear considerable cost by importing topsoil for landscaping or to establish gardens where these have been denuded by soil erosion.

3.2.6 Dispersibility

- (a) Dispersible soils are structurally unstable in water and readily split into their constituent particles resulting in turbid water that never seems to clear. The particles can stay in suspension for very long periods, mainly because of negative electrical charges on the surfaces of particles finer than 0.005 mm diameter that cause them to repel each other. Some clay types have relatively few negative charges on their surfaces; some have moderate amounts while others have many charges. Many NSW clays have these charges and, consequently, are dispersible.
- (b) The negative surface charges also attract cations (including heavy metals), and phosphorous and ammonium ions. The dispersed clays and silts can carry these pollutants “piggyback” through sediment control structures unless flocculation occurs first.
- (c) Those soils regarded as significantly dispersible are those where more than 10 percent of the whole soil fraction is affected. That is, where the percentage of clay (materials < 0.002 mm) plus half the silt (roughly those materials between 0.002 and 0.005 mm) multiplied by the dispersion percentage (Ritchie, 1963) is equal to or greater than 10 (Section 6.3.3(e)).
- (d) The process of dispersion can be reversed by shifting the electrical balance through the application of positive ions to the water. This causes the dispersed fines to come together into larger units or “flocs” that can either settle in a reasonable time or be filtered – a process called flocculation. Flocculation occurs naturally under certain conditions, such as are found in estuaries, saline springs and wetlands; chemical

3. Assessment of Constraints and Opportunities

flocculants can be added to sediment basins to help settle dispersed fines (Appendix E).

- (e) While both the Emerson Aggregate Test (Emerson, 1967) and Dispersion Percentage tests suggest whether a soil material will disperse, the Emerson test also provides insight to the conditions under which it will disperse. For example, some soil aggregates disperse after being gently placed in water, while others require remoulding or shaking in a 1:5 aggregate:water suspension. In the field, soils that require remoulding to disperse are not usually a major problem unless found in positions where they might be pulverised when wet, such as on access roads.
- (f) Further, the Emerson tests shows whether soils slake whereas the Dispersion Percentage test does not. Soils that slake break down in water but do not go into suspension as do dispersible soils, i.e. the particles settle relatively quickly. Soils that slake are much more erodible than those that do not and require special attention in erosion control programs.

3.2.7 Soil Texture Group

- (a) Soil texture group is determined by the size distribution of mineral particles finer than 2 mm. There are various methods commonly used to derive particle size, however the one recommended here involves:
 - crushing
 - end-to-end shaking with a dispersant (usually Calgon)
 - sieving
 - sedimentation, measured with a hydrometer.
- (b) Particle size influences several aspects related to management of soil and surface waters. For example, the effectiveness of sediment retention structures at any particular site is greatly influenced by the nature of the soil materials at the sediment source, e.g.:
 - the finer particles (<0.02 mm) can pass through most sediment fences
 - clays and silts take much longer to settle than sands in sediment retention basins, if at all.
- (c) Particle size ranges are based on the international scale (Hazelton and Murphy, 1992):
 - less than 0.002 mm – clay
 - 0.002 mm to 0.02 mm – silt
 - 0.02 mm to 0.2 mm – fine sand
 - 0.2 mm to 2.0 mm – coarse sand.
- (d) Subsoils can be grouped into three categories according to the total of the dispersed soil percentage and the proportion in the clay and silt sizes (i.e. <0.02 mm) (it is the subsoils that are most available for erosion on construction sites) as follows:

-
- (i) “*Type D*” soils that contain a significant proportion of fine (<0.005 mm) “dispersible” materials that will never settle unless flocculated.

The other two categories cover those soils that are not dispersible:

- (ii) “*Type C*” soils, the bulk of which are coarse-grained (less than 33 percent are finer than 0.02 mm) and will settle relatively quickly in a sediment retention basin; and
- (iii) “*Type F*” soils, the bulk of which are fine grained (33 percent or more are finer than 0.02 mm) and require a much longer “residence ” time to settle in a sediment retention basin.
- (e) Section 6.3.3 requires designs for sediment basins where the soils are *Type F* and *Type D* to be based on total storm capture, while those for *Type C* have much simpler criteria and can normally surcharge. Sediment basins on *Type D* soils require flocculation, while those on *Type F* soils do not.
- (f) Sediment control on *Type F* soils is more complicated and greater emphasis should be placed on erosion control. Section 7.1.2 provides guidelines on how this can be achieved.
- (g) Some soils are strongly stabilised by iron, meaning that many particles, especially the finer ones, clump together as small aggregates under natural conditions. This reduces the proportion of clay-sized materials and increases the proportion of silts and fine sands in the particle size analysis. Such soils should be mechanically dispersed when undertaking particle size analysis — chemical dispersants such as Calgon should not be used. Remember, too, that chemical dispersants do not normally fall with rainfall, so always use mechanically dispersed data in erosion and sediment control considerations, e.g. to derive the K-factor and assessing whether the soils are *Type F* or *Type C*.

3.2.8 Expansive or Reactive Soils

- (a) Most soils shrink or swell depending on changes in their moisture content. Soils that significantly shrink on drying and swell on wetting can cause problems for many structures, including earth-walled sediment basins, buildings, services and roads. They are called expansive or reactive soils. Whether soils are expansive or reactive depends upon their clay content and mineral types.
- (b) Day-to-day variations in shrinkage and swelling can be affected by any factor that changes soil moisture levels including:
- rainfall
 - evaporation demands
 - the presence of tree roots, leaking pipes and groundwater seepages.

Of course, the effect of each of these at any particular time is constrained by antecedent soil moisture conditions.

3. Assessment of Constraints and Opportunities

- (c) Linear shrinkage is one way of measuring the one-dimensional shrinkage of a soil placed in a mould at its liquid limit, then oven-dried at 105°C for 24 hours. It is expressed as a percentage of the original dimension and suggests the relative shrink-swell potential of a soil. Problems can occur in interpreting results where the soil is dispersible (Mills *et al.*, 1980) (Section 3.2.5). General information on interpreting linear shrinkage is in Charman and Murphy (2000).
- (d) In the field, expansive or reactive soils can be identified when dry by surface features such as cracks that are 6 mm or more wide, 300 mm or more deep and at least one crack occurs per square metre. Usually, such soils have medium to heavy clay subsoils and depths greater than 500 mm.

3.2.9 Runoff Coefficient

- (a) Accurately predicting the coefficient of runoff from construction sites is essential because the information is used in several key calculations, including sizing of sediment basins. Two types of runoff coefficient may need to be considered. Conventional “peak flow” runoff coefficients apply to the design of certain structures, such as stormwater conveyance systems and sediment basins on *Type C* soils. “Volumetric” runoff coefficients, which express the fraction of rainfall expected to run off, are employed in the design of sediment basins on *Type F* and *Type D* soils. Each of these parameters vary from site-to-site and from time-to-time in response to:
 - catchment shape, size and slope
 - drainage patterns
 - surface condition, soil type and vegetative cover
 - rainfall depth and/or intensity.
- (b) Different ways of estimating coefficients of runoff have developed to deal with different applications. These apply to natural (rural) catchments, urbanised catchments and highly disturbed catchments, including construction sites. These are outlined at Appendix F.

3.2.10 Unified Soil Classification

- (a) The Unified Soil Classification System (USCS) is an engineering classification based on the particle size distribution and the characteristics of the soil’s fine fraction (Corps of Engineers, 1947). It is particularly relevant when applied to those materials used in engineering structures, such as sediment retention basins and other soil conservation structures.
- (b) The USCS has a major advantage over many other systems in that soils can be easily classified by experienced persons in the field. However, it does require an understanding of soil properties that are beyond the scope of these guidelines. For further information on the system, refer to Charman and Murphy (2000).

3.2.11 Soil pH

- (a) Soil pH is a measure of the acidity or alkalinity of a soil. It relates to the concentration of the hydrogen ions (H^+) in the soil solution measured on a negative logarithmic scale of 1 to 14. The concentrations of hydrogen ions are equal to the hydroxyl ions (OH^-) at pH 7, greater below pH 7 (acid) and fewer above (alkaline).
- (b) In the urban environment, the importance of pH is usually confined to its effect on the availability of elements in the soil and, therefore, possible deficiencies and/or toxicities. Whether these elements are available to plants depends on their solubilities, being available only when in soluble forms. Solubilities of different elements vary according to pH. Most "essential" plant nutrients are in their most soluble forms around pH 6 to 7.
- (c) Soils in NSW commonly have pH levels from 4.5 to 5.5. At these levels, Hazelton and Murphy (1992) suggest that many nutrients essential for plant growth have very low solubilities. However, native plant species have adapted to these conditions and can obtain sufficient nutrients to sustain growth; most exotic plant species do not have this ability and cannot survive. Consequently, altering the pH by artificial methods can result in an "invasion" by exotic weeds.
- (d) Lime can be used to amend low soil pH problems. However, this might not solve other nutrient concerns if the elements are deficient anyway – it simply ensures that the elements are in a form available to plants for growth. Note, too, that lime is a flocculent (Section 3.2.6, Appendix E).

3.2.12 Watertables

- (a) In Australia, permanent watertables are found in most places if one bores deep enough. They are easily identified because free water flows into the bore hole. Many plants cannot grow in the watertable or the 500 to 800-mm capillary fringe above them because of reduced aeration and, often, the presence of high levels of soluble salts.
- (b) However, another type of watertable can also occur that is not so easy to identify because free water is not always present. The movement of water in upper soil layers can be impeded by relatively impermeable layers of clay or rock fairly close to the surface. Here, perched watertables can form, sometimes seasonally following weather patterns, other times more regularly following changes in land uses and vegetative cover. Soil scientists can identify the presence of these perched watertables, even if they are intermittent or seasonal. More often, they are identified by various soil-related features such as certain soil colours and the presence of mottles rather than by free water.

3. Assessment of Constraints and Opportunities

- (c) The design of various soil and water management works can be influenced by the presence of watertables near the surface, no matter whether seasonal or permanent. This is especially important for consideration of management practices that rely on vigorous plant growth because many plants will not grow well where salt levels are relatively high or in reducing conditions, even if such conditions are only seasonal. In addition, the foundations for many structures can be affected adversely if excessive moisture fluctuations occur in their vicinity.

3.2.13 Salinity

- (a) Salinity results from the accumulation of soluble salts on the soil surface. Commonly these salts are chlorides, sulfates or carbonates of sodium and magnesium. The source of the salts is variable, but can be attributed usually to mineral weathering of marine sedimentary rocks and to saline wind-borne particles. Watertables either natural or induced can increase the potential of salinity to occur. When changes in land uses result in an impediment to drainage in the soil profile or an overall upward movement of water in the soil profile, these salts are brought into the root zone.^[2]
- (b) Salt accumulation in soils can have a profound and devastating effect on urban land developments, causing damage to building foundations, the breaking up of road pavements, and the corrosion of pipes and underground services. It can cause non salt-tolerant vegetation to die and, because of the greatly reduced ground cover, result in a dramatic lowering of the C-factor (Appendix A) with consequent increases in erosion hazards. Erosion hazard increases can also come about through high levels of salts in the soil changing soil structural characteristics, thereby preventing water infiltration and leading, in turn, to increased levels of runoff. Ecosystem health in streams downslope from saline lands can be adversely affected.
- (c) To identify lands that are potentially at risk from salinity, refer to Appendix C listing constraints to many soil landscapes identified in the Department of Infrastructure Planning and Natural Resources (DIPNR) 1:100 000 soil landscape mapping program. In addition, salinity potential maps are available from the DIPNR. These documents enable developers and councils to assess potential salinity for particular areas as a basis for the design and implementation of preventive and remedial actions.

2. Such circumstances can arise, for example, when trees are cleared on hillslopes with a marine-based lithology. Where this reduces transpiration and promotes rises in watertables, dryland salinity can be instigated.

3.2.14 Acid Sulfate Soils

- (a) Acid sulfate soils are a major environmental problem affecting lands on Australia's coast. They form when soils naturally containing iron sulfides are oxidized, forming sulfuric acid. Oxidation can occur when they are exposed to the air after having been dug up or drained. Large-scale drainage of coastal flood plains for flood mitigation, urban expansion and agriculture has exposed many areas of acid sulfate soils in NSW.
- (b) The high acid levels in water and the heavy metals consequently released from the exposed or drained soils cause significant environmental problems such as poor water quality and large fish kills, and economic costs to communities through degradation of roads and corrosion of pipes and footings.^[3] A major problem with acid sulfate soil is that they lower the pH to levels where aluminium becomes soluble (Al³⁺). While aluminium is the second most abundant element found naturally in soils, it is usually found in an insoluble form because soil pH is usually between 5.5 and 8.0. The soluble forms are toxic to most plant and animal life.
- (c) The occurrence of potential acid sulfate soils in New South Wales can be identified by reference to either the local *Acid Sulfate Soil Risk Map* prepared by and available from the DIPNR, and/or by reference to the local council's Acid Sulfate Soil Planning Map if developed and adopted by them as part of their Local Environmental Plan. Accompanying assessment guidelines provided by some councils help persons proposing activities likely to disturb potential acid sulfate soils.
- (d) The Acid Sulfate Soil Manual (Stone, *et al*, 1998) has been prepared by the Acid Sulfate Soil Management Advisory Committee (ASSMAC) providing comprehensive information on planning, assessment and management of acid sulfate soils. The Manual forms part of a "whole of government" approach to the management of acid sulfate soils in New South Wales. The manual is available from the DIPNR.
- (e) If acid sulfate soils are suspected of being present on the site an Acid Sulfate Soil Assessment should be carried out in accordance with the Acid Sulfate Soil Manual. These guidelines provide recommendations on the type and nature of the site investigations, the number of soil profiles required for assessment and the recommended laboratory analysis techniques and interpretation of results.
- (f) If acid sulfate soils are confirmed to be present and are to be disturbed by a proposed activity, an Acid Sulfate Soil Management Plan should be developed in accordance with the Acid Sulfate Soil Manual. The Acid Sulfate Soil Management Plan should outline all potential environmental impacts and include any potential

3. The solubilities of most elements (and their availability to living organisms) are greatly affected by pH. For example, aluminium becomes progressively more soluble at pH levels less than about 5.5 and, consequently, available for ingestion by living organisms. In its soluble form, aluminium is highly toxic.

3. Assessment of Constraints and Opportunities

impacts to the proposed development/infrastructure, and detail appropriate mitigation strategies.

- (g) The Acid Sulfate Soil Manual also provides information regarding the assessment and approval process and matters that should be included in an application for approval of works. The Manual also addresses matters that approval authorities should consider in making a decision in relation to works disturbing acid sulfate soils.

3.2.15 Soil Contamination/Toxicities/Pollution in Soils

- (a) Soil contamination can result from the actions associated with previous land uses where chemical concentrations have accumulated over time and, now, pose significant health risks to potential new occupiers and to the environment. These sites include cattle and banana dip sites, timber preservation processing sites, and chemical and petroleum product manufacturing and distribution sites.
- (b) The management of contaminated land is shared by the EPA, DIPNR and local councils. Under this framework, the EPA is empowered under Part 3 of the Contaminated Land Management Act (1997) to regulate contaminated sites that pose a significant risk of harm to human health or the environment. Other contaminated sites that do not pose significant risks to health or the environment and might be suitable for other land uses are managed by local councils through the land use planning process.
- (c) A series of guidelines prepared by the EPA set out considerations for those who encounter contamination and outline a process for proceeding where uncertainty exists. The EPA has now been incorporated into the Department of Environment and Conservation (DEC), and these guidelines are available from the DEC website in the publications section. The DEC website is at:

www.environment.nsw.gov.au

3.2.16 Mass movement

- (a) Two general types of mass movement are common: movement of colluvial material down steep slopes and movement of deep subsoils on slopes of various gradients.



Figure 3.1 Landslip in the Picton area of New South Wales.

- (b) The most common triggering agent for mass movement is water in the slip zone that reduces shear strength and increases slope loads. Studies suggest that most landslips occur in very wet periods following long dry spells, especially on hillslopes facing the rain bearing winds.^[4] Other common human induced landslip generating factors include:
- removal of material from the toe of a slope (especially on or below a former slip plane)
 - concentration of surface water or groundwater in slip-prone areas
 - removal of trees and other plants that might “pump” the watertable downwards.
- (c) The identification of existing and potential areas of mass movement, including landslip and earthflow, is an important part of the soil survey process. Areas with risk of failure have particular combinations of slope gradient, aspect, site drainage, soil type, geology and climatic features. Identification of these parameters enables erosion control planners to decide which areas should be avoided and are suitable for construction of soil and water management works.
- (d) Specialised geotechnical investigations should be undertaken if earthwork construction is proposed on landslip-prone lands.

4. Slip zones usually have very low shear strengths and often have plastic clays (e.g. CL or CH soils). When dry, the profile often cracks because of high shrink-swell ratios allowing water to quickly enter the slip zone.

3. Assessment of Constraints and Opportunities

3.3 Data Collection

3.3.1 Soil Data

- (a) Commonly in New South Wales, existing soils' information is adequate and a separate soil survey is not necessary, e.g. soil landscape information published by the DIPNR. In certain circumstances, more detailed levels of information might be required, such as, where sites are upslope from lands or receiving waters considered "sensitive", where a detailed land capability survey is required or where further site-specific information is required, e.g. suitability for on site domestic waste water disposal. In these circumstances, where appropriate guidelines for collection of site data exist, they should be followed. Such information can include:
- (i) site characteristics, e.g. topography (slope gradient and aspect), landform attributes (site morphology, slope morphology, landform elements), site condition (percentage ground cover, current condition, expected dry condition), lithology (rock outcrop, identification method, substrate material, lithology), hydrology (presence and depth of free water, permeability, profile drainage), erosion hazards, salinity, erosion, etc.;
 - (ii) soil and regolith characteristics, e.g. layer depth, colour, mottles, pH, layer boundary, soil water status, field texture, structure (grade, size, shape), ped coating, fabric, coarse fragments (type, amount, size), pans, segregations, consistence, lithology of parent material, etc.;
 - (iii) laboratory data, including; particle size analysis (<0.002 mm, 0.002 to 0.02 mm, 0.02 to 0.2 mm, 0.2 to 2.0 mm and 2 to 75 mm) (AS 1289 C6.2) dispersion percentage (Ritchie, 1963) and Emerson Aggregate Test (AS 1289 C8.1). Note: with strongly subplastic soils (generally, those stabilised by iron and red in colour, e.g. Krasnozems) particle size analysis for determination of erodibility should be undertaken without the use of dispersing agents, such as Calgon;
 - (iv) other information at the discretion of the soil scientist to support designation of constraints and in consideration of any land use requirement's table, e.g. electrical conductivity (Rayment and Higginson, 1992), USCS, etc.; and
 - (v) various derived data including Principal Profile Form (Northcote, 1979) and/or Australian Soil Classification (Isbell, 1996), profile permeability class, and other attributes chosen at the discretion of the soil scientist, e.g. soil wet strength, mass movement hazard, etc.
- (b) A separate soil survey might be necessary where information detailed in (a) above does not exist. In this case:
- (i) Examine soil profiles to a depth of at least 1.5 metres or maximum depth of proposed disturbance and/or to bedrock; and

-
- (ii) Use the New South Wales Soil Data Cards available from SALIS for recording field data and enter the completed cards into the NSW Soil and Land Information System (SALIS). Field methods and terminology are given in McDonald *et al.* (1990) and Abraham & Abraham (1996).
- (iii) Specify sampling intensity in consultation with the project manager. Nevertheless, as a general guide on sites larger than five hectares:
- Record at least five site observations and one detailed soil profile description (including completion of Soil Data Cards) for each landform element within each lithology or regolith unit, or at least five detailed soil profile descriptions (and Soil Data Cards) for each unique soil unit identified, whichever is the more intensive
 - Sampling intensity should also reflect mapping scale with recommended densities in the range of 10 to 20 detailed soil profile descriptions per hectare at 1:1,000 scale, 0.5 to 1 per hectare at 1:5,000 scale, and 1 to 2 per 10 hectares at 1:10,000 scale. (If sampling sites are evenly spread, they will be generally no more than 30 millimetres apart on the map)
 - About 20 percent of the detailed soil profile descriptions should also be subject to laboratory analysis and this should include at least one analysis of each major soil horizon in each unique soil unit identified.
- (iv) Where ecologically sensitive areas are likely to be affected, a detailed land capability assessment can be necessary. Alternatively, other more site-specific issues (e.g. on site domestic waste water disposal) must be considered, in which case the minimum sampling intensity described above might not be sufficient. In this case, sampling intensity should be based on the appropriate specific issue guideline, or otherwise determined in consultation with the project manager. Sampling intensity is likely to be less on smaller sites, particularly those smaller than 1 hectare.

3.3.2 Other Data

Separate map(s) of the following data are not usually required. Nevertheless, the information should be available for presentation, if requested for example, as part of a land capability assessment (Section 3.4) and at a scale of 1:10,000 or larger.

- (i) lithology or regolith features if available from existing data;
- (ii) slope – classes chosen at the discretion of the soil scientist, but with a minimum of three between zero and 30 percent gradient and meeting Soil Loss Class requirements (Section 4.4.2(b));
- (iii) landform element (McDonald, *et al.*, 1990) – classes chosen from Table 3.1;
- (iv) soil type – soil units chosen at the discretion of a soil scientist;
- (v) where appropriate, ground water resources/aquifer recharge areas; and

3. Assessment of Constraints and Opportunities

Table 3.1 Landform Elements (Abraham and Abraham, 1996)

Site process	Site morphology				
	Crest, hillock or ridge	Slope	Flat	Open depression	Closed depression
residual denudational	hillcrest plateau		plain	drainage depression	
	cliff cone tor	bench cliff/scarp hillslope landslip	bench scald	alcove drainage depression gully	cirque crater sink hole/doline
		footslope pediment scree talus		drainage depression gully	maar
alluvial, lucustrine or littoral	bar beach ridge levee prior stream scroll	bank beach fan	backplain channel bench flood-out plain rock flat rock platform scald tidal flat valley flat	drainage depression estuary streambed stream channel swale tidal creek	lagoon lake oxbow pan/playa sink hole/doline swamp
	dune foredune lunette		scald plain	blowout swale	blowout swale
disturbed	dam embankment mound	berm cut face embankment	cut-over surface fill top	trench	pit

-
- (vi) other appropriate attributes that might affect locations of stockpiles, fill zones, etc. especially from an ESD perspective.

3.3.3 Some Data Sources

Various sources of soils, climatic and geomorphic data that might be applicable to particular lands in New South Wales include:

- (i) Appendix C of this manual;
- (ii) the local council;
- (iii) various handbooks, manuals and reports published by the DIPNR, e.g.
 - the soil landscapes of some of the 1:100,000 and 1:250,000 topographic sheets for New South Wales – contact:
Information Centre
DIPNR
GPO Box 39
SYDNEY NSW 2001 – phone: (02) 9228 6415
 - detailed soil profile information for various places throughout New South Wales – contact:
The Manager, SALIS
DIPNR
PO Box 3720
PARRAMATTA NSW 2124 – phone: (02) 9895 6204.
<http://www.dipnr.nsw.gov.au/care/soil/salis/>
Data is free for regular contributors.

3.4 Data Application

- (a) More often than not, the data collected through application of Sections 3.1 to 3.3 is not presented formally in separate documents. Nevertheless, the data underpins the choice of management practices described in any *Soil and Water Management Plan* (Section 2.3.2).
 - (i) At some larger (usually “green field”) sites, the local consent authority might require the above information to be presented as part of a land capability study. Apart from helping determine various planning issues, site information collected by such studies can also help confirm the suitability of lands for the application of various BMPs. Further guidance is provided in this regard in the *Managing Urban Stormwater: Urban Design* document.

3. Assessment of Constraints and Opportunities

Table 3.2

Class	Description
1	The particular land use is acceptable, with any land, soil or water constraints occurring only at a low degree. Standard design, construction and management techniques can be used
2	The particular land use is acceptable. However, one or more land, soil or water constraints exist at a moderate (but not high) degree that are likely to require specialised management and/or construction techniques
3	The particular land use might not be acceptable. One or more land, soil or water constraints occur at a high degree that should be the subject of further detailed investigations into the appropriate geotechnical/engineering, and/or soil/water conservation matter
X	This special class includes areas with a very high variability of land, soil or water constraints that are unable to be delineated adequately at the scale of mapping and/or where further detailed site investigations are necessary

The Land Capability Classes

- (b) Present maps of capability separately for each form of intended land use that clearly identify:
 - (i) the capability classes (Table 3.2); and
 - (ii) other appropriate constraining properties relating to the site. A possible listing of some relevant climatic, geomorphic and pedologic constraints that might apply, with the degree of each constraint categorised.
- (c) Label each similar land unit in the mapping process with a mapping code. For consistence, it is recommended that the first code in each homogenous mapping unit on the:
 - (i) land unit map/overlay be the geological code, followed in order by codes for slope, landform element and soil type
 - (ii) land capability map/overlay/table should be the land capability class, followed by codes representing the constraints. Show these latter symbols only where the degree of constraint is high (listed first and in uppercase) or moderate (listed second and in lowercase). Symbols do not need to be presented where the degree of constraint is low.
- (d) Provide a plain-English report with various maps, ensuring the main body is presented in a format that can be understood by people who do not necessarily have a scientific background, and include:

-
- (i) an outline of the study aims;
 - (ii) a synopsis of the physical attributes of the site, including data to support the various maps;
 - (iii) a description of any landscape, water and soil constraints, including:
 - identification of lands best/least suited to the proposed development
 - alternatives/options available
 - location of likely buffer areas and drainage reserves;
 - (iv) address suggestions about how those constraints, including possible options might be incorporated into a Soil and Water Management Plan (Section 3), for:
 - staging of works
 - mitigation/ control of onsite erosion
 - movement of water onto, through and off the site
 - mitigation/ control of flooding/pollution to downslope lands and waterways
 - rehabilitation/maintenance of lands; and
 - (v) recommendations that ensure sustainable development and prevent unacceptable degradation of the soil and water resources, and the aesthetic and other environmental resources.
- (e) The appendixes should contain:
- (i) detailed soils information including copies of the Soil Data System's "Plain-English Reports", and complete laboratory results;
 - (ii) a brief description of any laboratory techniques used; and
 - (iii) rainfall intensity frequency duration (IFD) tables.



Chapter 4

EROSION CONTROL: MANAGEMENT OF SOILS

4. Erosion Control: Management of Soils

In this chapter, Section 4.1, Section 4.2 and Section 4.3 apply to all works where more than 250 square metres of land will be disturbed and requires the preparation of either an ESCP or a more detailed SWMP (Chapter 2). Section 4.4 applies only to sites where 2,500 square metres of land or more will be disturbed and a SWMP is required.

4.1 Introduction

The risk of erosion at land development sites is usually proportional to how much soil is exposed to erosive elements through loss of vegetative cover. Vegetation:

- (i) binds the soil particles together and reduces the erosive effects of rain splash impact, surface water flow and wind;
- (ii) can decrease wind and water velocity on the ground surface;
- (iii) decreases the quantity of surface water runoff through an increase in interception water, depression storage and infiltration (figure 4.1);^[1] and
- (iv) helps retain sediment and nutrients on site.

The combined effect of these qualities of vegetation can result in a reduction in potential erosion to less than 1 percent of that with no vegetative cover (i.e. C-factors of less than 0.01 (Appendix A)). Other ground covers and soil surface protective measures can also reduce erosion, but to varying degrees of effectiveness (Section 7.4).

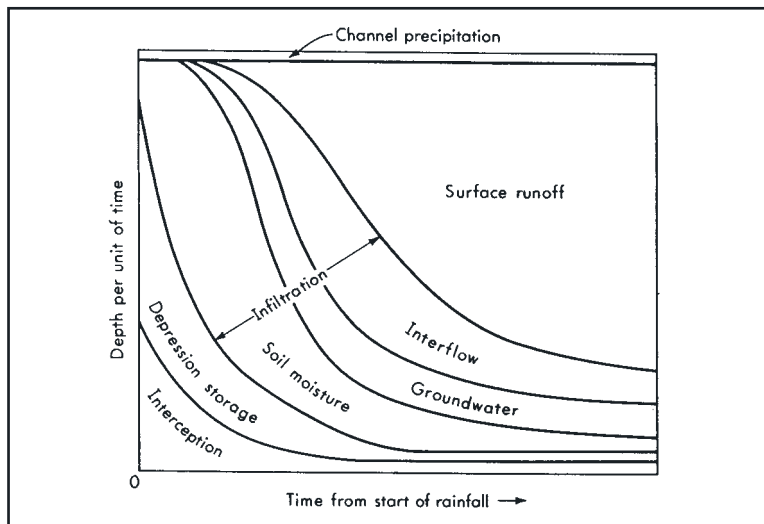


Figure 4.1 Division of storm rainfall into its component parts assuming constant precipitation (Morisawa, 1968)

1. Note:

- soil structural decline and consequent reduction in soil permeability commonly results from loss of vegetative cover
- increased infiltration does not necessarily result in rises in the watertable where corresponding increases in evapotranspiration from plant growth occurs
- to avoid soil salinisation, the watertable needs to be closely monitored for saline content in areas used to increase infiltration or surface runoff.

4.2 Planning Considerations

- (a) Where practicable, schedule the construction program so that the time from commencement of land disturbance activities to rehabilitation is less than six months. Restrict land disturbance to areas of workable size. Lands next to waterways should remain undisturbed for as long as possible and at least until the installation of culverts.
- (b) Where possible, do not extend land disturbance activities beyond five (preferably two) metres from the edge of any essential construction activity other than in access areas (Table 4.1). These zones of restricted access might require clear identification with barrier mesh, sediment fencing, or other appropriate materials.

Table 4.1 Works limitations

Land use	Limitation	Comments
Construction areas	Disturbance to be no further than 5 (preferably 2) metres from the edge of any essential construction activity as shown on the engineering plans	All site workers should clearly recognise these zones that, where appropriate, are identified with barrier mesh (upslope) and sediment fencing (downslope), or similar materials
Access areas	Limited to a maximum width of 10 metres	The site manager should determine and mark the location of these zones on site. They can vary in position to best converse the existing vegetation and protect downstream areas while being considerate of the needs of efficient works' activities. All site workers should clearly recognise their boundaries which, where appropriate, are marked with barrier mesh, sediment fencing, or similar materials
Remaining lands	Entry prohibited except for essential thinning of plant growth	All site workers clearly recognise this land by marking boundary with barrier fence, etc.

4. Erosion Control: Management of Soils

4.3 Handling Soils

4.3.1 General erosion control guidelines

- (a) Where possible and where more than 1,000 square metres of land are to be disturbed, ensure that slope lengths do not exceed 80 metres immediately before forecast rainfall or during shutdown periods. Any temporary diversions should outlet to stable discharge areas. On highly erodible lands, constructing earth banks (catch drains) at intervals of less than 80 metres might be necessary to reduce erosion hazards further.
- (b) Where necessary, shorten steeper slopes through construction of mid-slope berms (figure 4.2) or other water diversion structures (Section 5.4.4).

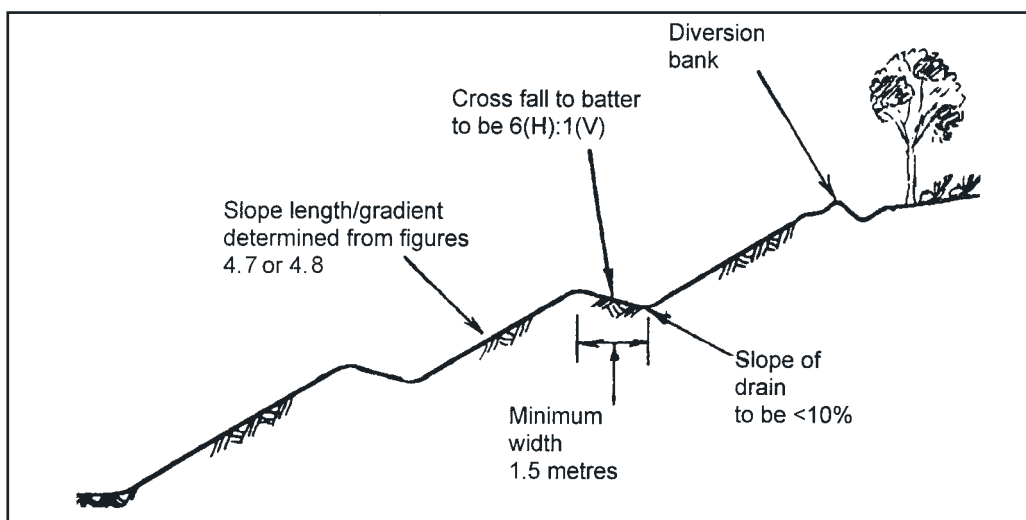


Figure 4.2 Construction of a berm drain.

4.3.2 Topsoil handling procedures

- (a) Ideally, handle topsoil only when it is moist (not wet or dry) to avoid decline of soil structure.^[2]
- (b) Undertake stripping and stockpiling of topsoil immediately before starting bulk earthworks. Before stripping:
 - (i) Identify and mark out those areas of vegetation or trees that are to be retained on the site. Commence clearing of trees and shrubs that are within the areas

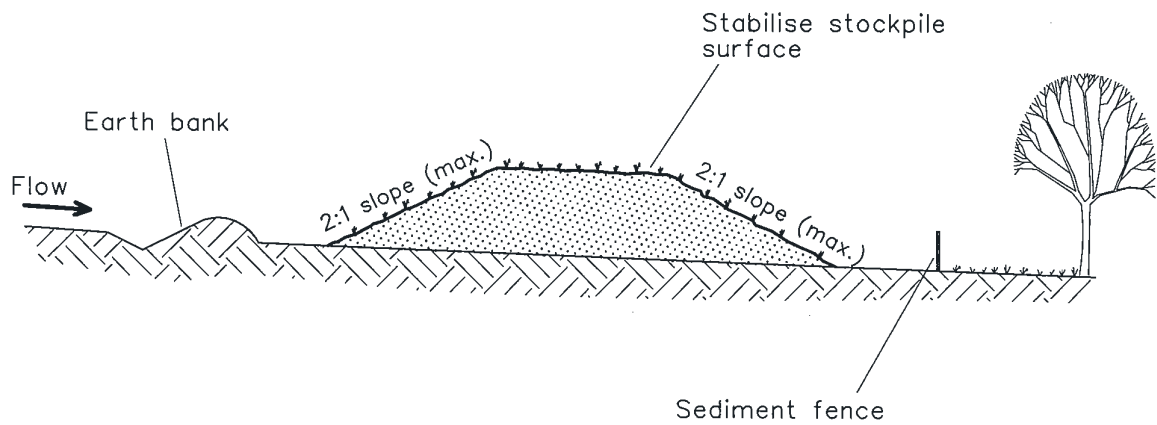
2. Many types of topsoil are liable to be pulverised if they are too dry when handled and/or pug (set very hard in large clods when dry) if they are too wet when handled.

-
- designated for berm drains, roadworks, interallotment drainage, etc. and stockpile the cut vegetative materials for mulching on site. Separate other debris including fence posts, wire, rocks, etc.; or alternatively
- (ii) Slash or graze the site where vegetative growth is dense.^[3]
 - (c) Where necessary, thin plant growth outside the construction zone by hand or rubber-tyred implement. Retain small branches, leaf litter and other residues as mulch.
 - (d) Take particular care when handling noxious plants that viable parts are not transported offsite by machines.
 - (e) See Section 5.3.4 regarding the construction of temporary culverts or causeways that might be necessary to cross drainage reserves during the stripping or stockpiling process.
 - (f) Strip topsoil usually to a depth of 100 to 150 millimetres.
 - (g) Where maintaining seed viability is desirable, ensure stockpiles of topsoil and leaf litter from remnant native bushland areas are no greater than 2 metres deep and kept weed-free. Structural decline in topsoil is likely in deeper stockpiles.
 - (h) Ensure stockpiles (Standard Drawing 4-1) are:
 - (i) constructed on the contour at least 2 (preferably 5) metres from hazard areas, particularly likely areas of concentrated water flows, e.g. waterways, roads, slopes steeper than 10 percent, etc.;
 - (ii) stabilised if they are to be in place for more than 10 days (Section 7.1.2 (d));
 - (iii) protected from run-on water by installing water diversion structures upslope (Section 5.4.4); and
 - (iv) formed with sediment filters placed immediately downslope to protect other lands and waterways from pollution (Section 6.3.7 (e)).
 - (i) Use topsoil on all lands to be rehabilitated by vegetative means.
 - (j) Normally, rehabilitate constructed slopes steeper than 2(H):1(V) by non vegetative means such as riprap.
 - (k) Before spreading topsoil, scarify the ground surface along the line of the contour to break any compacted and/or smooth materials^[4] and enable key bonding of the materials to one another.^[5] Do not apply topsoil to batters where keying is not possible (Standard Drawing SD 4-2).

3. Consider stockpiling some or all of any slashed materials for later redistribution to the site as mulch (Section 7.4.1).

4. On constructed slopes less than about 3(H):1(V), scarify with tined implements or excavators to depths of 50 to 100 mm. On gradients steeper than about 3(H):1(V), chain or harrow to break any surface seals and fill any minor rills; alternatively, surfaces can be track-walked (using a crawler tractor driven up and down the slope leaving tread imprints parallel to the contour) (figure 4.3).

5. Keying binds topsoil and substrate layers and, so, mitigates the possibility of sheet erosion and/or creep or slump of topsoil; and enhances water infiltration to the upper subsoil layers, increasing moisture storage within the root zone.

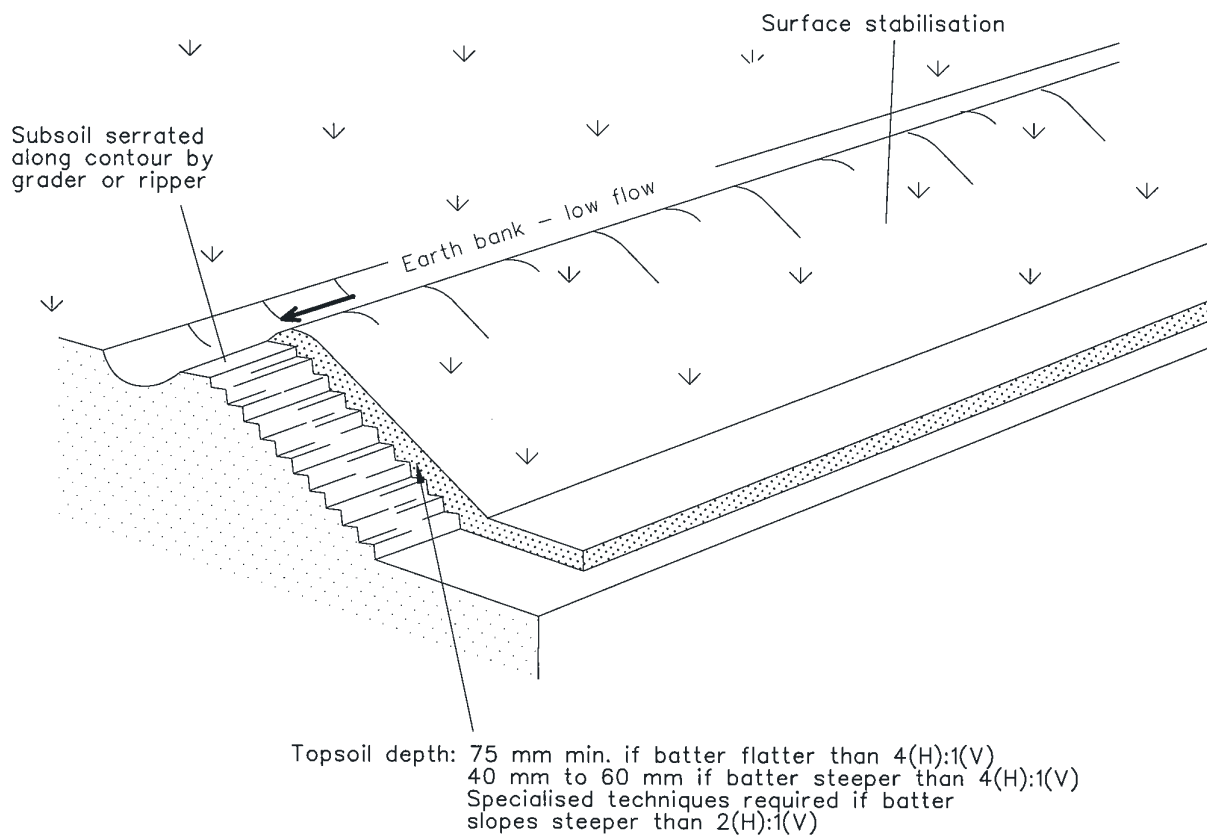


Construction Notes

1. Place stockpiles more than 2 (preferably 5) metres from existing vegetation, concentrated water flow, roads and hazard areas.
2. Construct on the contour as low, flat, elongated mounds.
3. Where there is sufficient area, topsoil stockpiles shall be less than 2 metres in height.
4. Where they are to be in place for more than 10 days, stabilise following the approved ESCP or SWMP to reduce the C-factor to less than 0.10.
5. Construct earth banks (Standard Drawing 5-5) on the upslope side to divert water around stockpiles and sediment fences (Standard Drawing 6-8) 1 to 2 metres downslope.

STOCKPILES

SD 4-1



Construction Notes

1. Scarify the ground surface along the line of the contour to a depth of 50 mm to 100 mm to break up any hardsetting surfaces and to provide a good bond between the respread material and subsoil.
2. Add soil ameliorants as required by the ESCP or SWMP.
3. Rip to a depth of 300 mm if compacted layers occur.
4. Where possible, replace topsoil to a depth of 40 to 60 mm on lands where the slope exceeds 4(H):1(V) and to at least 75 mm on lower gradients.

4. Erosion Control: Management of Soils

- (l) Apply topsoil to a depth of:
 - (i) about 40 to 60 mm on lands where the slope exceeds 4(H):1(V);^[6] and
 - (ii) at least 75 mm on sites where the slope is less than 4(H):1(V).
- (m) On completion of the respreading process, leave disturbed lands with a scarified surface^[7] to inhibit soil erosion, encourage water infiltration and help with keying topsoil later (figure 4.3).
- (n) Respread mulched vegetative material to provide soil stability on bare areas and particularly on those areas where landscape tree planting or bushland is to be established after works are complete.
- (o) Select plant species that are consistent with the existing soil conditions at the site. Where practical, ensure the plants are consistent with any indigenous vegetation.
- (p) Follow the stabilisation recommendations in Chapter 7.



Figure 4.3(a)
A track-walked slope
(see footnote 4)

6. Topsoil creep/slump is likely with greater topsoil depths, especially where keying is not satisfactory.
7. The practice (especially on batters) of leaving surfaces in a glazed condition with hard, smooth surfaces is not acceptable for several reasons, e.g. topsoils can slump, infiltration can be retarded, etc.



Figure 4.3(b) A track-walked slope (see footnote 4)



Figure 4.4 Phasing of rehabilitation is clearly evident on this batter

4. Erosion Control: Management of Soils



Figure 4.5 Recently rehabilitated lands at an urban subdivision near Sydney. Note the barrier mesh and sediment fencing still in position.

4.4 Special Considerations for SWMPs

4.4.1 Assessment of Erosion Hazard

- (a) A simple procedure is provided to identify those sites of low erosion hazard, where the normal suite of erosion control measures, defined in earlier sections of this Chapter, is considered adequate.
- (b) The potential erosion hazard associated with a specific site can be simply determined from figure 4.6, based on:
 - the R-factor (rainfall erosivity) that relates to your site location, determined from the maps provided in Appendix B; and
 - the typical upper slope gradient (measured in percent) of the site landform.
- (i) Sites below the A-line on figure 4.6 have low potential erosion hazards and the standard erosion control measures defined in earlier sections of this Chapter are considered adequate. Planners of such sites need not undertake the tasks outlined in the remainder of Section 4.4^[8].
- (ii) Sites above the A-line have high potential erosion hazards and designers should apply the guidelines in Section 4.4.2, below.

8. Figure 4.6 has been derived assuming a typical maximum K-factor of 0.05, slope length of 80 metres, P-factor of 1.3 and C-factor of 1.0.

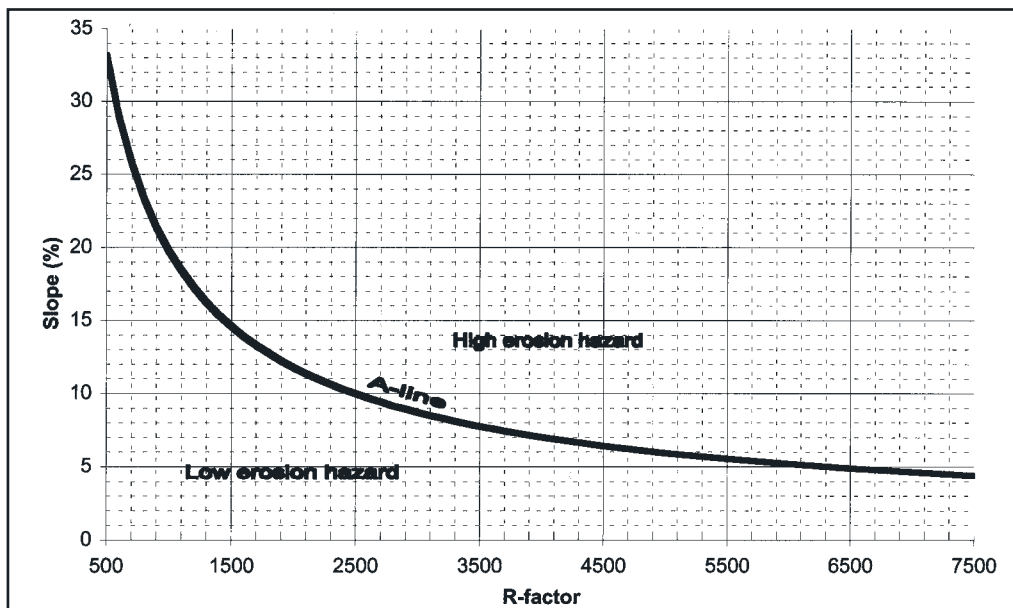


Figure 4.6 Assessment of potential erosion hazard

4.4.2 Management of Sites of High Erosion Hazard

Important Note: If you are not thoroughly familiar with the information on the Revised Universal Soil Loss Equation (RUSLE) presented at Appendix A, read it now.

- (a) On constructed slopes ensure that slope length^[9] and gradient relationships do not exceed those shown in figures 4.7 and 4.8.^[10] Note that rehabilitating steeper slopes (>2.5(H): 1(V)) by vegetative means can be difficult, especially where the soils are highly permeable, irrigation is not available and on sites with northerly or westerly aspects. The problem is greatest in the parts of New South Wales that are prone to extended periods where evaporation exceeds rainfall (i.e. nearly all areas except the North Coast and Snowy Mountains regions).
- (b) Calculate the erosion hazard on all lands to be disturbed according to the Soil Loss Class (Table 4.2).^[11] These classes should be based on local R, K and LS-factors with 80 metre slopes. Typical of most construction areas, also assume P-factors of

9. Here, slope length includes any batters and all upslope lands to a subcatchment boundary, either natural (e.g. crests) or built (e.g. roads or catch drains).

10. The graphs in figures 4.7 and 4.8 are based on $LS = 750/1.3(R \times K)$.

11. The Soil Loss Class has been used traditionally to compare apples with apples in relation to soil erosion hazard. Increasing the R-factor in the calculation of the Soil Loss Class by, say, factors of 1.4 and 2.3 where the receiving waters are highly or extremely sensitive, respectively, might be desirable. Highly and extremely sensitive receiving waters might include those requiring significant or comprehensive protection in Healthy Rivers Commission (2002), or those mapped as Classes P and S in SPCC (1980). Any increases should be considerate of the R-factor AEP (Appendix A), where the 20 percent AEP is suggested for highly sensitive waters and the 5 percent AEP for extremely sensitive waters.

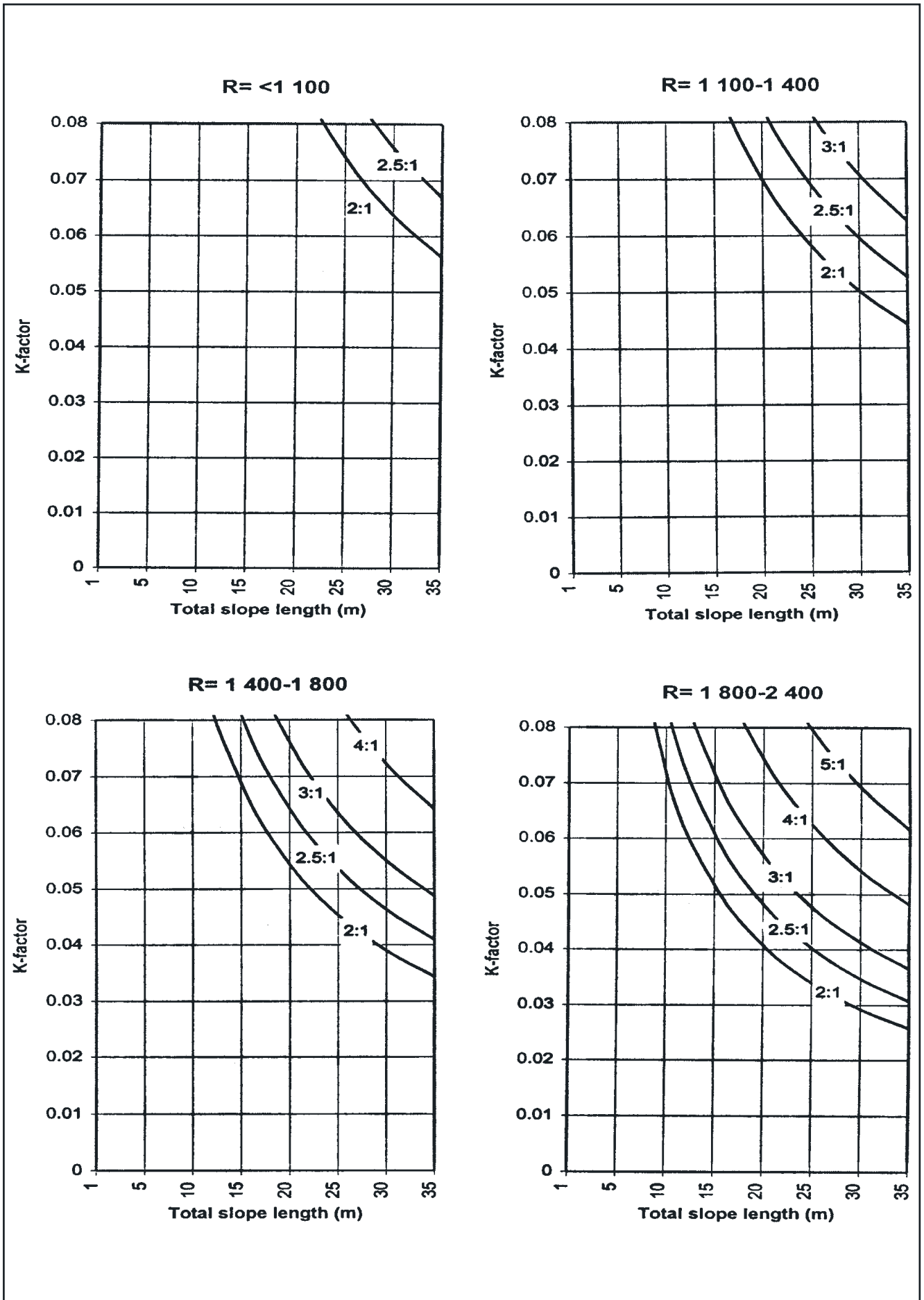


Figure 4.7 Maximum batter gradient (H:V) where the R-factor is 1,100, 1,400, 1,800 and 2,400 (adapted from Morse and Rosewell, 1993) (Appendix A)

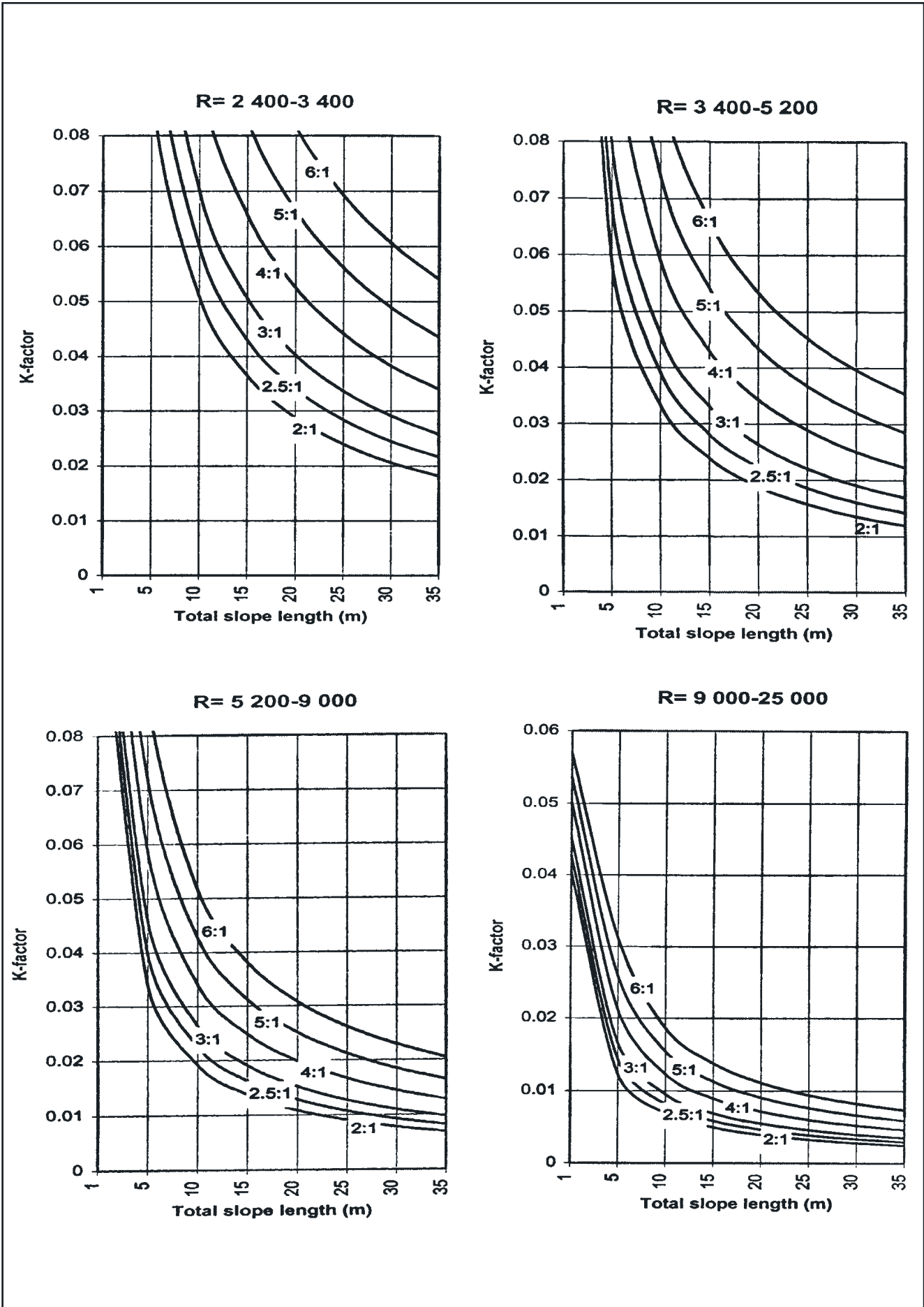


Figure 4.8 Maximum batter gradient (H:V) where the R-factor is 3,400, 5,200, 9,000 and 25,000 (adapted from Morse and Rosewell, 1993) (Appendix A)

4. Erosion Control: Management of Soils

Table 4.2 The Soil Loss Classes (adapted from Morse and Rosewell, 1996)

Soil Loss Class	Calculated soil loss (tonnes/ha/yr)	Erosion hazard
1	0 to 150	very low
2	151 to 225	low
3	226 to 350	low-moderate
4	351 to 500	moderate
5	501 to 750	high
6	751 to 1,500	very high
7	>1,500	extremely high

1.3 (i.e. the soils are hard and compact) and C-factors of 1.0 (i.e. no vegetative cover, probably being removed with a scraper). Planners can apply different slope lengths, P or C-factors if these are properly justified. Application of shorter slope lengths, for example, can put a site into a lower Soil Loss Class. However, the management of these variations should be clearly explained in any plans for erosion control (Chapter 2).

- (c) Having identified the applicable Soil Loss Class, ideally schedule activities on highly sensitive lands to periods when rainfall erosivity is low. Highly sensitive lands occur:
- (i) Always on Soil Loss Class 7 lands; and
 - (ii) At certain times of the year:
 - on Soil Loss Classes 5 or 6 lands in all rainfall zones (figure 4.8)
 - on Soil Loss Class 4 lands in Rainfall Zones 5 and 11.

Here, waterfront lands (Appendix I) should be regarded as Soil Loss Class 6 always.

Table 4.3 identifies those times of the year that do not contribute significantly to the rainfall erosivity (Appendix A) for different rainfall zones (figure 4.9). It shows those lands where land disturbance activities can be undertaken only with the application of special measures (marked "yes") and those where special measures are not

required (marked "no"). Of course, this assumes that the regular suite of BMPs is installed as outlined elsewhere in these guidelines).^[12]

- (d) Where scheduling activities on highly sensitive lands to periods when rainfall erosivity is low is not possible or is impractical, ideally ensure that any disturbed lands have C-factors higher than 0.1 only when the 3-day forecast suggests that rain is unlikely. In this case, management regimes should be established that facilitate stabilisation within 24 hours should the forecast prove incorrect.^[13]
- (e) The kinds of other special erosion control measures that might be invoked in any erosion control plans are usually site specific and beyond the scope of these guidelines.

12. Efforts should be made to keep the calculated soil loss less than 50 tonnes per hectare in any one half month, i.e. the product of percentage average annual *EI* for any particular half month (Rosewell and Turner, 1992) and calculated average annual soil loss should be less than 50 tonnes. So, Table 4.4 shows that:

- Special measures are required on Soil Loss Class 3 lands when more than 14 percent of the average annual *EI* normally occurs in a half month
- Special measures are required on Soil Loss Class 4 lands when more than 10 percent of the average annual *EI* normally occurs in a half month
- Special measures are required on Soil Loss Class 5 lands when more than 6 percent of the average annual *EI* normally occurs in a half month
- Special measures are required on Soil Loss Class 6 lands when more than 3 percent of the average annual *EI* normally occurs in a half month
- Special measures are always required on Soil Loss Class 7 lands.

13. C-factors of 0.1 can be achieved in various ways as shown at Appendix A, note especially figure A5, Table A3 and Table A4. For example, figure A5 shows that a C-factor of 0.1 can be achieved with a 60 percent grass cover where, previously, the soils were stripped or deeply cultivated; alternately, Table A3 shows it can be achieved temporarily by application of a hydraulic soil stabiliser.

Table 4.3 Lands where special erosion control measures apply

Zone	Soil Loss Class	Jan	Feb	Mar	Apr	May	Jun	Jul	Aug	Sep	Oct	Nov	Dec
1	1-4	No	No	No	No	No	No	No	No	No	No	No	No
	5	No	Yes	Yes	Yes	Yes	No	No	No	No	No	No	No
	7	Yes	Yes	Yes	Yes	Yes	Yes	Yes	Yes	Yes	Yes	Yes	Yes
2	1-4	No	No	No	No	No	No	No	No	No	No	No	No
	5	Yes	Yes	Yes	No	No	No	No	No	No	No	No	No
	7	Yes	Yes	Yes	Yes	Yes	Yes	Yes	Yes	Yes	Yes	Yes	Yes
3	1-4	No	No	No	No	No	No	No	No	No	No	No	No
	5	No	Yes	Yes	Yes	Yes	No	No	No	No	No	No	No
	7	Yes	Yes	Yes	Yes	Yes	Yes	Yes	Yes	Yes	Yes	Yes	Yes
4	1-4	No	No	No	No	No	No	No	No	No	No	No	No
	5	No	Yes	Yes	Yes	Yes	No	No	No	No	No	No	No
	7	Yes	Yes	Yes	Yes	Yes	Yes	Yes	Yes	Yes	Yes	Yes	Yes
5	1-3	No	No	No	No	No	No	No	No	No	No	No	No
	4	No	Yes	Yes	Yes	Yes	No	No	No	No	No	No	No
	7	Yes	Yes	Yes	Yes	Yes	Yes	Yes	Yes	Yes	Yes	Yes	Yes
6	1-4	No	No	No	No	No	No	No	No	No	No	No	No
	5	No	Yes	Yes	Yes	Yes	No	No	No	No	No	No	No
	7	Yes	Yes	Yes	Yes	Yes	Yes	Yes	Yes	Yes	Yes	Yes	Yes
7	1-4	No	No	No	No	No	No	No	No	No	No	No	No
	5	No	Yes	Yes	Yes	Yes	No	No	No	No	No	No	No
	7	Yes	Yes	Yes	Yes	Yes	Yes	Yes	Yes	Yes	Yes	Yes	Yes
8	1-4	No	No	No	No	No	No	No	No	No	No	No	No
	5	No	Yes	Yes	Yes	Yes	No	No	No	No	No	No	No
	7	Yes	Yes	Yes	Yes	Yes	Yes	Yes	Yes	Yes	Yes	Yes	Yes
9	1-4	No	No	No	No	No	No	No	No	No	No	No	No
	5	No	Yes	Yes	Yes	Yes	No	No	No	No	No	No	No
	7	Yes	Yes	Yes	Yes	Yes	Yes	Yes	Yes	Yes	Yes	Yes	Yes
10	1-4	No	No	No	No	No	No	No	No	No	No	No	No
	5	No	Yes	Yes	Yes	Yes	No	No	No	No	No	No	No
	7	Yes	Yes	Yes	Yes	Yes	Yes	Yes	Yes	Yes	Yes	Yes	Yes
11	1-3	No	No	No	No	No	No	No	No	No	No	No	No
	4	No	Yes	Yes	Yes	Yes	No	No	No	No	No	No	No
	7	Yes	Yes	Yes	Yes	Yes	Yes	Yes	Yes	Yes	Yes	Yes	Yes
12	1-4	No	No	No	No	No	No	No	No	No	No	No	No
	5	No	Yes	Yes	Yes	Yes	No	No	No	No	No	No	No
	7	Yes	Yes	Yes	Yes	Yes	Yes	Yes	Yes	Yes	Yes	Yes	Yes

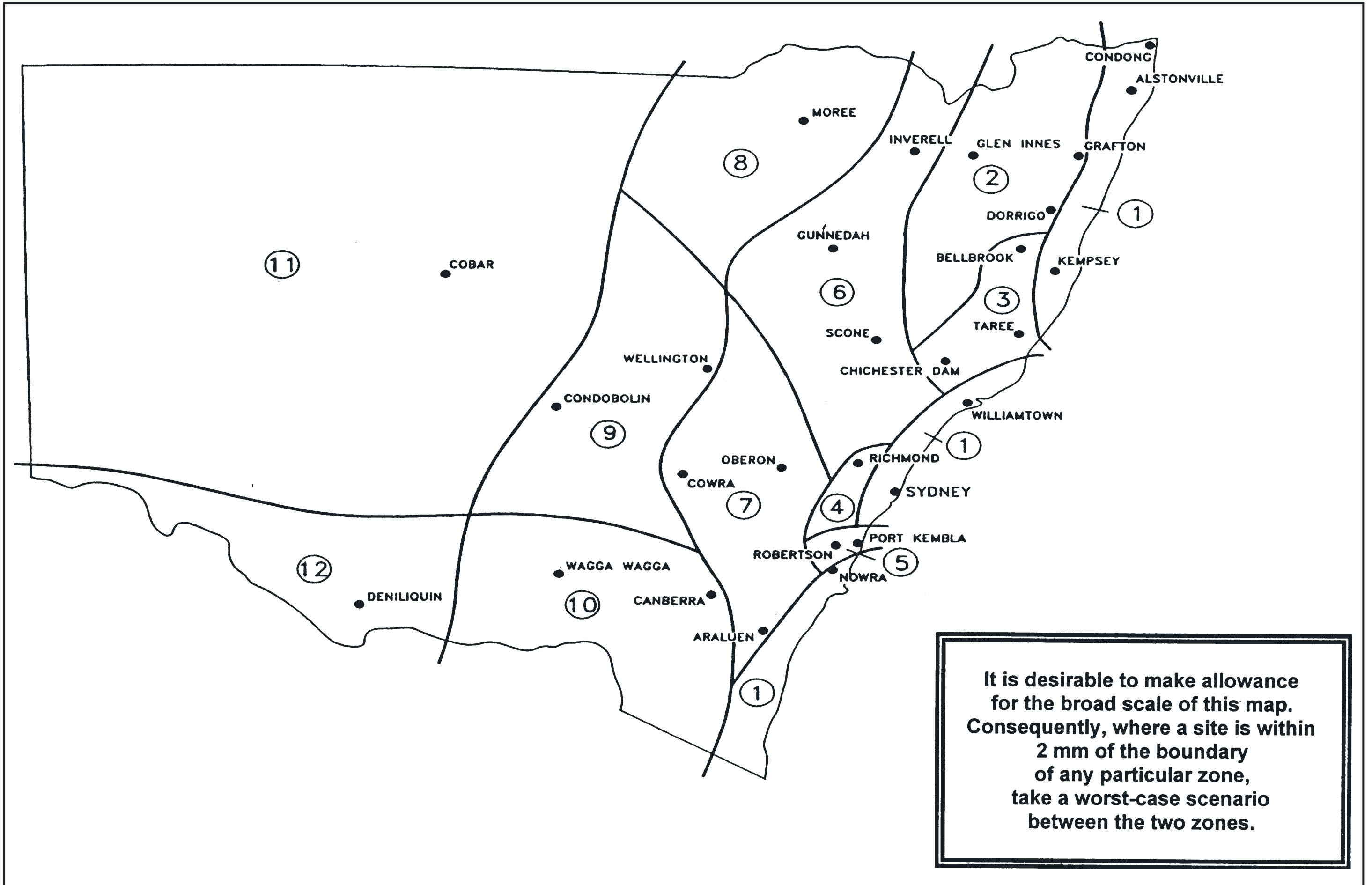


Figure 4.9 Rainfall distribution zones in New South Wales (Rosewell and Turner, 1992)



Chapter 5

EROSION CONTROL: MANAGEMENT OF WATER

5. Erosion Control: Management of Water

This chapter discusses erosion control through management of surface water flows. Being the pre-eminent consideration, works in and within core riparian zone are discussed first. Then, issues relating to sheet water flows and concentrated water flows outside the trunk drainage are addressed.

5.1 Introduction

- (a) This chapter considers the selection, design and operation of water control structures that might be built during a development or land disturbance stage, including permanent drainage systems. Additional aspects are found in other texts (Chapter 10), including:
- *Managing Urban Stormwater: Council Handbook* (DEC, in prep.)
 - *Managing Urban Stormwater: Treatment Techniques* (DEC – 2nd edition, in prep.)
 - *Managing Urban Stormwater: Urban Design* (DEC, in prep.)
 - *Constructed Wetlands Manual* (DLWC, 1988)
 - *Australian Rainfall and Runoff (AR&R)* (Pilgrim, 1998)
 - *Australian Rainfall Quality (draft)* (IEA, 2003).
- (b) The process of land development often results in substantial modification to both the hydrological and topographical characteristics of a catchment. Note that:
- (i) The hydrological characteristics usually undergo most change and result from:
- an increase in impervious surfaces, e.g., roofs and paved areas
 - concentration of water through artificial drainage works
 - alteration to the natural drainage pattern; and
- (ii) The effect of these hydrological changes varies, but unless suitable control measures are in place, usually results in:
- a reduction in time of concentration
 - a reduction in the duration of floods
 - an increase in erosion hazards
 - a considerable increase in the magnitude and frequency of peak flows.
- (c) Erosion hazards and consequent risks of sediment pollution usually reach their highest levels during the land disturbance phase and the effects of soil and water management on disturbed sites are critical.
- (d) Naturally, all works must comply with the various Acts (Appendix K), including:
- Water Act, 1912
 - Soil Conservation Act, 1938
 - Rivers and Foreshores Improvement Act (1948) (note Part 3A)
 - Dam Safety Act, 1978
 - Fisheries Management Act, 1994
 - Protection of the Environment Operations Act, 1997
 - Water Management Act, 2000.

5.2 Classification of Waterbodies Based on Objectives for Riparian Land

Riparian lands form the transition between terrestrial and aquatic environments.^[1] As riparian environments are very diverse, defining a standard width for riparian lands is difficult. Nevertheless, three broad categories for riparian land are identified by the Department of Infrastructure, Planning and Natural Resources to reflect the relative importance of watercourses. Different management regimes apply to each of these categories (Table 5.1):

(a) Category 1 – environmental corridor^[2]

Maximise the protection of terrestrial and aquatic habitats to:

- provide a continuous corridor for the movement of flora and fauna
- provide extensive habitats (and connectivity between habitat nodes) for terrestrial and aquatic fauna
- maintain the viability of native riparian vegetation
- manage edge effects at the riparian/urban interface
- provide bank stability
- protect water quality.

This is achieved by:

- (i) where applicable, providing a continuous riparian corridor that links stands of remnant vegetation;
- (ii) providing a “core riparian zone” (CRZ) with a minimum width of 40 metre from the top of the bank;
- (iii) providing sufficient (additional) riparian corridor width based on geomorphological and environmental considerations;
- (iv) providing a suitable environmental protection zoning to the riparian land that recognises its environmental significance;
- (v) as far as practicable, restoring/rehabilitating the riparian zone by returning the vegetation, geomorphic structure, hydrology and water quality to the original (pre European) condition;
- (vi) ensuring vegetation in the CRZ is at a density that would occur naturally (but see Section 5.3);

1. Riparian lands are those lands immediately next to and along or around waterbodies. They act as buffers and/or filters between the waterbodies and lands nearby. Also, they:

- help with maintenance or improvement of water quality through stabilising banks
- are important wildlife corridors that maintain biodiversity
- improve aesthetic values, e.g. open space and the visual break up of lands.

2. Also note the importance of corridor connections between adjoining watercourses.

5. Erosion Control: Management of Water

Table 5.1 Summary of Riparian Management Objectives

Minimum environmental objectives for riparian land	Category 1: Environmental corridor	Category 2: Terrestrial and aquatic habitat	Category 3: Bank stability and water quality
Delineate riparian zone on a map and zone appropriately for environmental protection	Yes	Yes	Not required
Provide a minimum core riparian zone width	40m from top of bank	20m from top of bank	No minimum – pipes last resort
Provide additional width to counter edge effects on the urban interface	10m	10m	Generally not required
Provide continuity for movement of terrestrial and aquatic habitat	Yes (including piered crossings)	Yes	Where appropriate
Rehabilitate/reestablish local provenance native vegetation	Yes	Yes	Where appropriate
Locate services outside the core riparian zone wherever possible	Yes	Yes	
Locate playing fields and recreational activities outside core riparian zone	Yes	Yes	
Treat stormwater runoff before discharge into riparian zone or the watercourse	Yes	Yes	Yes

-
- (vii) placing services (power, water, sewerage, and water quality treatment ponds) outside the CRZ. Encroachment into the non core riparian area may be possible if the impact on riparian functions is minimal and integrity is maintained;
 - (viii) providing a suitable interface between the riparian area and urban development (roads, playing fields, open space) to minimise edge effects;
 - (ix) minimising the number of road crossings;
 - (x) maintain riparian connectivity by using peered crossings in preference to pipes or culverts
 - (xi) minimise the impact of walkways, cycleways and general access points by using ecologically informed design principles;
 - (xii) locating flood compatible activities (playing fields) outside the CRZ. (Encroachment into the riparian area may be possible if the impact on riparian functions is minimal and integrity maintained); and
 - (xiii) treating stormwater runoff before discharge into the riparian zone of the watercourse.

(b) Category 2 – Terrestrial and Aquatic Habitat

Maintain/restore as much as possible the natural functions of a stream to:

- maintain the viability of native riparian vegetation
- provide suitable habitat for terrestrial and aquatic fauna
- provide bank stability
- protect water quality.

This is achieved by:

- (i) providing a CRZ with a minimum width of 20 metre from the top of the bank;
- (ii) wherever possible, providing sufficient (additional) riparian corridor width based on geomorphological and environmental considerations;
- (iii) as far as practicable, restoring/rehabilitating the riparian zone by returning the vegetation, geomorphic structure, hydrology and water quality of the original (pre European) condition;
- (iv) ensuring vegetation in the CRZ is at a density that would occur naturally (but see Section 5.3);
- (v) whenever possible, providing appropriate zoning that recognizes the environmental significance of the riparian land;
- (vi) minimising the number of road crossings;
- (vii) ensuring that road crossings are designed to maintain riparian connectivity;
- (viii) providing a suitable interface between the riparian area and urban development (roads, playing fields, open space) to minimise edge affects;
- (ix) minimising the extent of open parkland beside a stream;

5. Erosion Control: Management of Water

- (x) locating services (power, water, and sewerage water quality treatment ponds) outside the CRZ. Encroachment into the riparian area may be possible if the impact on riparian functions is minimised; and
- (xi) treating stormwater runoff before discharge into the riparian zone or the watercourse.

(c) Category 3 – Bank Stability and Water Quality

Minimise sedimentation and nutrient transfer to:

- provide bank stability
- protect water quality
- protect native vegetation.

This is achieved by:

- (i) where possible, emulating a naturally functioning stream;
- (ii) where possible, providing opportunity for vegetated habitat refuges (terrestrial and aquatic);
- (iii) using pipes or other engineering devices as a last resort; and
- (iv) treating stormwater runoff before discharge into the riparian zone or the watercourse.

5.3 Works Within the CRZ

5.3.1 Introduction

- (a) Works within the CRZ should maximise the retention of any existing native vegetation and minimise site disturbance.
- (b) Where practical, ensure that constructed grassed batters have gradients no steeper than 6(H):1(V) if below the 2-year ARI flood level and following the recommendations in figures 4.3 and 4.4. Waterways and spillways should be designed following Section 5.4.
- (c) Generally, the design for works in or near waterbodies should ensure the retention and enhancement of their natural functions and maintenance of fish passage. Design of permanent works should consider the following nine principles:
 - (i) *Interdependence* – all catchments should be considered as single functioning units with interchange between aquatic and riparian ecosystems, floodplains and tributaries;
 - (ii) *Individuality* – drainage designs should recognise that each catchment has individual characteristics with unique qualities;
 - (iii) *Continuity* – the linear nature of many ecosystems near waterbodies should be

-
- maintained as continuous corridors that allow living organisms to move and spread;
- (iv) *Variety* – maintain the existing habitat variety (including any living and dead vegetation, and the litter layer, soil and landform) to ensure continued biodiversity;
 - (v) *Retention of existing habitats* – existing habitats should be retained because the original habitat cannot be redeveloped in the short term;
 - (vi) *Protection of potential habitat links* – degraded section of linear habitat systems should not be further degraded and, where possible, should be rehabilitated;
 - (vii) *Adding resilience* – where possible, existing or potential linkages between waterbody systems and habitat areas or sinks (e.g. parks, reserves, forests, etc.) distant from the waterbody should be protected and/or rehabilitated;
 - (viii) *Use of natural materials* – designs should incorporate indigenous vegetation propagated from seed collected from the local area and natural materials. Hard engineering designs should be applied only in exceptional circumstances; and
 - (ix) *Multi-disciplined approach* – the design approach should seek input from different professional disciplines to cover a wide range of multi-objective approaches.
- (d) To protect and enhance various vegetation and ecological properties:
- (i) Retain natural wetlands;
 - (ii) Where vegetation must be disturbed:
 - first, assess the natural habitat and species to help design a reformed environment containing most of the features of a natural ecosystem
 - avoid clearing aquatic and semi-aquatic plants
 - investigate and incorporate suitable planting techniques for rehabilitation
 - do not use invasive species in rehabilitation (e.g. kikuyu)
 - include a broad range of endemic vegetation types (aquatic grasses, other groundcovers, shrubs and trees) in the species mix for permanent revegetation
 - do not use herbicides where they might pollute the waterbodies; and
 - (iii) Overall design should include:
 - a vegetated “core riparian zone” on the banks or shore according to the category of riparian land (see Section 5.2) or to the flood limit, whichever is greatest
 - a diverse and stable environment in and near the waterbody
 - an outer buffer zone of grass or appropriate pollution interception strategy (WSUD system, constructed wetland, or other approved system) to protect the waterbody and its riparian zone.
- (e) When designing individual catchment configurations:
- (i) Retain naturally functioning streams and, if necessary, engineer drainage lines to reflect natural functions, including the maintenance of fish passage;

5. Erosion Control: Management of Water

- (ii) Avoid the aggregation of several subcatchments to a common discharge point; and
 - (iii) Clearly define maintenance requirements before design starts to reduce needs/costs associated with clearing and mowing.
- (f) Hay bales should never be used for sediment control where seed from them can wash into waterways or foreshore areas promoting weed growth. Straw bales consisting of crop stubble do not contain seed and do not have this problem. Both straw and hay bales are less durable than many other sediment control products, often considerably so.^[3]
- (g) Where works are to be undertaken within the 2-year flood level, measures should be incorporated that ensure the C-factors are always below 0.05 during possible erosion events. Further, measures to reduce the C-factors to this level should remain stable under concentrated water flow conditions where appropriate. Above all, works should not result in or be likely to cause sediment pollution, either directly or indirectly.^[4]
- (h) Critical aspects of in-stream works should be scheduled for forecasted dry weather periods.
- (i) Where works occur in or close to watercourses, the Site Supervisor or someone nominated by him/her, should record in a notebook each day:
- the C-factor status at various positions along the watercourse
 - publicised weather forecasts.

5.3.2 Protection of Riparian/foreshore/intertidal Areas

- (a) Riparian/foreshore/intertidal areas support unique and delicate ecosystems and works here should be undertaken with the least impact possible. A special problem here is caused by unpredictable flood events or high tides that can wash equipment and materials away, polluting waters and, in some instances, causing navigational hazards. The following general management measures should be applied:
- (i) Minimise land disturbance activities to those absolutely necessary to complete the works;
 - (ii) During construction activities, stockpile or store materials away from the 40-metre zone, where practical, and certainly outside the intertidal area;
 - (iii) Ensure that no damage occurs to watercourse or intertidal rocks and the organisms that live on them by equipment, machinery or any other activity;

3. Foreshore lands are between the high and low watermarks.

4. Works should be undertaken, preferably, in the period when the rainfall erosion index (*E*) is likely to be low and lands in Soil Loss Classes 5, 6 and 7 can be disturbed (Table 4.2).

-
- (iv) Note and avoid any areas of seagrasses or kelp; and
 - (v) Store suitable spill control materials in easily accessible locations at all times during construction works.
- (b) Generally, the philosophies and techniques for erosion and sediment control on foreshore lands are similar to those applied to any site where erosion can occur (Section 5.3). However, where works are being undertaken close to waterways or intertidal zones, management measures should be designed to adapt to different influences.
- (c) Wherever possible, erosion and sediment control measures should be located above high tide marks and the 2-year ARI flood to prevent impacts from concentrated water flows, or tidal or wave action.
- (d) Barges are commonly used to get to waterfront sites during construction because of limited landward access. Management measures that relate to use of barges in the foreshore environment for construction purposes include:
- (i) Only use barges where, in the context of the overall development, they offer the best environmental outcome;
 - (ii) In shallow water, only use self-propelled barges at suitably high tides where adequate clearances are available to prevent disturbances to seabeds and prevent damage to subtidal and intertidal rocks, kelp or seagrasses;
 - (iii) Where barges might collide with seawalls due to wave and wash conditions, use protective measures such as fenders or rubber tyres to prevent damages to the seawall.
 - (iv) Do not use screw piles in waters where a potential occurs to encounter rock;
 - (v) Floating sediment curtains should be deployed while materials and/or equipment are being transferred on and off barges to provide secondary containment for any spills; and
 - (vi) Materials being transported on and off barges must be adequately secured.

5.3.3 Works in Watercourses

- (a) Apply the following general hydrological design guidelines:
- (i) Maintain the “natural” channel and floodplain form. If a watercourse has been modified already, any channel works proposed should be based on designs that resemble the natural forms of that channel. In modified systems, the advice of a suitably qualified and experienced fluvial geomorphologist should be sought. In some cases, a natural system in a similar catchment nearby can be used as a guide for channel design.
 - (ii) In emulating the natural form, watercourse design should include floodplains,

5. Erosion Control: Management of Water

- terraces and other features typical of the natural systems;
- (iii) Where possible, runoff characteristics associated with high runoff coefficient land uses should be modified to as near to the natural condition as practicable before entering a watercourse. The aim is to try to mimic the predevelopment flow regimes.
 - (iv) Detention basins/wetland systems:
 - should be designed to handle any increased runoff associated with the development so that no impact on watercourses occurs
 - should be built away from:
 - watercourses
 - natural wetlands
 - where possible, remnant natural vegetation;
 - (v) Drainage discharge points (outlet pipes and spillways) should follow the requirements of Section 5.3.5, below.
- (b) Apply the following geomorphic design guidelines to streams:
- (i) Construction and maintenance activities should be designed to avoid erosion of waterways through removal of vegetation or sediment from beds or banks;
 - (ii) Channel form, shape and cross-section at different sections of the river should mimic the natural stable conditions – channel dimensions should not be enlarged to cater for bigger flood events;
 - (iii) Design should be based on simulated stream hydrology to allow design of in-stream features, such as pool-riffle sequences, and not just peak flows;^[5]
 - (iv) Watercourses should include characteristics typical of natural watercourses in the area. These might or might not include meanders, wet, low flow channels with pools and riffles, or bars and benches;
 - (v) The dimensions of watercourse cross-sections and in-stream features can be determined from the existing stream, if it is still present. Where it is not present, the nearest similar stream should be used as a guide;
 - (vi) Include pools and riffles (figure 5.1), where the length of reaches should be five to seven times the observed bank full width. Pool areas might need to be excavated with the removed sediment being used to build up the bank around the outside of a bend. Riffle areas can be restored with gravel or rock placed within the channel between the pools. The appropriate type of rock or gravel and its placement can be determined by viewing similar riffles upstream and

5. Riffles are shallow areas between pools. They are important for fish passage and aeration due to hydraulic jump (figure 5.1). Usually, pools are within the curves of meander bends while riffles are within straighter sections, but they can simply be depressions in streams. Mostly, pools have fine-grained sediment beds while riffles have rocky or gravelly beds. Generally, pool-riffle pairs occur every five to seven channel widths along a stream channel.



Figure 5.1 Pool and riffle zone sequence

downstream, or in similar nearby intact meandering systems. Adjustments might need to be undertaken to the structural works after flood events. Note that meandering channels are never permanently stable and their shape will change in time;

(vii) In relation to riffle zones:

- calculate tractive forces for conditions to determine the minimum rock size for riffles where:
 - the average channel slope and bank full depths occur throughout the reach
 - critical flows are assumed to occur on riffle faces at 20(H):1(V) slopes
- ensure slopes do not exceed the 20(H):1(V) gradient
- ensure crests follow the average slope of the stream reach^[6]
- ensure the largest boulders are placed on the channel bottom at the crest of the riffle while the smallest boulders are set aside until the downstream slope is nearly complete; and

6. Riffle crests are elevated pools that extend upstream to the midpoint of the upstream riffle slope. They form stilling basins that improve fish passage and reduce scour.

5. Erosion Control: Management of Water

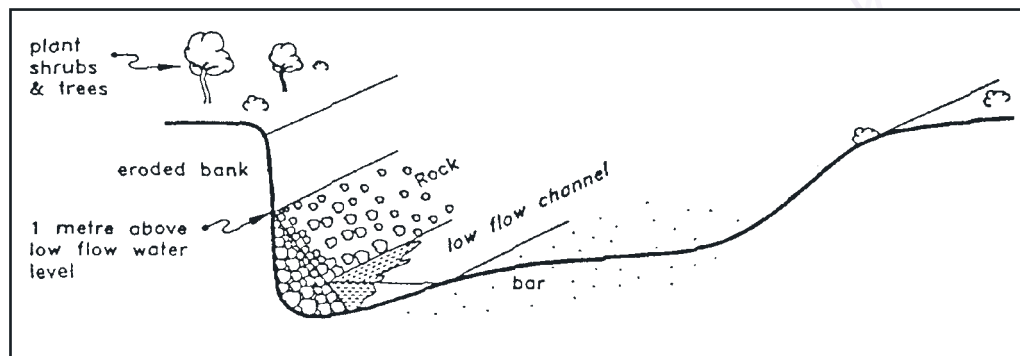


Figure 5.2 Use of rock to stabilise a stream bank (DLWC, 1994)

- (viii) The average radius of the curvature of meander bends should be 2.4 times the bank full width.
- (c) *Revetment and Vegetation*. Various techniques are available to help stabilise stream-banks. This one, which involves placing rock that cannot be washed away against the base of the bank to hold it in place (figure 5.2), must be designed by an appropriately skilled person. The rock needs to be hard, angular in shape, resistant to weathering and water action, and free from soil and vegetation. The practice is suitable for most situations except very narrow streams where the rock could block a large part of the channel. The procedure for implementing this technique is:
- (i) Place the rock directly on the site, taking care to ensure that the range of sizes remains well mixed. If the eroded bank is high, form an access track to get to the base of the bank;
 - (ii) At 1-metre centres, plant:
 - shrubs behind the wall and along the upper part and top of the bank
 - trees along the top of the bank starting at a distance back from the bank equal to three times the bank height.
- Establish groundcover over all areas at densities of four plants per square metre. Water all plants until they are established.
- (d) *Planting the Common Reed, Phragmites australis*. With this technique, a dense growth of *Phragmites australis* is established along the bank. The reeds slow the flow and trap sediment, minimising scour and undercutting of the bank, while providing improved riparian and aquatic habitats. Groynes might be necessary if active erosion is already occurring. The technique is suitable for most situations where grazing

control can be provided. However, it should not be used for very narrow streams (where flow might be obstructed) or where streams are perched above the floodplain and a breakout and course change is possible. *Phragmites australis* is effective because of its ability to grow in 1 to 2 metres of water and up steep banks above normal water level to provide bank protection against variable water levels. This technique is excellent for water quality improvement in tributaries and to build up the floor of gullies. The procedure for implementing this technique is:

- (i) If necessary, construct groynes to provide bank stability;
 - (ii) Collect reeds for planting, either by transplanting them from an existing stand, harvesting seed and growing seedlings, or by taking cuttings in early spring. Plants might be available commercially;
 - (iii) Planting position and time depends on the bank shape and stream hydrology. Plant where and when moisture is consistent, without long periods of inundation of greater than 300 mm until the seedlings are established (generally one year). Plant at spaces of 300 to 500 mm if sufficient material is available, or in clumps. If bank shape allows, plant several rows; and
 - (iv) Use slow release fertiliser tablets in planting holes if the nutrient levels of the soils are low.
- (e) *Bendway Weirs*. These should be designed by an appropriately experienced person. They are low level, upstream angled, stone sills attached to the outer banks of bends in smaller rivers or watercourses (Derrick, 1996). Typically, the weirs are:
- angled 10 to 25 degrees upstream (into the flow)
 - built of well-graded stones with an upper weight limit of 300 to 450 kilograms;
 - built in sets spaced 20 to 30 metres apart
 - built 0.6 metres high at the stream end, rising to 1.2 metres at the bank end and keyed into the bank with lengths varying from one-quarter to one-half the width of the river at base flow.

They redirect water flowing over the weir at an angle perpendicular to the axis of the weir and break up the stream's strong secondary currents in bends. Consequently, flow is directed away from the outer bank of the bend towards the point bar reducing near bank velocities and erosion. Other benefits include improved aquatic habitats with the overall increase in stream depths, stable scour holes and velocity redistribution (even during low flow). In addition, pool-riffle regimes can be reestablished and any existing vegetation can be stabilised.

- (f) *Reconstructing Vegetated Meander Bends in Straightened Channels*. This technique is used to restore the natural meandering streambed pattern where these have been artificially straightened or have eroded into straight channels. Consequently, it requires the reconstruction of meander bends and pool and riffle sequences, the

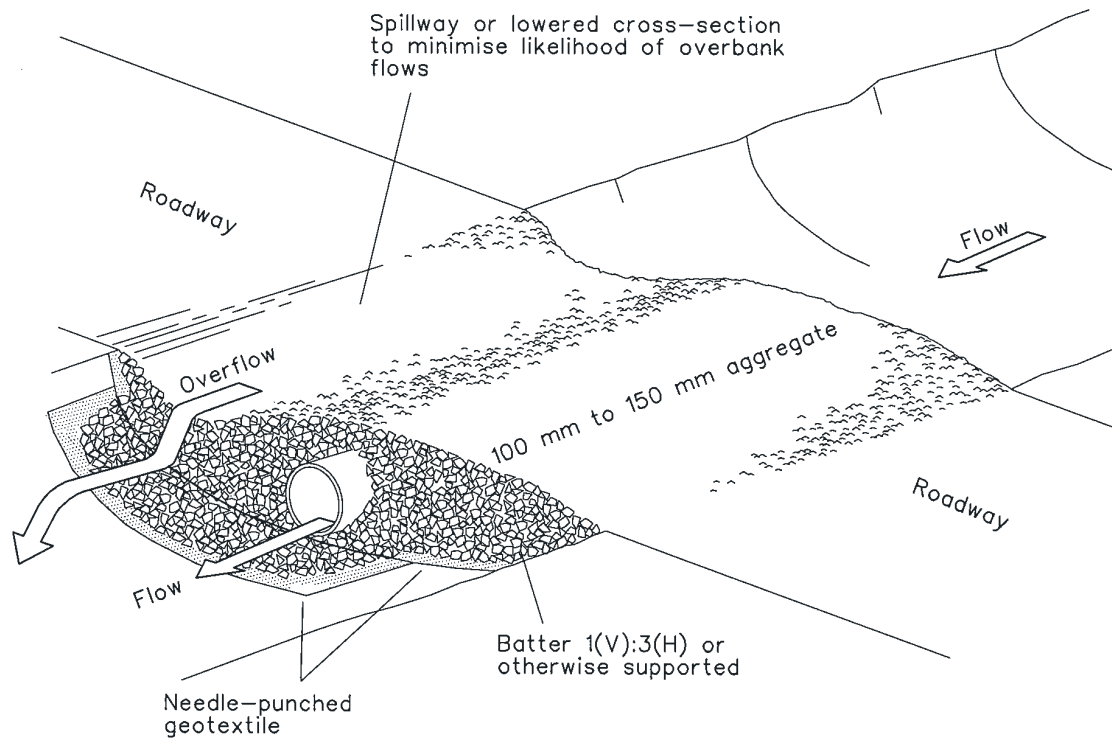
5. Erosion Control: Management of Water

shape and dimensions of which can be determined from aerial photographs, parish maps, portion plans, topographic maps, etc. Construction should begin upstream at the junction of the remaining intact meandering channel and the straight channel and continue downstream. Channel units that could need to be constructed include:

- (i) The outside of curved banks of the meander bends. Some form of armouring should protect the toe of the bank until vegetation (grasses and shrubs planted with the structural works) becomes established. These works are placed outside the meander bends from just above the upstream point of inflection, around the bend, to just below the downstream point of inflection;
- (ii) The inside of the bends (point bars). When flows start going around the new bends, point bars will naturally start to deposit on the insides of the bends; and
- (iii) Pools and riffles.

5.3.4 Temporary Waterway Crossings

- (a) Temporary waterway crossings are usually formed using culverts or pipes to carry flow under a raised gravel carriageway that allows vehicles to cross the stabilised waterway safely without causing damage and erosion.
- (b) The following standard design criteria (Standard Drawing 5-1) should be followed:
 - (i) prohibit traffic until the access way is constructed;
 - (ii) Use a clean, rigid, non polluting aggregate or gravel (100 to 150 mm aggregate);
 - (iii) Support the gravel on needle-punched geotextile;
 - (iv) Have a minimum depth of 200 mm of gravel;
 - (v) Provide a 3-metre wide carriage way and sufficient length of culvert pipe to allow less than a 1(V):3(H) slope on side batters;
 - (vi) Provide a lower section to act as an emergency spillway in greater than the design storm events (Section 2.3.1 (e)); and
 - (vii) Ensure that culvert outlets extend beyond the toe of the fill embankments.
- (c) The following maintenance issues should be noted:
 - (i) Keep the pipe culvert clear to avoid bypassing by storm flows less than the design storm event due to blockages from debris or sediment;
 - (ii) Recover gravel to maintain minimum depth of 200 mm;
 - (iii) Remove the crossing when it is no longer required; and
 - (iv) Rehabilitate the area following the vegetation management plan or other site rehabilitation plan.
- (d) In addition, consideration should be given to the following limitations:
 - (i) Oils or other potentially hazardous materials should not be used as surface treatment;



Construction Notes

1. Prohibit all traffic until the access way is constructed.
2. Strip any topsoil and place a needle-punched textile over the base of the crossing.
3. Place clean, rigid, non polluting aggregate or gravel in the 100 mm to 150 mm size class over the fabric to a minimum depth of 200 mm.
4. Provide a 3-metre wide carriageway with sufficient length of culvert pipe to allow less than a 3(H): 1 (V) slope on side batters.
5. Install a lower section to act as an emergency spillway in greater than design storm events.
6. Ensure that culvert outlets extend beyond the toe of fill embankments.

5. Erosion Control: Management of Water

- (ii) Upstream flooding problems need to be assessed;
- (iii) Downstream flooding in times of overtopping needs to be assessed;
- (iv) Activities that might affect water quality should be addressed.
- (v) Also, see Section 5.2 regarding special requirements for working closer than 40 metres from waterways.

5.3.5 Construction of Culverts and Bridges

- (a) When working in creeks or rivers, careful planning is required to limit the impact of sediment pollution occurring because of works.
- (b) Where possible, divert water (by pipe or bank) around culverts and/or bridges during construction so that the entire system is stable at least up to the 2-year ARI storm event. The formation of temporary dams and draining or pumping of water around the site to control polluted waters should be undertaken with all care.
- (c) Where culverts intercept table drain flows, construct culvert headwalls with sufficient height and width to ensure flows in the drains do not bypass or overtop the inlet headwall. Culvert outlets should normally extend beyond the toe of fill embankments. Further, outlets should be designed and constructed so that they align evenly with surrounding landforms and do not protrude. Where possible, all outlets to watercourses should be of a natural form, using riprap packed with soil and planted with sedges, rushes and grasses as scour protection. The use of concrete headwalls should be avoided.
- (d) Care should be exercised in the construction of sediment basins (Section 6.3.3) on waterways below these works. While sediment control is important, sometimes the effect of disturbance of waterways for basin construction can cause more damage than can be gained by their presence. Innovative techniques are encouraged, such as using floating booms, turbidity curtains and similar devices. Sediment basins should not be constructed in line on a watercourse.
- (e) See Section 5.2 regarding special requirements for working closer than 40 metres from waterways.

5.4 Regular Site Drainage Works

5.4.1 General Recommendations

- (a) Install site drainage works to convey stormwater safely through and away from the site, particularly those affecting possible erosion of soil and subsequent pollution by sediment and trash. Preferably, prioritise drainage works with the most important control measures installed first.

-
- (b) Where possible, divert run-on water from lands upslope around the site while land disturbance activities are going on. Note Section 5.4.3, below, in relation to concentrating flows and “soft” outlets.^[7]
- (c) Direct water across the site at non erodible velocities in the design storm event (Section 2.3.1 (e)).^[8]
- (d) Water management programs should favour:
- (i) division of the site into smaller, more manageable catchments;
 - (ii) installation of simple structures constructed from local materials;^[9]
 - (iii) taking advantage of permanent stormwater facilities that can double as temporary soil or water control measures; and
 - (iv) the use of porous zones (e.g. grassed waterways) within the limitations of (e), below, to help natural assimilation of water pollutants and reduce runoff.
- (e) Works should not:
- adversely affect upstream or downstream properties
 - cause new seepage areas through a rise in the watertable^[10]
 - eliminate existing seepage areas that affect remnant natural ecosystems
 - increase the hazards of dryland salinity within the catchment.

5.4.2 Sheet Flows

- (a) Sheet erosion is the removal of a relatively uniform layer of soil from the land surface by rain-splash and/or water runoff. The energy in rainfall is often sufficient to loosen exposed soil particles that can be subsequently transported by water. Where practicable, reduce the sheet erosion hazard by:
- (i) protecting the ground surface with a cover of suitable vegetation or an erosion control product – note the influence of the C-factor on the erosion hazard (Appendix A);
 - (ii) reducing the volumes of water flows; and
 - (iii) reducing the velocities of water flows.
- (b) Reduce runoff volumes by leaving scarified soil surfaces (or similar) or installing

7. Do not divert stormwater onto nearby lands without obtaining earlier written approval from the affected landholder.

8. This guideline applies to both sheet flows and where water is concentrated by works, such as catch drains, waterways, drop structures, outlet structures, etc.

9. Soft local rock might not be suitable for permanent structures.

10. Often watertables in eastern Australia are saline. Where these watertables are raised into the root zone, most plant species will die and the erosion hazard rises substantially.

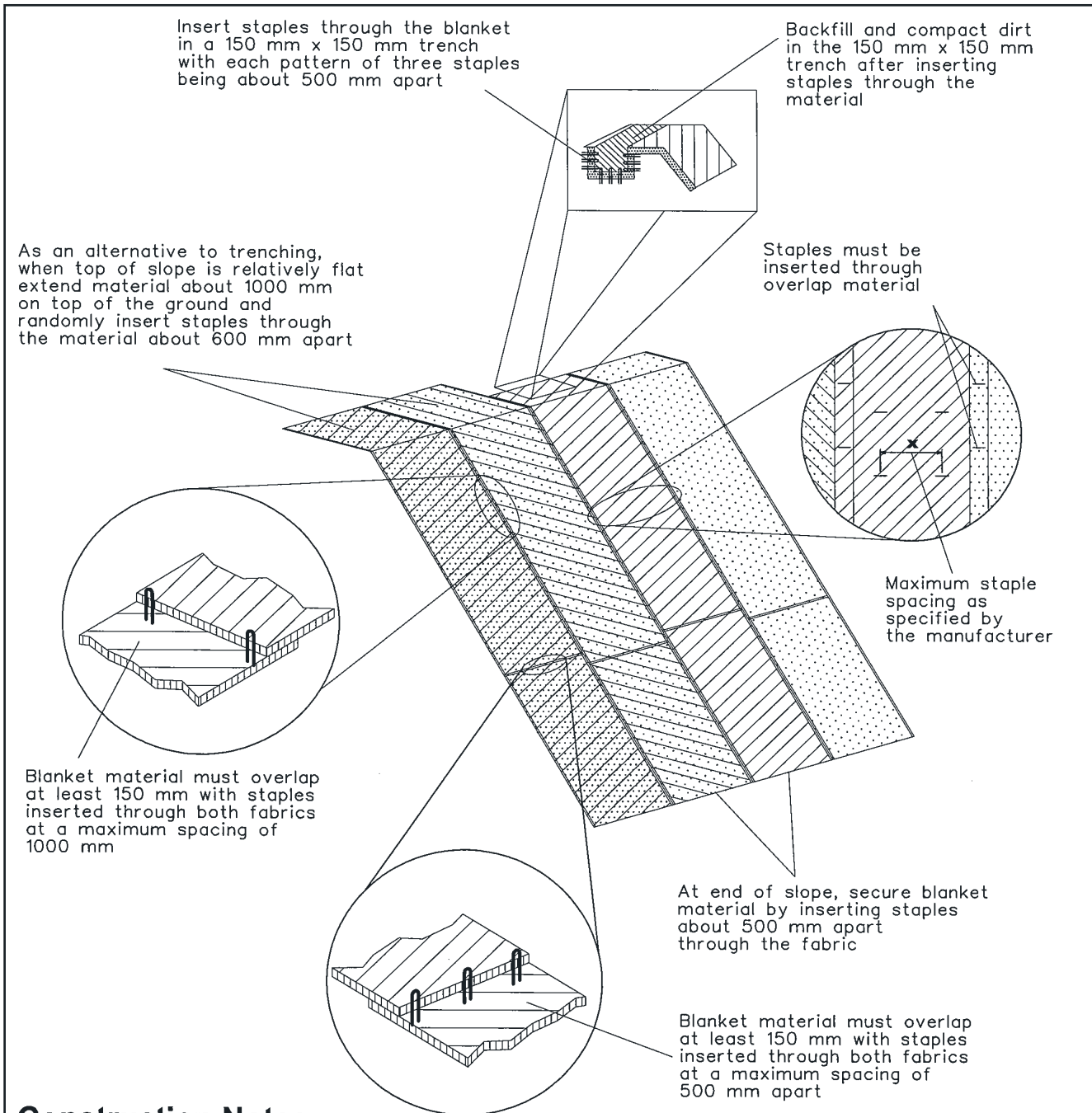
5. Erosion Control: Management of Water

contour banks to keep slopes less than 80 metres in rainfall events – note the influence of the LS-factor on the erosion hazard (Appendix A).

- (c) Protect the ground surface by encouraging infiltration of water through progressive revegetation of the site (Chapter 7), installing various erosion control products (Appendix D), cellular confinement systems, etc. Note that:
 - (i) Under certain conditions, rolled erosion control products (RECPs) can exceed the shear stress rating of rock rip rap and can be less expensive (Lancaster, *et al.*, 1997). A further benefit of RECPs is that they allow vigorous vegetation growth, offering a “softer”, more aesthetically pleasing appearance. However, proper installation of RECPs is critical for their success (Standard Drawing 5-2); and
 - (ii) Cellular confinement systems are available with or without perforated sides. Perforated sides are preferred because they allow drainage and reduce the hydrostatic loads in the cells (Standard Drawing 5-3).
- (d) Reduce water velocities by:
 - (i) keeping gradients as low as possible (Section 4.4.2 (a));
 - (ii) ensuring a good ground cover that promotes infiltration; and
 - (iii) installing banks upslope to divert flows away from the site (Section 5.4.4) and reducing slope length.

5.4.3 Concentrated Flows

- (a) Waters are concentrated in drains for interception/diversion of surface or subsurface flows and to convey these to stable outlets, for example:
 - (i) to intercept offsite run-on water;
 - (ii) to intercept spring water, especially in areas with moderate or high hazards of landslip;
 - (iii) to divert water from cut or fill slopes;
 - (iv) to shorten long lengths of slope, particularly on lands with high soil erosion hazards, such as earth batters, unpaved roads and newly seeded areas (Section 4.4.2 (a));
 - (v) to carry water down the face of a cut or fill slope; and
 - (vi) to provide the general stormwater conveyance system.
Choice of channel/drain type should depend on its purpose, materials available and cost.
- (b) Construct temporary channels/drains and their inlet and outlet works to convey water at least up to the design peak flow and remain stable, usually in the 10-year ARI time of concentration storm event. In some situations, designing it for flows from larger storm events might be necessary, e.g. to prevent damage of environmentally

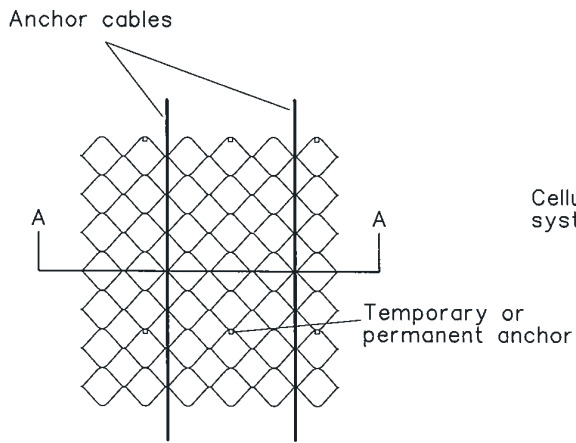


Construction Notes

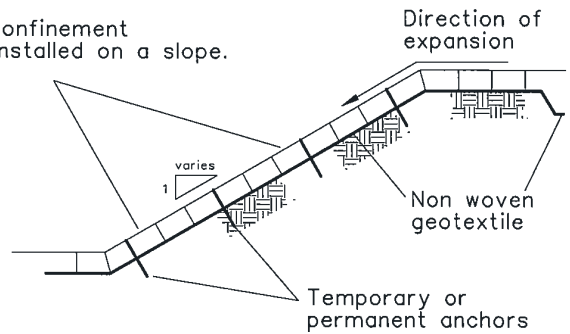
1. Remove any rocks, clods, sticks or grass from the ground surface before laying the matting.
2. Spread topsoil to at least 75 mm depth.
3. Where appropriate, complete fertilising and seeding on a properly prepared seedbed (Standard Drawing 7-1) before laying the matting.
4. Ensure the fabric can be continuously in contact with the soil by grading the surface carefully first.
5. Lay the matting in "shingle-fashion" with the ends of each upstream roll overlapping the next roll downslope.
6. Ensure sufficient staples are used to maintain a good contact between the soil and the matting.

RECP : SHEET FLOW

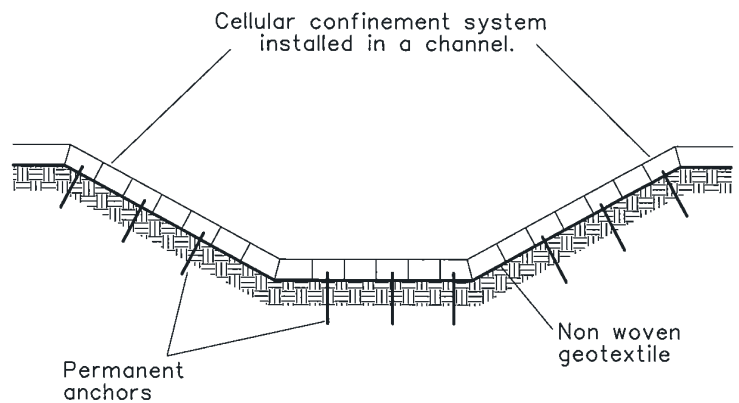
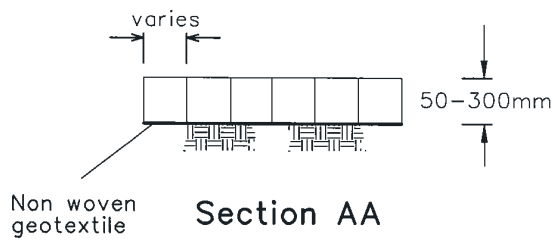
SD 5-2



Cellular confinement system installed on a slope.



Slope Protection System



Channel Protection System

Construction Notes

1. Undertake design only with the help of a suitably qualified geotechnical engineer.
2. Anchor systems on steep slopes to prevent sliding or movement under gravitational forces. This might include the use of high tensile, low creep cables made of polyester (not polypropylene), rope or steel wire.
3. Place thick, non woven geotextiles under the cellular confinement system to allow for lateral drainage.
4. Fill the cells with soil, rock or concrete depending on the application.

sensitive areas and/or where failure is likely to result in substantial loss of property or a danger to life.

- (c) Also, design any permanent channels/drains and inlet and outlet works to convey water at least up to the design peak flow and remain stable, usually in the 10-year ARI time of concentration storm event. However, follow council's guideline where different to this.
- (d) For all water conveyance structures, adopt the recommendations shown at Appendix F for calculation of peak flow runoff coefficients (C_{10}) where the lands are disturbed by removal of vegetation and topsoil (common on construction sites and mining sites). Where the lands are not so disturbed, apply the criteria shown in Pilgrim (1998).
- (e) Reduce the erosive energy levels of concentrated water in constructed channels by:
 - constructing channels/drains with a parabolic or trapezoidal cross-section (rather than V-shaped)
 - widening the drain invert
 - installing check dams (figure 5.3 and Standard Drawing 5-4)
 - installing appropriate channel linings (Section 5.4.4 (d))
 - installing energy dissipaters at outlets.

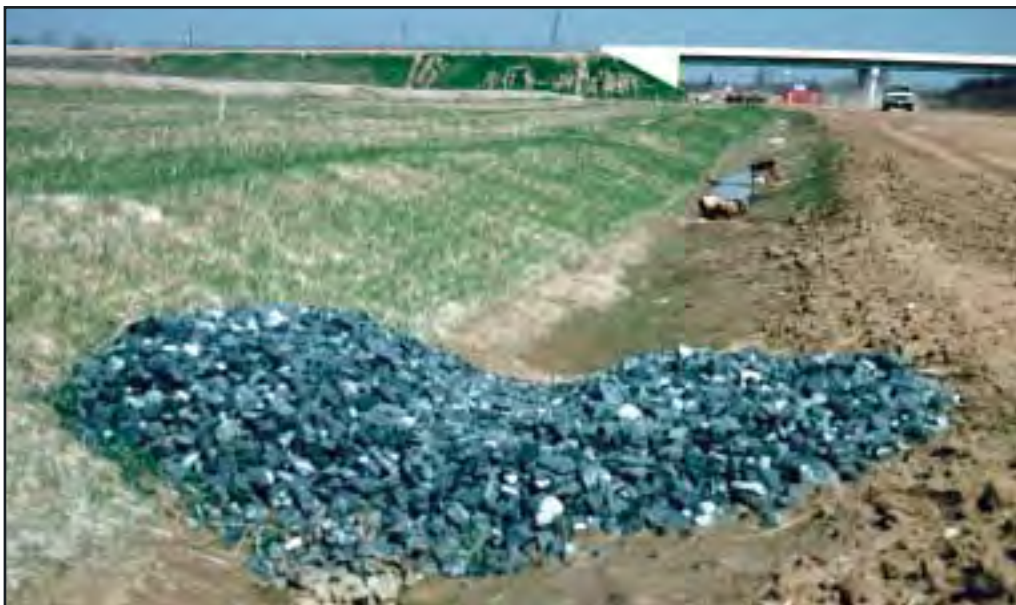


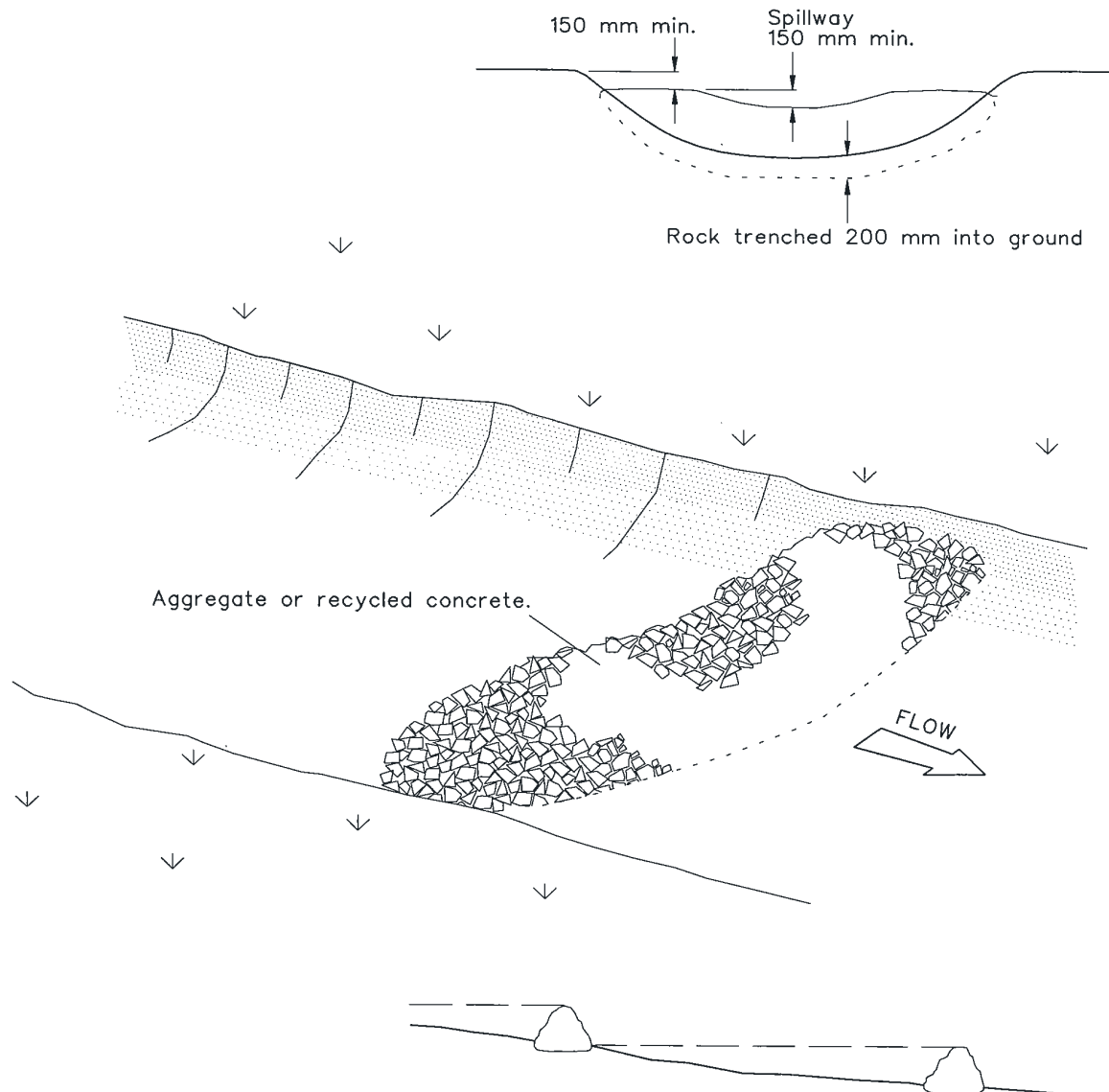
Figure 5.3(a) Use of rock check dams to reduce the erosive energy of flow

5. Erosion Control: Management of Water



Figure 5.3(b)
Alternate check dam system. Where products like these are used, they should be installed with an appropriate erosion control blanket below them and covering at least 0.7 metres each side (c.f. SD 5-4)

- (g) Outlets from all water conveyance structures should discharge water such that the erosion hazard to downslope lands and waterways is no greater than in the predevelopment condition up to the design storm event (Section 2.3.1 (e)). This can be achieved through use of water detention basins, waterways that increase the time of concentration, energy dissipaters, level spreaders, etc. Where permanent outlets discharge to watercourses, works should be of a "soft" design.
- (h) Where appropriate, preparation for grassed waterway construction should involve:
- removal of trees, stumps and other debris that might impede flow of water or earthworks
 - stripping and stockpiling of topsoil (Section 4.3.2)
 - shaping the channel (to eliminate irregularities that would interfere with flow of water and provide a stable cross-section) and resspreading topsoil
 - applying appropriate ameliorants and/or fertilisers if rehabilitating by vegetative means (Section 7.2)
 - applying ground covers.



Spacing of check dams along centreline and scour protection below each check dam to be specified on SWMP/ESCP

Construction Notes

1. Check dams can be built with various materials, including rocks, logs, sandbags and straw bales. The maintenance program should ensure their integrity is retained, especially where constructed with straw bales. In the case of bales, this might require their replacement each two to four months.
2. Trench the check dam 200 mm into the ground across its whole width. Where rock is used, fill the trenches to at least 100 mm above the ground surface to reduce the risk of undercutting.
3. Normally, their maximum height should not exceed 600 mm above the gully floor. The centre should act as a spillway, being at least 150 mm lower than the outer edges.
4. Space the dams so the toe of the upstream dam is level with the spillway of the next downstream dam.

ROCK CHECK DAM

SD 5-4

5. Erosion Control: Management of Water

- (i) Where practical to do so, ensure that the design of permanent waterways mimics natural ecosystems. Use of rock and gravel, and planting out with local native vegetation can create waterways that are functional both for conveying discharges and as habitats and biological linkages. More information on the design of permanent waterways is contained in *Managing Urban Stormwater: Urban Design* (DEC, *in prep.*).

5.4.4 Temporary Water Diversion Structures

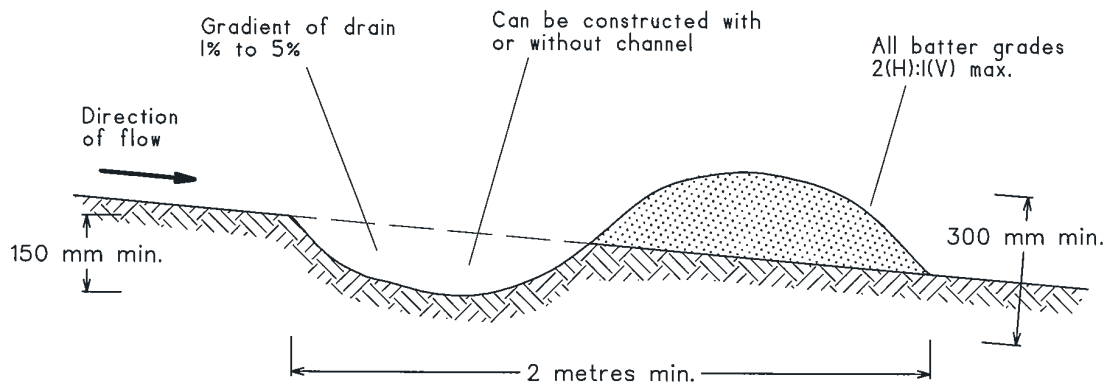
- (a) Water diversion structures can be constructed from a wide range of substances, such as compacted earth, plastic sheeting, shotcrete, asphalt and pipes.
- (b) As a first step in the design process, ensure that the route to be taken is considerate of all opportunities and constraints present at the site (Chapter 3). Select a route that avoids trees, preferably beyond their drip line, service infrastructure, etc.
- (c) Where water diversion structures will outlet to downstream receiving waters (Section 5.3.5), ensure suitable water quality and quantity control structures are installed so that discharges meet the relevant guidelines. Ideally, discharge rates should mimic natural flows in terms of magnitude, seasonality, frequency and variability. Place any water quality and quantity control structures above the riparian zone, such as oil/grease interceptors, sediment traps/basins, litter traps, constructed wetlands and detention basins.
- (d) Velocities should not exceed those recommended in Table 5.2 for the design storm event (Section 2.3.1 (e)).
- (e) The design of *earth-based diversion structures* should not exceed those recommended in Table 5.1 in the design storm event (Section 2.3.1 (e)). The structures should be built following Standard Drawings 5-5 and 5-6. In addition, the following issues should be considered:
 - additional lands that might be disturbed
 - structures that need to be stabilised immediately
 - downstream flow changes that need to be carefully assessed.
- (f) Construct grassed waterways following processes that ensure an adequate root zone (Section 7.3). Note that:
 - (i) Where concentrated flows cannot be avoided immediately after planting, either initiate the grass lining with turf or where seed is used, protect the surface with a biodegradable mat; and
 - (ii) Ensure that grass cover is total and permanent, particularly in all areas of possible concentrated flow. Reestablishment might be necessary in bare areas, including replacement of any lost topsoil.

Table 5.2 Maximum Design Flow Velocities in Waterways (compiled from various sources)

Material		Aggregate size (mm)	Critical velocity (m/second)						
Type	Thickness (m)								
Gabions and reno mattresses	0.50	120-250	6.4						
	0.50	100-200	5.8						
	0.30	100-150	5.0						
	0.30	70-120	4.2						
	0.25	70-100	3.6						
	0.17	70-100	3.5						
Loose rock (assume 100 percent soil cover)	Weight each (kg)		Turbulent flow						
	1,000		Normal flow						
	500		4.8	6.6					
	100		4.2	5.7					
	50		3.3	4.5					
Revetment mattresses	Form		2.8	3.8					
	Storm mattress		2.3	3.0					
	200 mm fp		>6.0						
	125 mm fp		6.0						
		100 mm fp	4.0						
			2.0						
Critical velocity (m/second)									
Material	Inundation <6 hours		Inundation <12 hours		Inundation <24 hours		Inundation <48 hours		
	Soil erodibility		Soil erodibility		Soil erodibility		Soil erodibility		
	Low	Moderate	High	Low	Moderate	High	Low	Moderate	High
High performance bonded plastic fibres (vegetated)	7.0	7.0	7.0	6.0	6.0	6.0	5.0	4.0	4.0
Plastic fibres with netting	5.0	5.0	5.0	4.3	4.3	4.3	3.6	3.0	3.0
Mesh reinforced pregrown turf	3.0	2.7	2.4	2.6	2.3	2.0	2.0	1.8	1.6
Kiku yu	2.5	2.2	1.9	2.1	1.9	1.6	1.7	1.4	1.2
Jute or coir mesh (close weave, bitumen sprayed)	2.3	2.0	1.7	1.9	1.7	1.5	1.5	1.3	1.1
Coconut/ jute fibre mats	2.3	2.0	1.7	1.9	1.7	1.5	1.5	1.3	1.1
Couch , carpet grass , Rhodes grass , etc.	2.0	1.8	1.4	1.7	1.5	1.2	1.4	1.1	0.9
Bare soil	0.7	0.5	0.3	0.6	0.4	0.3	0.4	0.3	0.2

Assume that all soils with 10 percent or more dispersible fines have high erodibilities. Of those with less, soils with K-factors below 0.02 have low erodibilities, those between 0.02 and 0.045 have moderate erodibilities, while those above 0.045 have high erodibilities.

In addition, the figures here assume slope gradients of less than 10 percent and, where appropriate, good (>80 percent) ground cover. If good ground cover is not expected to be maintained properly (might die back seasonally or during short periods of drought) and is critical to the system, reduce all velocities by 1.0 metre per second. Alternately, seek the manufacturer's advice if these conditions are unlikely to be met.



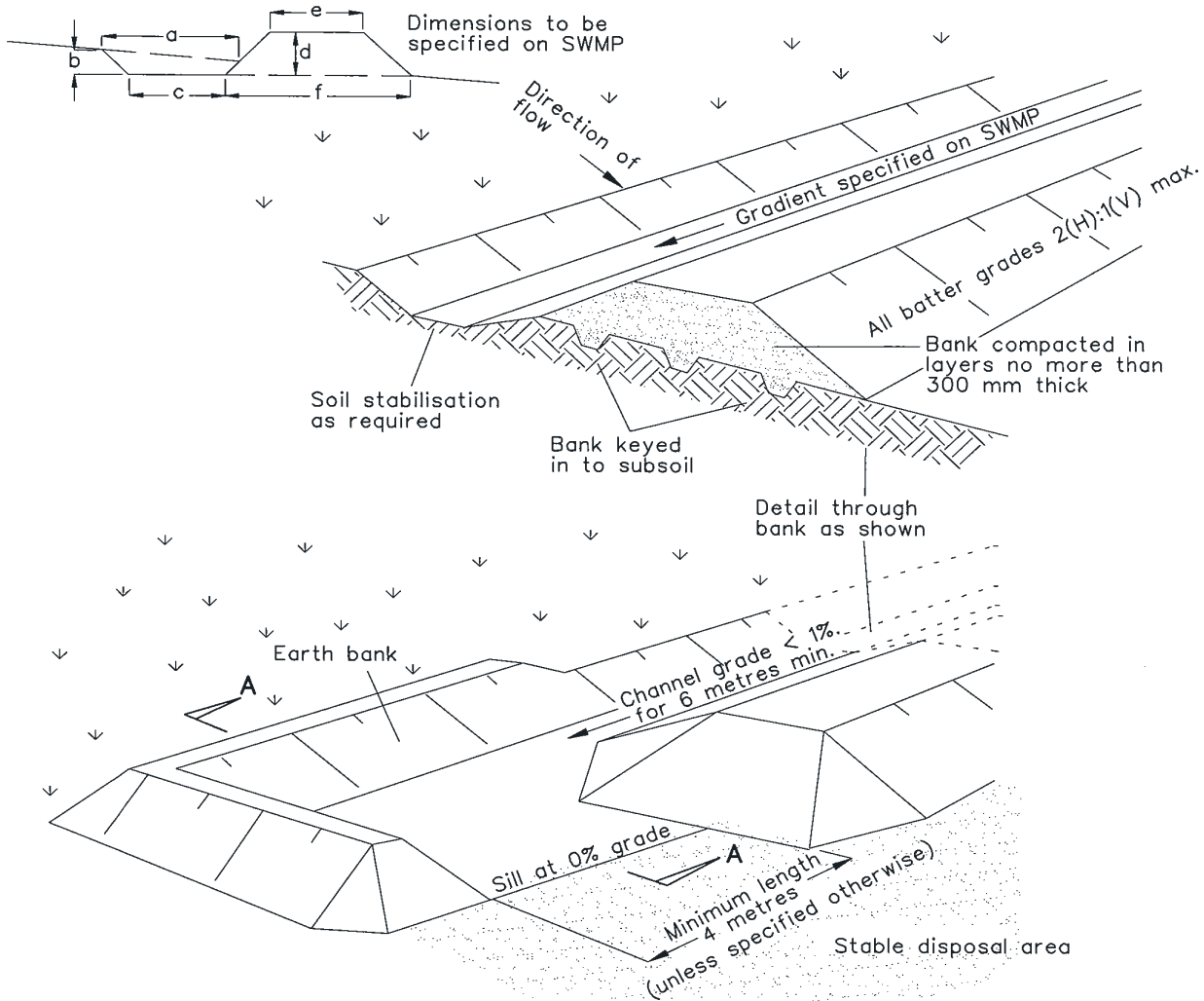
NOTE: Only to be used as temporary bank where maximum upslope length is 80 metres.

Construction Notes

1. Build with gradients between 1 percent and 5 percent.
2. Avoid removing trees and shrubs if possible - work around them.
3. Ensure the structures are free of projections or other irregularities that could impede water flow.
4. Build the drains with circular, parabolic or trapezoidal cross sections, not V shaped.
5. Ensure the banks are properly compacted to prevent failure.
6. Complete permanent or temporary stabilisation within 10 days of construction.

EARTH BANK (LOW FLOW)

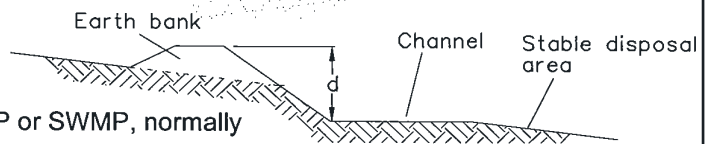
SD 5-5



Level Spreader (or Sill)

Construction Notes

1. Construct at the gradient specified on the ESCP or SWMP, normally between 1 and 5 percent
2. Avoid removing trees and shrubs if possible - work around them.
3. Ensure the structures are free of projections or other irregularities that could impede water flow.
4. Build the drains with circular, parabolic or trapezoidal cross sections, not V-shaped, at the dimensions shown on the SWMP.
5. Ensure the banks are properly compacted to prevent failure.
6. Complete permanent or temporary stabilisation within 10 days of construction following Table 5.2 in Landcom (2004).
7. Where discharging to erodible lands, ensure they outlet through a properly constructed level spreader.
8. Construct the level spreader at the gradient specified on the ESCP or SWMP, normally less than 1 percent or level.
9. Where possible, ensure they discharge waters onto either stabilised or undisturbed disposal sites within the same subcatchment area from which the water originated. Approval might be required to discharge into other subcatchments.

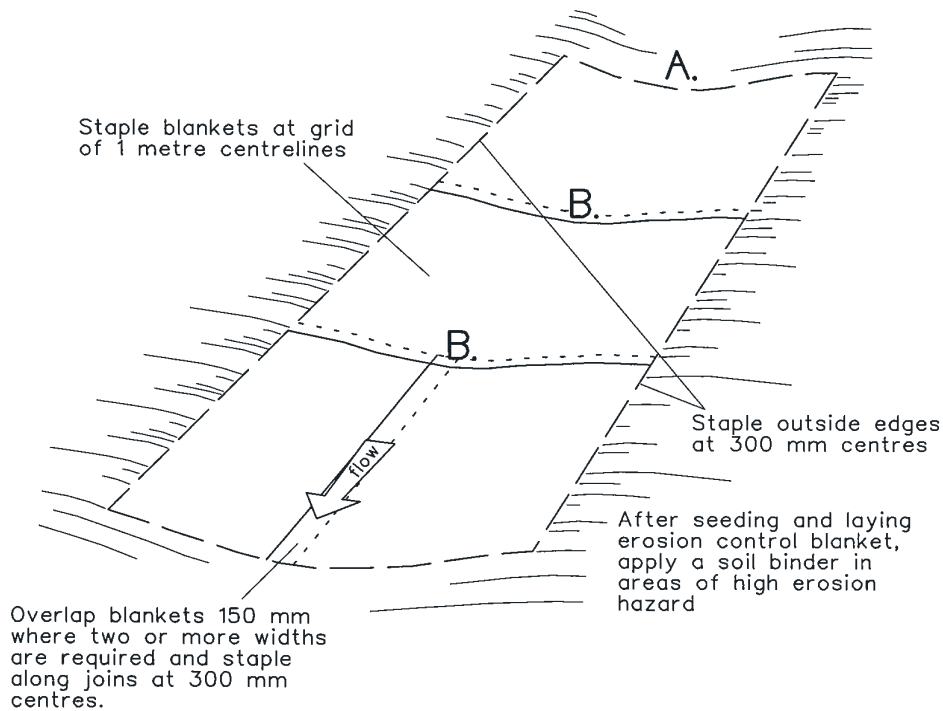


Section AA

5. Erosion Control: Management of Water

- (g) Grassed waterways should not be confused with grass swales. Rather than being simple water conveyance structures, grass swales are used to infiltrate stormwater to the watertable where the soils are Soil Hydrologic Groups A or B and the floor of the structure is at least two metres from any seasonal or permanent watertable. Grass swales should not be used to convey sediment-laden water because their infiltration abilities can be greatly reduced by it.
- (h) Consideration might be given to the use of other *fabrics*, including jute mesh and other biodegradable blankets to line waterways. These can provide temporary protection to earth-based drains intended to be removed or upgraded within six months, or grassed waterways that have only recently been established from seed or runners. Nevertheless:
- (i) Ensure topsoil is at least 75 mm deep; and
 - (ii) Install the fabric following Standard Drawing 5-7 after grading, seeding and fertilising is completed (Chapter 7) so that it is continuously in contact with the soil.^[11]
- (i) Gravel or rocks form one of the simplest kinds of linings (figure 5.4) and can be made to withstand most velocities in waterways if the proper sized materials are selected (Table 5.2). Where rocks are used, place them above a filter layer of suitable geotextile and, where necessary, properly graded layers of sand and gravel. Rocks are particularly useful in critical sections of waterways, such as bends and outlets. Gravel layers are useful for protecting any geofabric from tearing as the rocks are juggled into locking positions. Soil should be packed in all layers to:
- enable moisture transfer from the substrate to the waterway itself
 - allow sedges and grasses to be planted in the rock voids.
- The roots of the vegetation will be protected by rocks and will enhance the locking effect. Also, vegetation will add to the ecological values and impart a more pleasing aesthetic effect.
- (j) concrete, concrete-filled mattresses, shotcrete and asphalt can be used to line waterways, form chutes or to convert concentrated flow into sheet flow. Note that:
- (i) These structures should be used only in situations where ecological functions are non-existent or have no potential. Even so, these materials should never be used in watercourses.
 - (ii) Their impermeable, smooth surfaces usually result in higher velocities in drains and consequent erosion of natural waterways downstream unless protective measures are installed; and

¹¹. In this situation, omit cover crop species from the mix because they have a higher retardance effect and might cause overtopping of the drain in large storm events.



Bury the top of the blanket in a trench 300 mm or more in depth and staple at 150 mm centres. Tamp soil over blanket

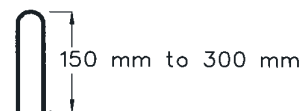


Overlap - bury upper end of lower blanket as in 'A'. Overlap end of top blanket 300 mm and staple at 150 mm centres

Fill the trench with soil and compact



Staples: 8 gauge (4mm) wire



Construction Notes

1. Remove any rocks, clods, sticks or grass from the surface before laying matting
2. Ensure that topsoil is at least 75 mm deep.
3. Complete fertilising and seeding before laying the matting.
4. Ensure fabric will be continuously in contact with the soil by grading the surface carefully first.
5. Lay the fabric in "shingle-fashion", with the end of each upstream roll overlapping those downstream. Ensure each roll is anchored properly at its upslope end (Standard Drawing 5-7b).
6. Ensure that the full width of flow in the channel is covered by the matting up to the design storm event, usually in the 10-year ARI time of concentration storm event.
7. Divert water from the structure until vegetation is stabilised properly.

5. Erosion Control: Management of Water



*Figure 5.4
A rock-lined
waterway*

- (iii) Concrete linings tend to be more durable than asphalt and require less maintenance.
- (k) Chutes (figure 5.5) should have a minimum depth of 300-mm. In addition:
- bends should be avoided
 - anchor lugs should be provided at a maximum of 3-metre intervals
 - inlet and outlet sections should be at least 1.5 metres long
 - energy dissipaters should be provided at the outlet to bring the flow to non erosive velocities.

Concrete chutes should never be used in watercourses. Use riprap instead.

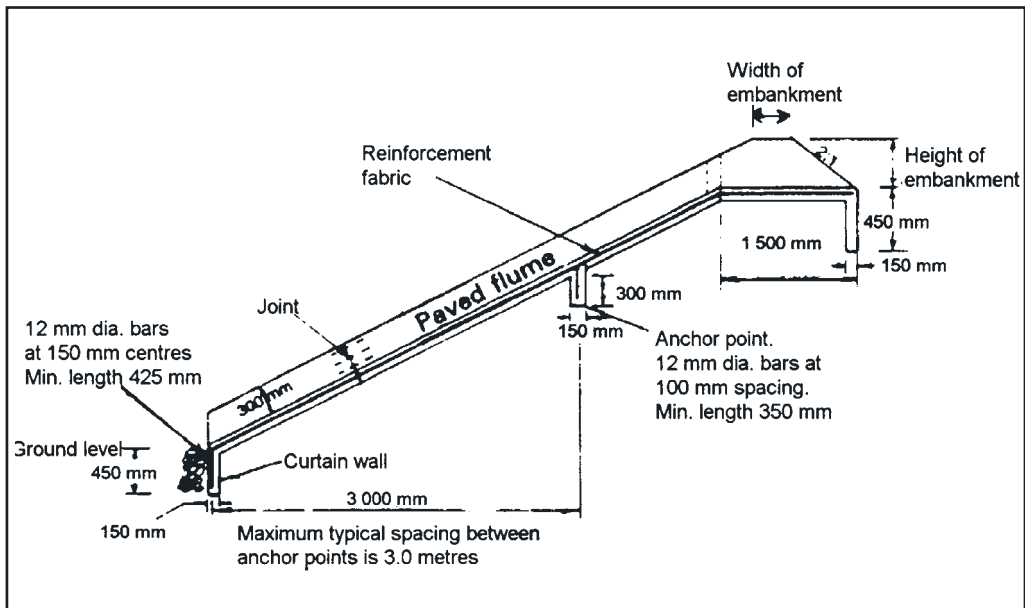


Figure 5.5 Cross-section of a typical paved chute (adapted from Virginia SWCC, 1980)

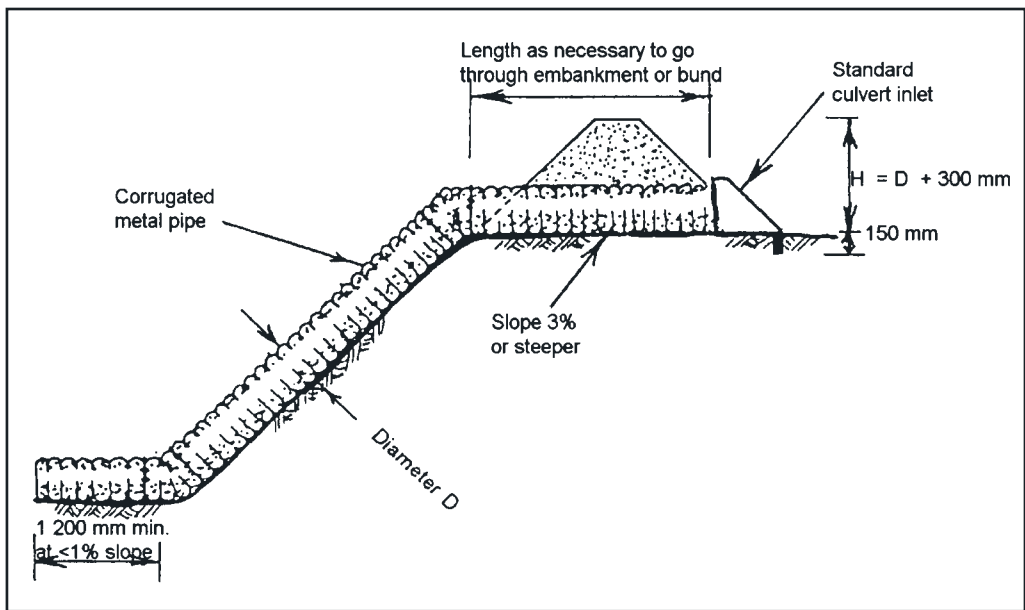


Figure 5.6 Cross-section of a typical pipe drain (adapted from USDA, 1975).

5. Erosion Control: Management of Water



Figure 5.7 Use of heavy-duty flexible pipe to carry water down a batter

- (l) Pipes. Half-round corrugated metal or concrete pipes or heavy-duty flexible pipes (figures 5.6 and 5.7) can be used as drains to transport water down steep slopes, e.g. batters. Install them progressively as construction proceeds and their design criteria should include an inlet section with a slope of greater than 3 percent. Ensure any embankment over the inlet of the pipe is a minimum of 300 mm higher than the soffit, and the soil around and under it compacted at least by hand and in half metre layers.

5.4.5 Energy Dissipaters and Outlet Protection

- (a) Energy dissipaters can be used to mitigate erosion of drains and their outlets through reductions in water velocity. They are usually permanent structures and constructed with riprap, grouted riprap, gabions, recycled concrete or concrete. Where possible, concrete, grouted riprap, recycled concrete and mesh structures should not be used in watercourses. Rather, they should be constructed of riprap consisting of angular run-of-quarry durable rock and designed to mimic the natural function and appearance of the watercourse.
- (b) Drains should discharge water to stable disposal areas including:



*Figure 5.8
A riprap outlet
on a steep slope.*

- well-vegetated or otherwise stable lands (figure 5.8)
 - other temporary diversions, drop-down structures^[12] or culverts
 - watercourses.
- (c) Where structures outlet to a watercourse, ensure they:
- do not protrude beyond the stream bank and align evenly with it
 - are placed at the invert level of the stream
 - point downstream.

Further

- (i) stockpile any excavated litter, topsoil and subsoils materials separately for later site rehabilitation;
- (ii) if scour is likely, ensure the bed is properly protected (see below);
- (iii) protect the opposite bank from scour as might be necessary, in consideration of the bank materials and the “jet” effect; and
- (iv) if salinity is an issue, ensure the pipe/culvert specifications conform to Australian standards.

12. Usually formed where the catch drains cross depressions or other waterways.

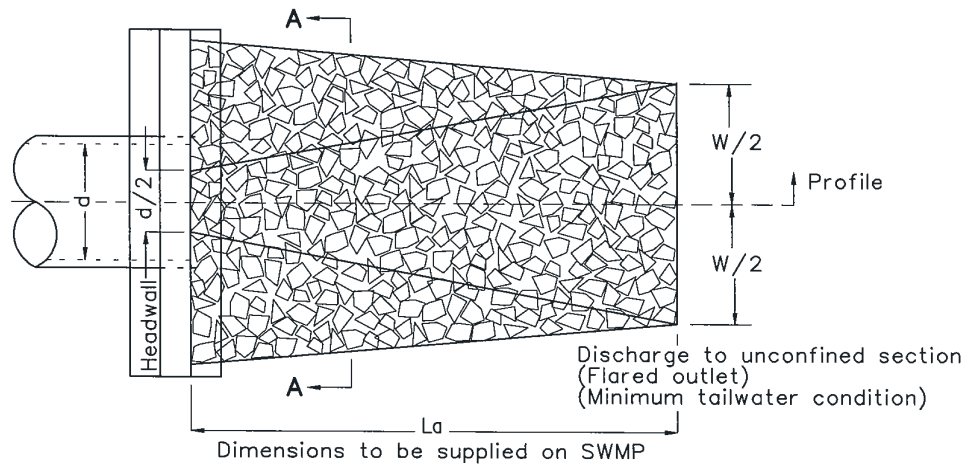
5. Erosion Control: Management of Water

- (d) Sometimes, upstream control works can reduce velocities at stormwater outlets. This can have a positive effect by reducing the sizes of energy dissipaters below.
- (e) Design criteria for energy dissipaters (Standard Drawing 5-8) should ensure:
- downslope conditions post development are not less stable than those prevailing predevelopment up to the design storm event (Section 2.3.1 (e))
 - minimum maintenance requirements, preferably self-cleaning natures
 - drainage by gravity when not in operation.
- (f) Energy dissipaters can be categorised into groups where energy is either absorbed by impact through an obstruction in the flow path, and/or dissipated through a hydraulic jump in a large stilling pool. Riprap aprons at the outlet of a pipe or culvert of diameter D , should be at least 300 mm deep, $3D$ wide at the pipe end, underlain by needle-punched geotextile, and constructed according to the following:
- (i) Decide whether minimum or maximum tailwater conditions apply using Q_{peak} in the receiving channel;^[13]
 - (ii) Enter the appropriate chart (figures 5.9 and 5.10) to find riprap size and apron length; and
 - (iii) Where both minimum and maximum tailwater conditions apply, design the apron to cover both conditions (figure 5.11).
- (g) Stabilise lands at and beyond outlets with a protective ground cover (Chapter 7). Within watercourses, ensure all rocks and cobbles in any permanent structures are packed with topsoil and planted with local native grasses, sedges and rushes. In disturbed areas in riparian zones (e.g. spoil areas, access tracks, etc.), plant local native shrubs, trees and groundcover species. Ensure these matters are properly addressed in a separate *Vegetation Management Plan* (Appendix I).

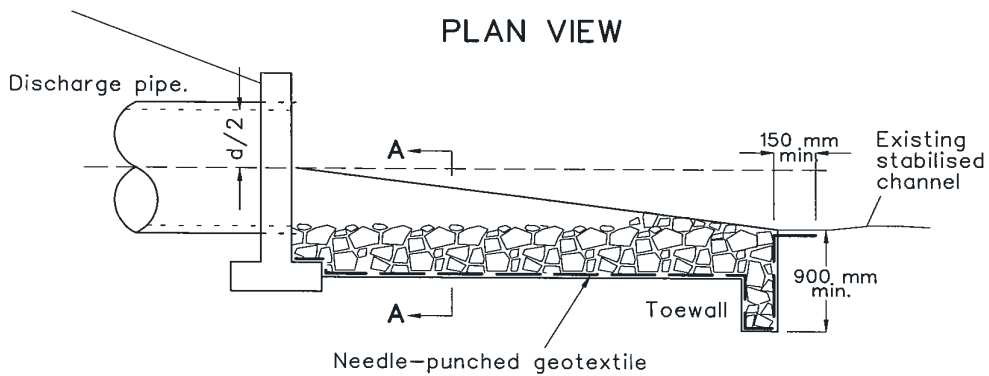
5.4.6 Subsoil Drainage

- (a) Subsoil drains provide a means for controlled flow of water through the soil. They must be designed and installed only after any salinity issues have been addressed fully. Types of subsoil drains include:
- (i) strip drains, comprising geotextile filters over non corroding, rot-proof, plastic cores;
 - (ii) rubble drains; and
 - (iii) perforated or slotted pipes.

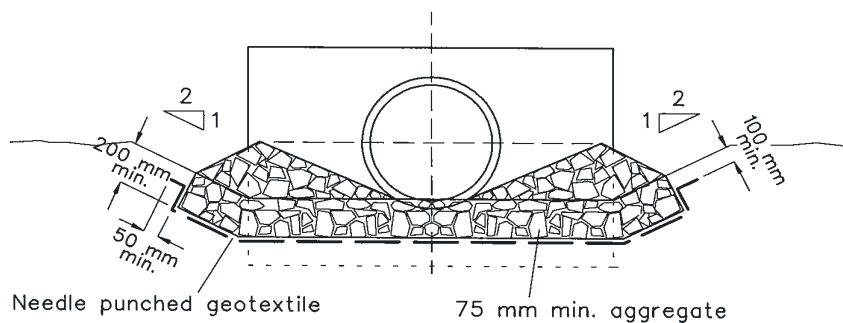
13. Calculate the depth of flow in the receiving channel and compare with the pipe diameter (D_o) – minimum tail water conditions are $<0.5D_o$, while maximum conditions are $>0.5D_o$. Note that:
– Where a well-defined channel does not occur, minimum tail water conditions apply and the width of the downstream end of the apron should be equal to the pipe diameter plus the length of the apron
– Where a well-defined channel occurs immediately downstream, the width of the downstream end of the apron should be equal to the width of that channel.



PLAN VIEW



PLAN VIEW



CROSS SECTION AA

Construction Notes

1. Compact the subgrade fill to the density of the surrounding undisturbed material.
2. Prepare a smooth, even foundation for the structure that will ensure that the needle-punched geotextile does not sustain serious damage when covered with rock.
3. Should any minor damage to the geotextile occur, repair it before spreading any aggregate. For repairs, patch one piece of fabric over the damage, making sure that all joints and patches overlap more than 300 mm.
4. Lay rock following the drawing, according to Table 5.2 of Landcom (2004) and with a minimum diameter of 75 mm.
5. Ensure that any concrete or riprap used for the energy dissipater or the outlet protection conforms to the grading limits specified on the SWMP.

ENERGY DISSIPATER

SD 5-8

5. Erosion Control: Management of Water

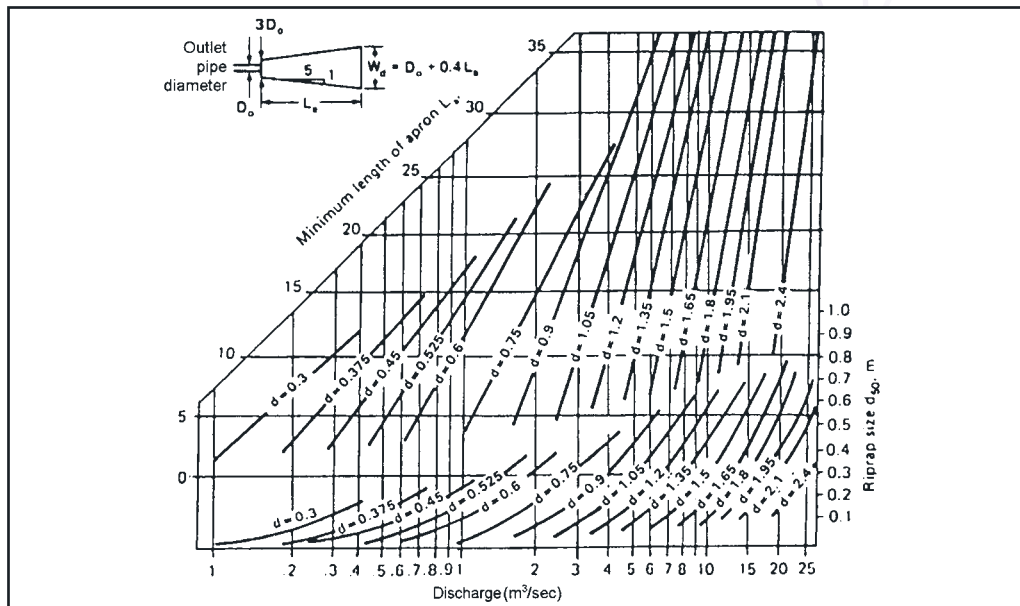


Figure 5.9 Design of riprap outlet protection - maximum tailwater conditions apply (MWRA, 1983)

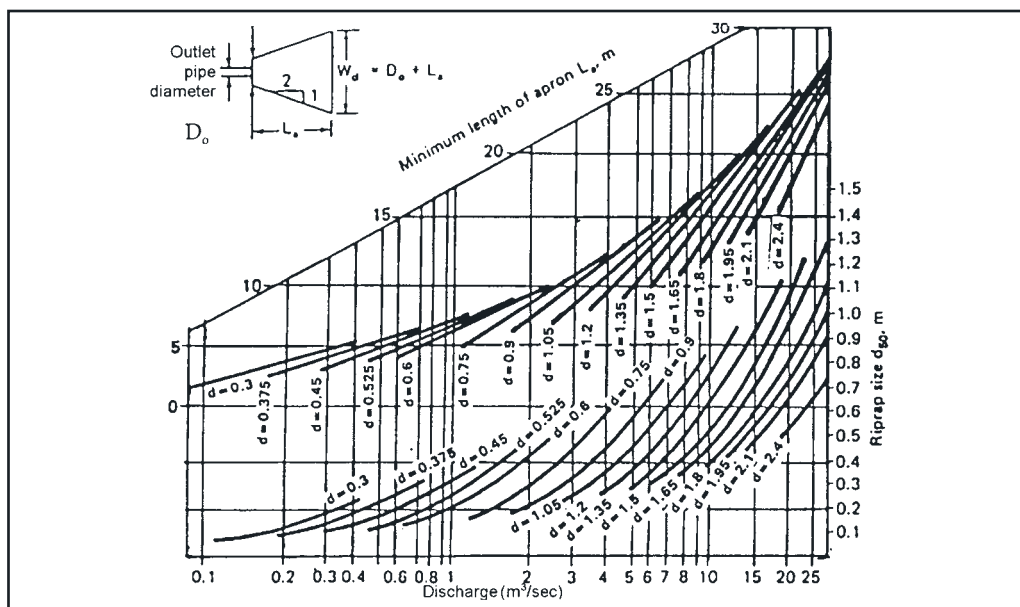


Figure 5.10 Design of riprap outlet protection - minimum tailwater conditions (MWRA, 1983)

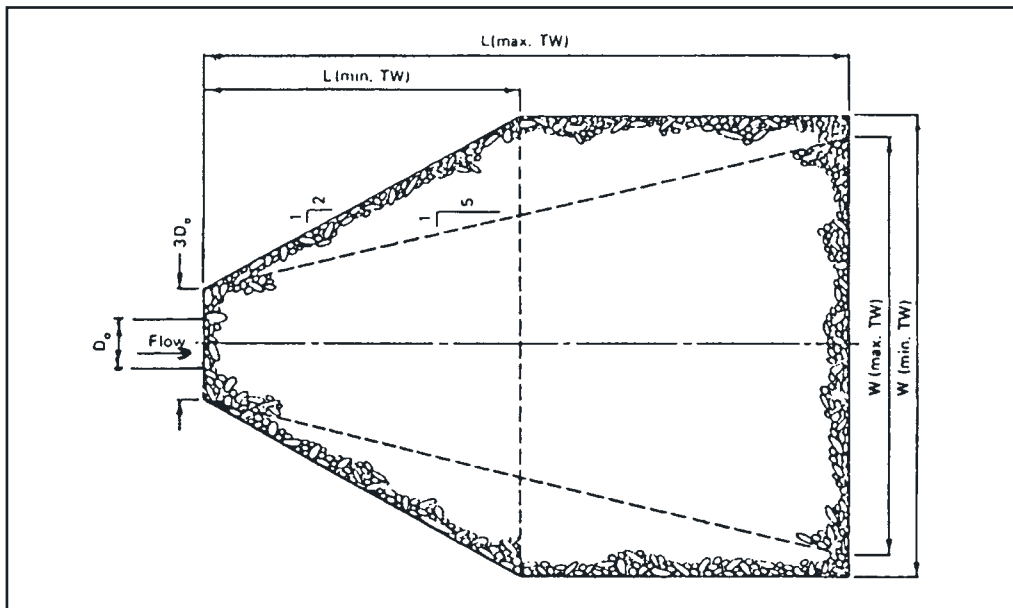


Figure 5.11 Riprap configuration for outlet protection under both maximum and minimum tailwater conditions (Bohan, 1970)

- (b) Subsoil drainage can be installed to:
- (i) improve the soil environment for vegetative growth by regulating ground water flow, especially in grassed waterways and other low lying areas, recreation areas (such as ovals), and dry detention basins; and
 - (ii) provide drainage of ground water on steep slopes to improve stability.
- (c) Line rubble drains and perforated pipes with geotextile to act as both filters and separators. This is critical where permanence is required and the subgrade is finer than 0.02 mm and/or more than 10 percent of the whole soil material consists of dispersible fines (Section 6.3.3 (c) and following sections).
- (d) When rubble drains or slotted pipes are used, they should be:
- (i) placed at a horizontal spacing that is consistent with the soil permeability and the desired surface amenity. As a general guide, place slotted pipes at a minimum depth of 0.6 metres below the soil surface while extending rubble drains to a depth of at least 0.6 metres; and
 - (ii) ideally, designed to provide a minimum gradient of 1 percent.



Chapter 6
SEDIMENT AND
WASTE CONTROL

6. Sediment and Waste Control

6.1 Introduction

6.1.1 Background

- (a) This chapter has been written as an aid to professional designers to allow for better consideration of sediment pollution from disturbed lands such as urban construction sites, mining sites and the like. As with the rest of these guidelines, though, it does not consider farming lands. While the chapter's main focus is the control of erosion of soils and pollution from sediment and waste during the land disturbance phase, very brief discussion is also provided for long-term pollution control where this is appropriate.
- (b) Stormwater treatment measures installed after construction is completed are not highlighted in this chapter. Specific information on this topic can be found in *Managing Urban Stormwater: Treatment Techniques* (EPA, 1997b; DEC, in prep.) and relating to such matters as:
- swales and "bioretention" measures
 - infiltration measures
 - constructed wetlands
 - gross pollutant traps and trash racks
 - litter baskets and litter booms
 - oil/grit separators
 - other treatment measures.

Additional information on constructed wetlands is provided by *The Constructed Wetlands Manual* (DLWC, 1998).

- (c) Stormwater runoff from disturbed lands has become a major source of pollutants in New South Wales' waterways, particularly as some of the more marginal urban lands have been developed around Sydney, Newcastle and Wollongong. This chapter concentrates on diffuse or non point source pollution from land development activity.
- (d) The form that diffuse pollution takes is usually determined by:
- climate, particularly local rainfall patterns
 - geomorphic aspects and soil characteristics of the source area
 - human and other activities in the catchment.

Contaminants are mainly transported by wind, rainfall or overland flow. Overland flow is especially relevant in areas with unprotected land surfaces or associated with particles that have settled on impervious surfaces.

- (e) The quality of runoff also depends on the stage of works. For example:
- (i) where much of the catchment lacks a suitable protective ground cover while development is going on, a potential exists for significant soil erosion of any exposed surfaces; and

-
- (ii) where a significant proportion of the catchment has been developed and rates of runoff are high due to many impervious areas, a potential exists for pollution to downslope lands and waterways by nutrients, heavy metals, various chemicals and the like.

6.1.2 Pollutants

- (a) The pollutants discussed and/or referred to in this document include:
- (i) suspended solids, especially sediment, that might carry nutrients “piggyback” and reduce:
 - light penetration in water and affect growth of aquatic plants
 - suitability of habitats for some aquatic flora and fauna
 - the aesthetic appeal of water;
 - (ii) nutrients that can promote the rapid growth of aquatic plants, particularly algae. Where algal growth becomes too dense:
 - reduction occurs in light penetration of water
 - oxygen levels of water can drop (see (iii), below)
 - suitability for recreation, irrigation, etc. diminishes, particularly if toxic algae are present;
 - (iii) oxygen-demanding materials that deplete levels of dissolved oxygen in the water causing conditions to become anaerobic and, in turn, resulting in either decay or death of submerged plants and other benthic (bottom-dwelling) organisms.^[1] These materials are usually measured in water as biochemical oxygen demand (BOD), and include biodegradable organic debris, such as decomposing litter and vegetation;
 - (iv) litter that is commonly washed from pavements and can be at high levels, especially in “first flush” waters; and
 - (v) microorganisms that frequently occur at high levels, especially in urban runoff, and associated with sewage/septic outfalls, animal faeces, soil, decaying vegetation and putrescible matter. Microorganisms that might make the water unsuitable for swimming or drinking are not discussed further here.
- (b) Two features of sediment pollution are:
- (i) studies at Lake Illawarra show that, where associated with new urban development for example, sediment pollution levels can be five to 20 times greater than those from developed urban areas and three to five times greater than those from undisturbed bushland; and

1. This situation often occurs when the available oxygen is used up by microorganisms that help in the decay process when plant materials die or an influx of other organic matter occurs. Various pollutants stored in sediment can be released under these conditions including phosphorus and some heavy metals. Some of these pollutants can promote further algal growth and a cycle is formed that is difficult to break.

6. Sediment and Waste Control

- (ii) many pollutants such as nutrients, are absorbed on and transported by suspended sediment particles, especially the finer (<0.005 mm) colloidal materials. Relatively coarse particles (>0.02 mm) hold very few pollutants.



Figure 6.1 Sediment deposition below a housing construction site. As a result, the bitumen road and kerb and gutter are barely distinguishable – only a drop inlet is clearly visible



Figure 6.2 Sediment resulting from unsatisfactory rehabilitation following roadworks

6.1.3 General Recommendations

- (a) Where it is an option, erosion and sediment control at land development sites is the least expensive and the single most effective way to reduce water-borne pollution. It should be regarded as a major priority.
- (b) Works should not cause either new seepage areas through rises in the watertable or pollution of aquifers.^[2]
- (c) Some aspects of sediment and nutrient management structures should not be deliberately combined, e.g. nutrient removal ponds (e.g. wetlands) should not be required to play a major role in removal of sediment. Nevertheless, each of these structures should be expected to remove various pollutants, but with varying degrees of effectiveness and with implications for design. However, nutrient removal ponds can be used for temporary sediment control during the construction phase when few nutrients are generated.
- (d) The approach should be implemented completely to ensure that the desired degree of soil and water management is achieved. To be effective, it should address control/mitigation of pollution of suspended solids through reduction of soil erosion and minimisation of sediment pollution using:
 - (i) drainage systems designed to minimise both the quantity of flow and its velocity, especially on unprotected land surfaces; and
 - (ii) system controls that reduce the quantity of suspended solids reaching receiving waters, such as sediment retention basins, sediment traps and constructed wetlands.
- (e) Be pragmatic in application of design criteria. Lower standards might be negotiable if the location and design of a particular structure meet a significant majority (e.g. >90%) of requirements and costs for the remaining parts are excessively high (in terms of capital and/or increasing the erosion hazard elsewhere). However, approval for any lower standards should be sought first with the consent authority. It is expected that application of lower standards will:
 - (i) be offset through application of more stringent erosion controls, i.e. modification to BMPs elsewhere; and
 - (ii) ensure that the viability of ecosystems downslope and aesthetic values are not compromised.

2. Rises in watertables through poor stormwater management practices are never encouraged and, especially, where the soils tend to have saline ground water. Many examples exist in New South Wales where extensive land degradation and damage to works have occurred because of what is now known as dryland salinity. While the principles of water sensitive urban design are strongly supported, the implications of encouraging water to infiltrate the ground should be thoroughly investigated always.

6. Sediment and Waste Control

- (f) Construct temporary works for control of pollution to be stable in runoff from the design storm event, usually taken to be the 10-year ARI time of concentration event. Design should take into consideration the implications of larger storm events and emergency spillways should be constructed where appropriate.

6.2 Waste Control

- (a) Safe management of waste materials, such as paint, concrete slurry, acid, toilet effluent, cleared vegetation, garbage and various chemicals, should be applied at all land disturbance sites. The Protection of the Environment Operations Act, 1997 makes it an offence to allow any of the above materials to leak, spill or escape from the site or to place it where it might harm the environment.
- (b) The following waste management practices should be applied:
- (i) If possible at the design stage:
 - design to standard sizes
 - specify recycled and recyclable products
 - specify reusable, repairable materials and fittings
 - renovate or refurbish, rather than rebuild
 - incorporate a composting area into the landscape design.
 - (ii) If practical during the demolition/extraction phase:
 - separate reusable materials for reuse on or off site
 - sell reusable materials to second-hand dealers
 - reuse rock, topsoil and vegetation on the site
 - stockpile materials for use elsewhere.
 - (iii) If practical during the construction phase:
 - reuse materials from the demolition/extraction phase
 - mulch and reuse as much green waste as you can
 - order materials to size
 - do not over order
 - order precut or prefabricated materials
 - purchase materials with minimal packaging
 - separate reusable or recyclable materials from waste
 - look out for and participate in recycling opportunities
 - organise onsite sorting and/or collection systems for reprocessing
 - train site workers not to damage or contaminate materials or off cuts so they can be reused elsewhere.
 - (iv) Store all possible pollutant materials well clear of any poorly drained areas, flood-prone areas, streambanks, channels and stormwater drainage areas. Such materials should be stored in a designated area, under cover where possible. Containment bunds should be constructed with provision for collection and restorage of any spilt material.

-
- (v) Wash down materials and equipment away from the foreshore and intertidal areas.
 - (vi) Waste receptacles should also be placed away from the foreshore and intertidal areas. Where this is impractical, they can be placed there providing they are not overloaded and are watertight. Further, they should be provided with suitable waterproof covers for use during rain and site shutdown (e.g. weekends and nights) to prevent entry of water and vermin, and litter being blown around the area.
 - (vii) Ensure that runoff from polluted hard surfaces like roadways and vehicle hard stand areas is properly treated before discharge to the stormwater system.
 - (viii) Place staff facilities so that any effluent, including wash-down water, can be totally contained and treated within the site management area. Inform staff of the nature of each facility and of their obligation to use them.
 - (ix) For vegetation:
 - preferably reuse waste materials onsite by chipping, mulching or composting, particularly where they can be used in rehabilitation programs
 - otherwise:
 - gain necessary approvals from the local consent authority to remove it to an approved landfill; or
 - gain necessary approvals from the local council before burning waste in the open or by trench burning.
 - (x) Shift sorted waste only in an approved manner by means of suitable transport to licensed landfill sites.
 - (xi) Clear any bins of concrete and mortar slurries, paints, acid washings, light-weight waste materials and litter at least weekly or more frequently if they fill.
 - (xii) Provide designated waste collection areas with appropriate bunds or containers and maintain waste disposal and collection systems to operate within their capacity.
 - (xiii) Be careful in the disposal of used chemical containers and in the management of runoff and sediment loss from areas treated with pesticides (where possible use less hazardous or alternate material and comply with manufacturer's safety/usage directions).
 - (xiv) Dewatering activities should be closely monitored to prevent pollution in the form of sediment, toxic materials or petroleum products. Sediment controls should be established and testing of ground water should be undertaken before commencement of dewatering activities.
 - (xv) Prevent the discharge of pollutants to stormwater because of vehicle and equipment maintenance. This can involve using offsite maintenance facilities or undertaking work in designated and bunded areas only. Regular checks

6. Sediment and Waste Control

should be undertaken to ensure leaks and spills are rectified and cleaned immediately. Employees and subcontractors should be trained in this regard.

(xvi) Dispose of waste to landfill only as a last resort. Landfill sites and waste transfer stations will:

- require correct handling for dusty or hazardous wastes
- impose price penalties for mixed loads
- offer discounts for sorted wastes, such as bricks, metals and timber.

(xvii) Depending on the size of the job, the local council might require a waste management and minimisation plan. This will set out the type and volumes of any waste materials generated on the job, and explain reuse, recycle and disposal processes.

6.3 Sediment Control

6.3.1 Preamble

- (a) Sediment retention basins are dams or impoundments designed to intercept sediment-laden runoff and retain most sediment and other materials, thereby protecting downstream waterways from pollution. The retention is generally achieved by the settling of the suspended sediment from the stormwater flow, combined with the interception of bedload material.
- (b) Like other measures employed to control erosion and sediment at construction sites, sediment basins should be regarded as one component (or “carriage”) in a properly planned “treatment train” (Section 1.2(b) (ii)). As previously stated, the control of soil erosion is the best way of minimising sediment pollution of receiving waters, an especially important principle with fine-grained soils. Sediment basins should be regarded like a fullback in a football team – a final control to be used when all others fail. However, as all construction activities inevitably disturb or expose soil materials, sediment basins (together with filters and traps) are frequently an important component of soil and water management on disturbed lands. As with a fullback, they are an essential part of the team or treatment train.
- (c) The choice of sediment control measures is not limited to those nominated in this document. Creativity, combined with a sound understanding of the principles presented here, should allow other measures to be adopted to suit circumstances, provided those measures can be justified properly.
- (d) Be aware that current legislation requires that the quality of runoff water leaving any work site must be of an acceptable standard and that this legislation does not make allowance for:

-
- particular difficulty with the site
 - specific or general problems in carrying out the *ESCP/SWMP*
 - whether the site manager is familiar with site-work management.

6.3.2 General Recommendations

The following issues should be considered in relation to the control of sediment:

- (a) Design structures to minimise land disturbance.
- (b) Pass any potential sediment-laden stormwater runoff through a trap or basin designed to minimise pollution to lands, waterways and services placed further downslope. Keep sediment as close to its source as possible.
- (c) Where possible, do not construct sediment basins on line on a watercourse.
- (d) Some small and/or flat sites might not warrant construction of a sediment basin, including those for which an *ESCP* (rather than a *SWMP*) is required (<2,500 square metres disturbed area). If in doubt, the average annual soil loss from the total area of land disturbance can be estimated (Appendix A). Where this is less than 150 cubic metres per year, the building of a sediment retention basin can be considered unnecessary. In such circumstances, alternate measures may be employed to protect the receiving waters.
- (e) Design of sediment retention basins should ensure that water is not diverted from its intended flow path if structures become filled with sediment in the nominated storm event.
- (f) Where practical, place sediment control structures:
 - (i) so that only waters polluted because of site land disturbance activities enter them (i.e. waters from off-site sources and/or those from the site that are clean should be diverted elsewhere);
 - (ii) off-line, so that trunk drainage carries only relatively clean water;
 - (iii) away from normal construction operations (to minimise the need for regular repair); and
 - (iv) upstream of any wet ponds, constructed wetlands or receiving waters.^[3]
- (g) Soil erosion and any resultant sediment pollution are largely dependent on storm size and nature of the soils. Ensure that the design:

3. Here, "waters" mean:

- street gutters
- natural waterbodies, including lakes, lagoons or wetlands, rivers or streams, and tidal waters, e.g. bays, estuaries, inlets, etc.
- constructed waterbodies, including lakes, wetlands, dams, ponds, waterways, channels or canals.

6. Sediment and Waste Control

- (i) allows adequate time for settling of the desired particle sizes; and
 - (ii) has adequate capacity to trap and store sediment eroded from the site.
- (h) Where practical, do not decommission temporary sediment retention basins and traps until the works for which they were designed are completed and fully stabilised on more than 90 percent of the contributing catchment. Address the financial and other implications in the planning phase where this involves other developers or site operators.

6.3.3 Design of Sediment Basins

- (a) When designing sediment retention basins, two principal criteria should be considered at the outset – the structures must have an ability to meet:
- appropriate water quality standards – discussed further below
 - necessary structural integrity and stability standards.

Normally, sediment basins and their outlets should be designed to be stable in the peak flow from at least the 10-year ARI time of concentration event. However where individual circumstances dictate, adopting higher design standards for basin outlets might be necessary. Basins might need to be referred to the Dam Safety Committee if the wall is more than 15 metre high and/or failure could adversely affect the community's interests or the environment downstream. Further details on prescribed dams and surveillance requirements are at:

www.damsafety.nsw.gov.au/ftp/publications/pdf/dsc01.pdf.

- (b) The effective design and operation of sediment retention basins from a water quality perspective depends primarily on the nature of the soil materials likely to be eroded and washed into them. Protection of downstream lands and waterways demands an approach to basin design that recognises the settling behaviour of different soil particles in water. Clearly, coarse-grained sediment will settle quicker than finer-grained sediment, whereas some clay particles seemingly never settle unaided.
- (c) Soil materials that can erode and find their way to a sediment retention basin can be classified into three "texture" groups based on how effectively they are likely to settle:
- "Type D" soils that contain a significant proportion of fine (<0.005 mm) "dispersible" materials that will never settle unless flocculated^[4]

4. Not all particles finer than 0.005 mm are dispersible. Clays are complex laminated structures comprising alternating sheets of alumina and silica. Typical structural groupings based on silica to aluminium ratios are:

- 1:1 (kaolinite type) clays
- 2:1 low expansion (illite) clays
- 2:1 high expansion (montmorillonite, bentonite, smectite) clays.

The structural grouping of the clay minerals can influence important soil properties, e.g. cation exchange capacity, shrink/swell potential, fertility and dispersibility. Illite structures can become dispersible if deformed while wet while montmorillonite structures tend to be dispersible always.

-
- The other two categories cover those soils that are not dispersible:
- “Type C” soils, the bulk of which are coarse-grained (less than 33 percent finer than 0.02 mm) and will settle relatively quickly in a sediment retention basin
 - “Type F” soils, the bulk of which are fine grained (33 percent or more finer than 0.02 mm) and require a much longer “residence” time to settle in a sediment retention basin.
- (d) When deciding which soil type applies to a particular land disturbance activity, consider the following matters:
- (i) Where soils of more than one type are present at a specific site, sediment basins should be designed to meet the most stringent criterion applicable. In this, note that soils that are essentially coarse-grained can be *Type D*.
 - (ii) No matter whether soils are classified as *Type D*, *Type C* or *Type F*, ensuring that pollution does not occur to downslope receiving waters is essential. To this end, treated discharge waters should not contain more than 50 milligrams per litre of suspended solids in the design rainfall event. More stringent requirements might be necessary in particularly sensitive environments or, where applicable, can be required by Council’s stormwater management plan. Of course, all practical measures to reduce pollution should be taken for storm events beyond the design event.^[5]
- (e) Soils that are dispersible (*Type D*) and require flocculation (Appendix E) are those where more than 10 percent of the materials are dispersible. That is, where the percentage clay plus half the percentage silt (roughly the fraction <0.005 mm) multiplied by dispersion percentage (Ritchie, 1963) is equal to or greater than 10. ^[6]
- (f) A simple field test is available that can eliminate the need for laboratory testing for dispersibility. This is the “field” Emerson Aggregate Test and is described further at Appendix E. However, soils that fail this test are not necessarily dispersible to the extent that flocculation is obligatory and laboratory analysis of dispersion percentage might still be required.

5. The actual discharge load should be considerate of the loads normally carried in the receiving waters, including those during and following storm events. Any fluvial processes within these waters will have reached equilibrium considerate of those loads. Reducing them significantly below these levels can cause streams to become “hungry” and erode their own bed and banks; while increasing them significantly can result in degradation to ecosystems.

6. Hazelton and Murphy (1992) provide a means of using Soil Texture Class as a guide to particle size distribution. Note that:

- clays are finer than 0.002 mm (2 microns)
- silts range from 0.002 to 0.02 mm (2 to 20 microns)
- fine sands from 0.02 to 0.2 mm (20 to 200 microns)
- coarse sands from 0.2 to 2.0 mm (200 microns to 2.0 mm).

Most fine sands need a magnifying lens to see them.

6. Sediment and Waste Control

- (g) With dispersible and fine-grained soils, place far greater emphasis on erosion control measures to offset lower efficiencies achieved with sediment retention.
- (h) The actual capacity of sediment retention basins is the sum of two components (Table 6.1):
 - (i) A settling zone, within which water is stored allowing the settlement of suspended sediment. The settling zone is designed to capture most sediment in a nominated design rainfall event and, in turn, a specific discharge water quality.
 - (ii) A sediment storage zone, where deposited sediment is stored until the basin is cleaned out – or for the life of the project where land disturbance is of a short duration (<two months).
- (i) All sediment retention basins that might discharge sediment-laden stormwater more than once per year should have minimum length to width ratios of 3 to 1 to reduce short-circuiting and, preferably, at least 5 to 1. Figure 6.3 shows the influence of the ratio of the minimum flow-path length to the effective width on the apparent effectiveness of a sediment retention basin for one particular soil type. The actual effectiveness of a sediment retention basin must take into account its apparent effectiveness and the proportion of the design-size particles in the sediment load. Baffles can be employed to maximise the effective flow path within sediment basins as shown in figure 6.4.

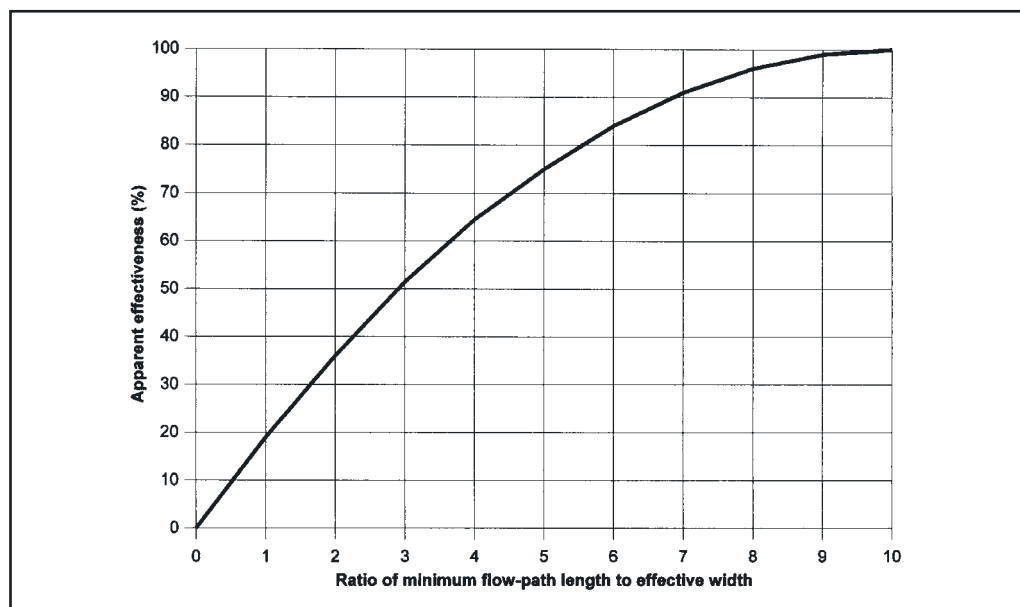


Figure 6.3 Apparent effectiveness of a sediment containment system (Fifield, 2001a)

Table 6.1 Summary of selected sediment basin types and design criteria

Soil Type	Soil characteristics	Treatment process	Basin design capacity	
			Settling zone	Sediment storage zone
Type D (dispersible)	10 percent or more of the soil materials are dispersible. Particle size is irrelevant	Aided flocculation in wet basins	Capacity to contain all runoff expected from the y percentile, x-day rainfall depth where, depending on the sensitivity of the receiving waters and/or the duration that the structure is in use: x is 2, 5, 10 or 20-days y is the 75th, 80th, 85th or 90th percentile	Normally taken as 50 percent of the capacity of the settling zone. However, it can be taken as two months soil loss as calculated by the RUSE
Type C (coarse)	Less than 33 percent finer than 0.02 mm and less than 10 percent of the soil materials are dispersible	Rapid settling in wet or dry basins	Surface area of 4,100 m ² /m ³ /sec in the 3-month ARI flow, minimum depth of 0.6m, and length:width ratio of >3:1	Normally taken as 100 percent of the capacity of the settling zone. However, it can be taken as two months soil loss as calculated by the RUSE
Type F (fine)	33 percent or more of the particles are finer than 0.02 mm and less than 10 percent of the soil materials are dispersible	Slow settling in wet basins	Capacity to contain all runoff expected from the y percentile, x-day rainfall depth where, depending on the sensitivity of the receiving waters and/or the duration that the structure is in use: x varies between 2 and 20 days y is the 75th, 80th, 85th or 90th percentile	Normally taken as 50 percent of the capacity of the settling zone. However, it can be taken as two months soil loss as calculated by the RUSE

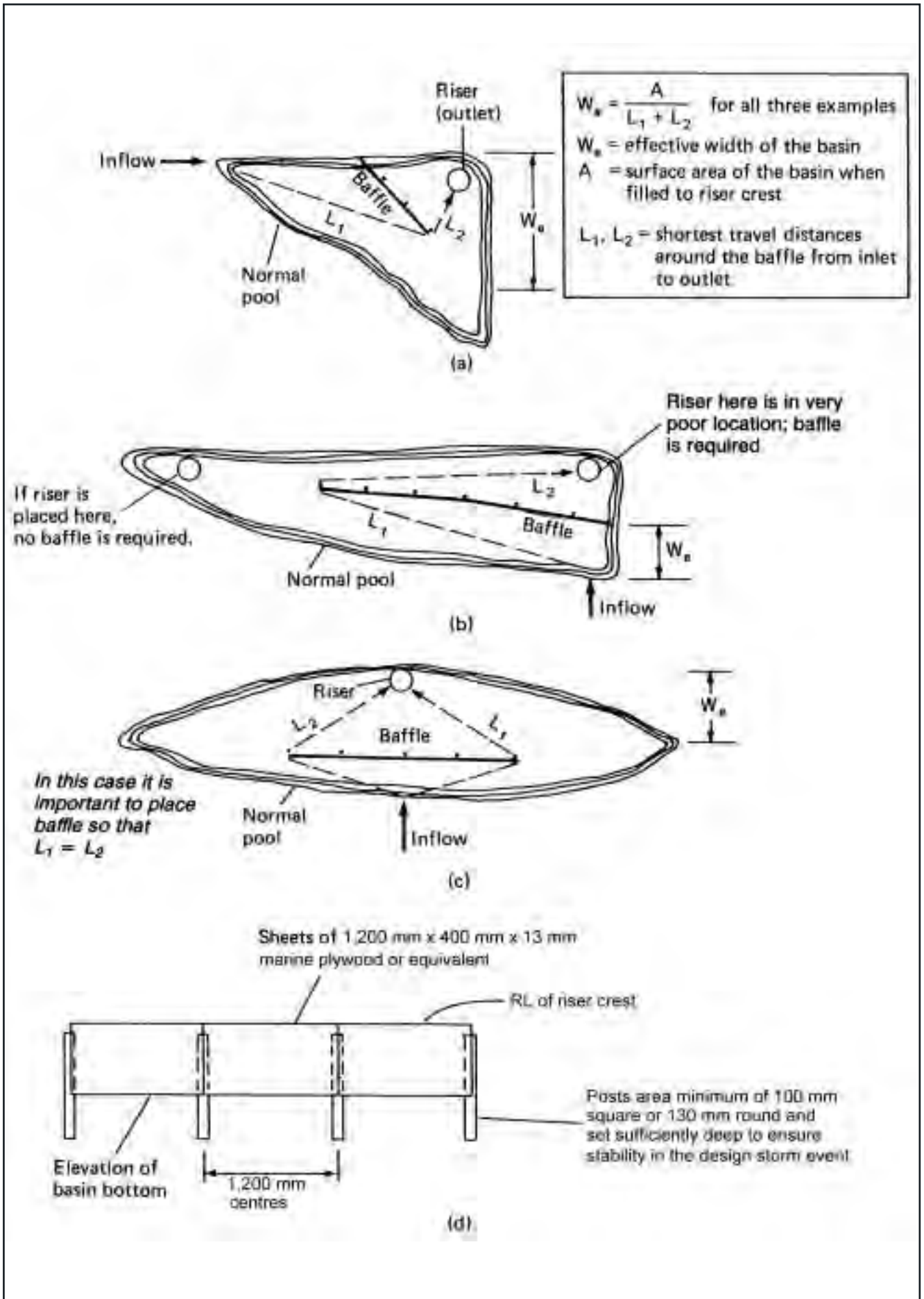


Figure 6.4 (a) to (c) – diagrammatic examples of placement of baffles in sediment basins to increase the ratio of length to width, and (d) – baffle detail, elevation (adapted from USDA, 1975)

-
- (j) Sediment retention basins should be built to incorporate:
- (i) a primary outlet designed:
 - to have a capacity to pass the peak flow from the design storm event
 - with an invert level at least 300 mm below any emergency outlet (where it is a separate structure);
 - (ii) an emergency spillway designed to have a capacity to pass the peak flow from the applicable storm event. Generally, this should be of open construction rather than a pipe outlet due to the risk of pipe blockages during high flows.^[7] Nevertheless, any riser structures should be baffled or fitted with anti vortex devices;
 - (iii) internal batter gradients that are consistent with personal safety and, generally, within the following upper limits:
 - where water depth is less than 150 mm when surcharging, 2.5(H):1(V) to 4(H):1(V) on earth structures and vertical on rock or gabion structures^[8]
 - where water depth is between 150 and 1,500 mm when unprotected and surcharging, a maximum slope of 5(H):1(V)^[9]
 - where water depth is between 150 and 1,500 mm when protected (e.g. fenced) and surcharging or greater than 1,500 mm:
 - 2.5(H):1(V) to 4(H):1(V) on earth structures^[8]
 - 0.5(H):1(V) on rock giber structures
 - 1(H):4(V) on gabion basket structures
 - 1(H):4(V) on stacked (rough squared) rock structures;
 - (iv) appropriate outlet protection to ensure minimisation of scour as described in Section 5.3.3.
- (k) Sediment basins can be constructed from earth, rock or suitable crushed concrete products where formed as aboveground ponds, or plastic or metal for underground tanks (see Standard Drawings SD 6-1, SD 6-2, SD 6-3, SD 6-4, SD 6-5). Choice of materials generally depends on constraints imposed by the design criteria, site conditions and local maintenance/cleaning criteria. Rock and gabion basket structures should be lined on the inside with a geotextile material (dry basins) to ensure removal of sediment particles from the system, or a suitable impermeable material for wet (*Type D* or *Type F*) basins.^[10]

7. If a piped outlet is adopted as an emergency spillway, appropriate measures should be employed to minimise the risk of blockages, and/or the pipe outlet should be significantly over designed to reduce the risk of blockage.

8. The actual gradient adopted depends on various soil characteristics.

9. The actual maximum gradient is determined by the "slipperiness" of the saturated sediment – whether or not a person can achieve a firm footing on it. Slippery sediments should have less steep gradients, in the order of 8:1 or even 10:1.

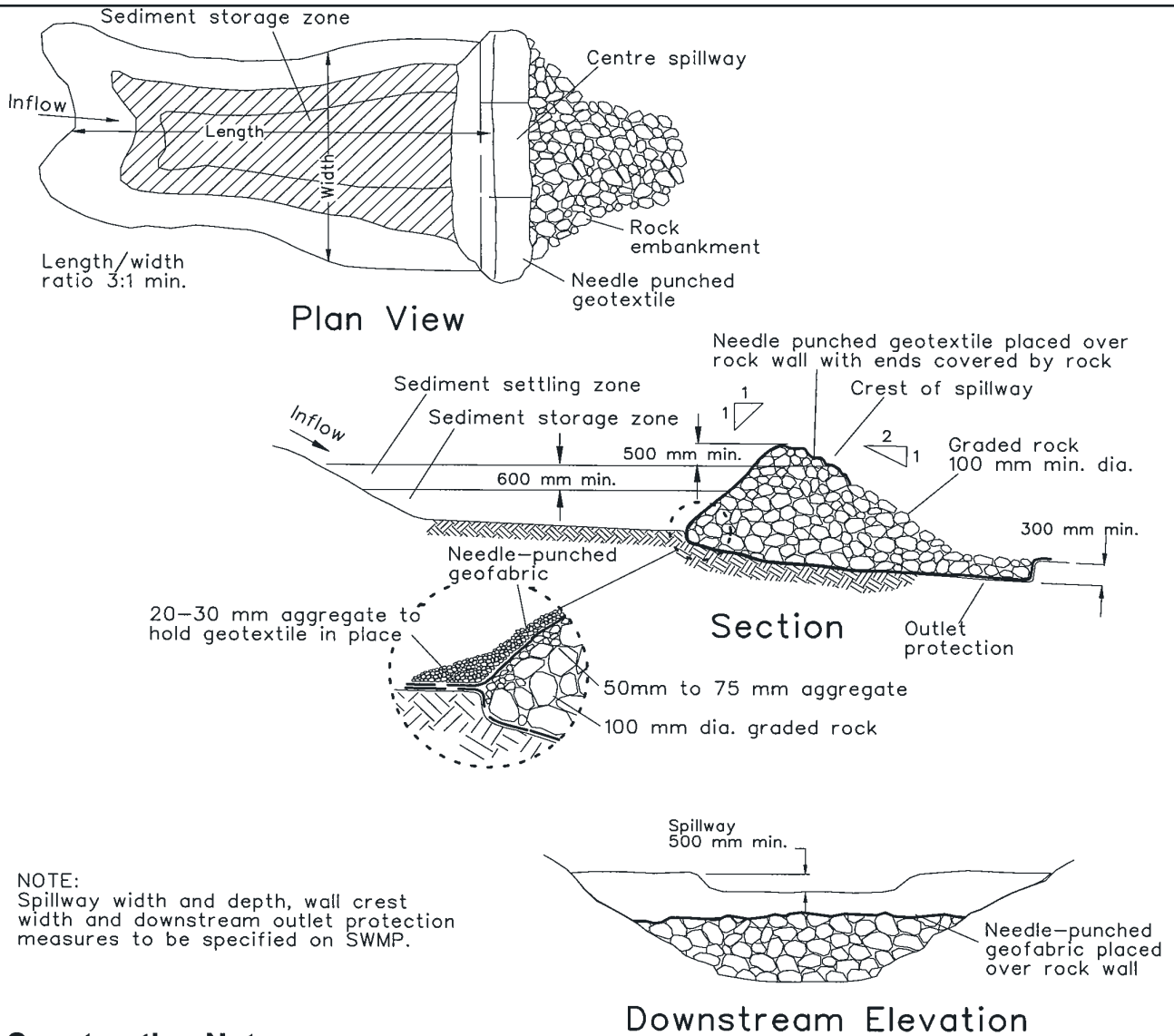
10. Geotextile can become blocked in time. So, dry basins can become wet if it is not replaced or reverse-flushed.

6. Sediment and Waste Control

- (l) The lower level of the settling zone should be identified with a peg or other marker that shows clearly the level above which the design capacity is available. Stored sediment should not encroach into the settling zone.
- (m) Sediment removed from sediment basins should be disposed in places that will not result in a future erosion or pollution hazard (see Section 4.3.2 (h)). Note that fine and/or flocculated sediment removed from wet basins might require considerable time to dry to a level where it can be handled with relative ease.

6.3.4 Capacity of Basins for *Type D* and *Type F* Soils

- (a) Sediment retention basins for *Type D* and *Type F* soils are wet basins (SD 6-4 and SD 6-5). Their design criteria are the same. They differ only in management and, specifically, the recommended methods of dewatering and in the likely use of flocculants.
- (b) The traditional approach to design of sediment retention basins is based on the settling of a design particle. However, this settling methodology is generally ineffective where the sediment contains significant quantities of fine (<0.02 mm) or dispersible materials because of very long settling times that require extraordinarily large structures and, even then, might not achieve the desired result. Both *Type D* and *Type F* soils are very fine and *Type D* soils are dispersible as well. So, generally, a total storm containment system is adopted here for a nominated design rainfall depth, a risk-based approach that is considerate of local daily rainfall patterns. Such basins are normally empty. They fill after rainfall events with water remaining in them long enough to be properly treated with settling agents such as gypsum (Appendix E). They are then pumped out or allowed to drain under gravity.
- (c) However, other methodologies are available that enable constant flocculation of sediment-laden waters derived from *Type D* soils. One such method is described at Section E4.2 (Appendix E). Such basins do not require pumping out, so long as they can achieve an acceptable suspended solid's concentration of less than 50 milligrams per litre in the residence time provided in the design storm. Use of such alternative approaches should not vary the design capacity from that described here.
- (d) A 5-day rainfall depth can be adopted as standard in the design of the settling zone where the soils being disturbed are *Type D* or *Type F*. This assumes that five days or less are required following a rainfall event to achieve effective flocculation if necessary, settling and subsequent discharge of the supernatant stormwater (Appendix E and Section 6.3.3(d)).
- (e) In certain conditions, basins can be designed for rainfall depths and management periods of between 2 and 20 days, to accommodate a range of site constraints and opportunities that may be present :



NOTE:
 Spillway width and depth, wall crest width and downstream outlet protection measures to be specified on SWMP.

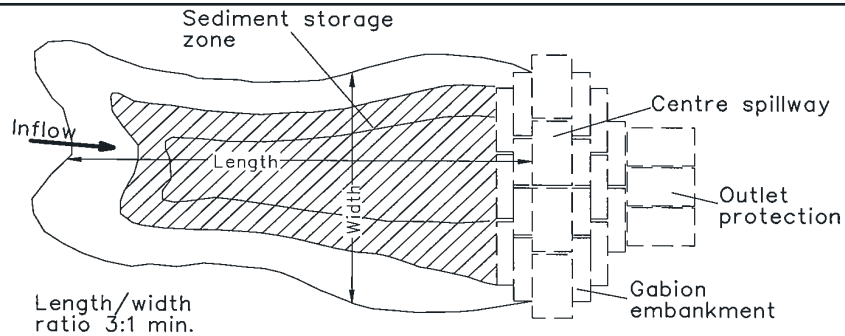
Construction Notes

1. Remove all vegetation and topsoil from under the dam wall and from within the storage area.
2. Excavate to 300 mm depth for base of the dam wall.
3. Line the excavation with a needle-punched geotextile allowing sufficient to line below the wall, and over the upstream rock and the spillway to 500 mm below the spillway exit on the downstream face.
4. Make up the wall profile and outlet protection with 100 mm (min.) diameter graded rock. Spread a layer of 50 mm to 75 mm diameter aggregate over the upstream batter for a more even surface, and add 100 mm to 150 mm of 20 mm to 30 mm gravel over the 50 mm to 75 mm diameter aggregate.
5. Lay geotextile over the upstream batter and through the spillway, fixing in place with 100 mm rock.
6. Place a "Full of Sediment" marker to show when less than design capacity occurs and sediment removal is required.
7. Replace the upstream geotextile layer each time sediment is removed

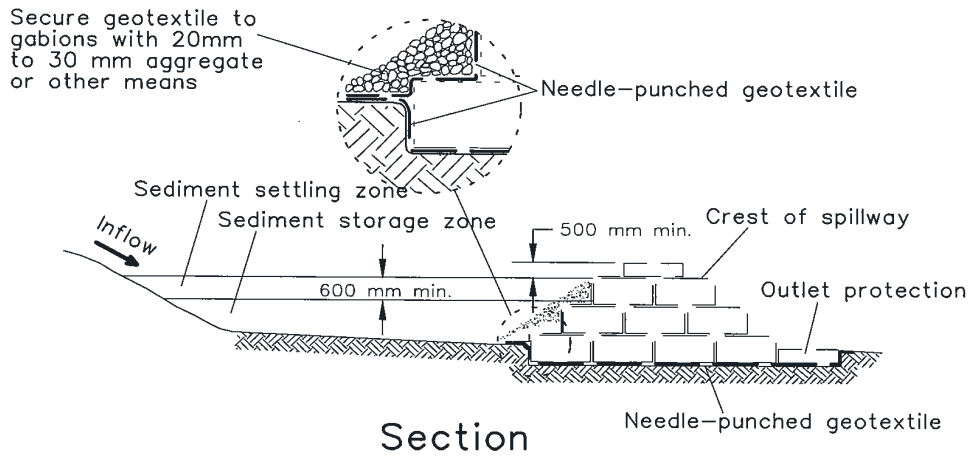
ROCK SEDIMENT BASIN

(APPLIES TO 'TYPE C' SOILS ONLY)

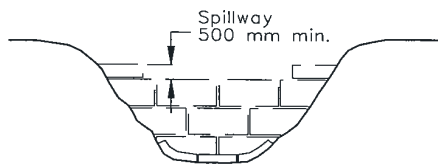
SD 6-1



Plan View



Section



Downstream Elevation

NOTE: Spillway width and depth, wall crest width and downstream outlet protection measures to be specified on SWMP.

Construction Notes

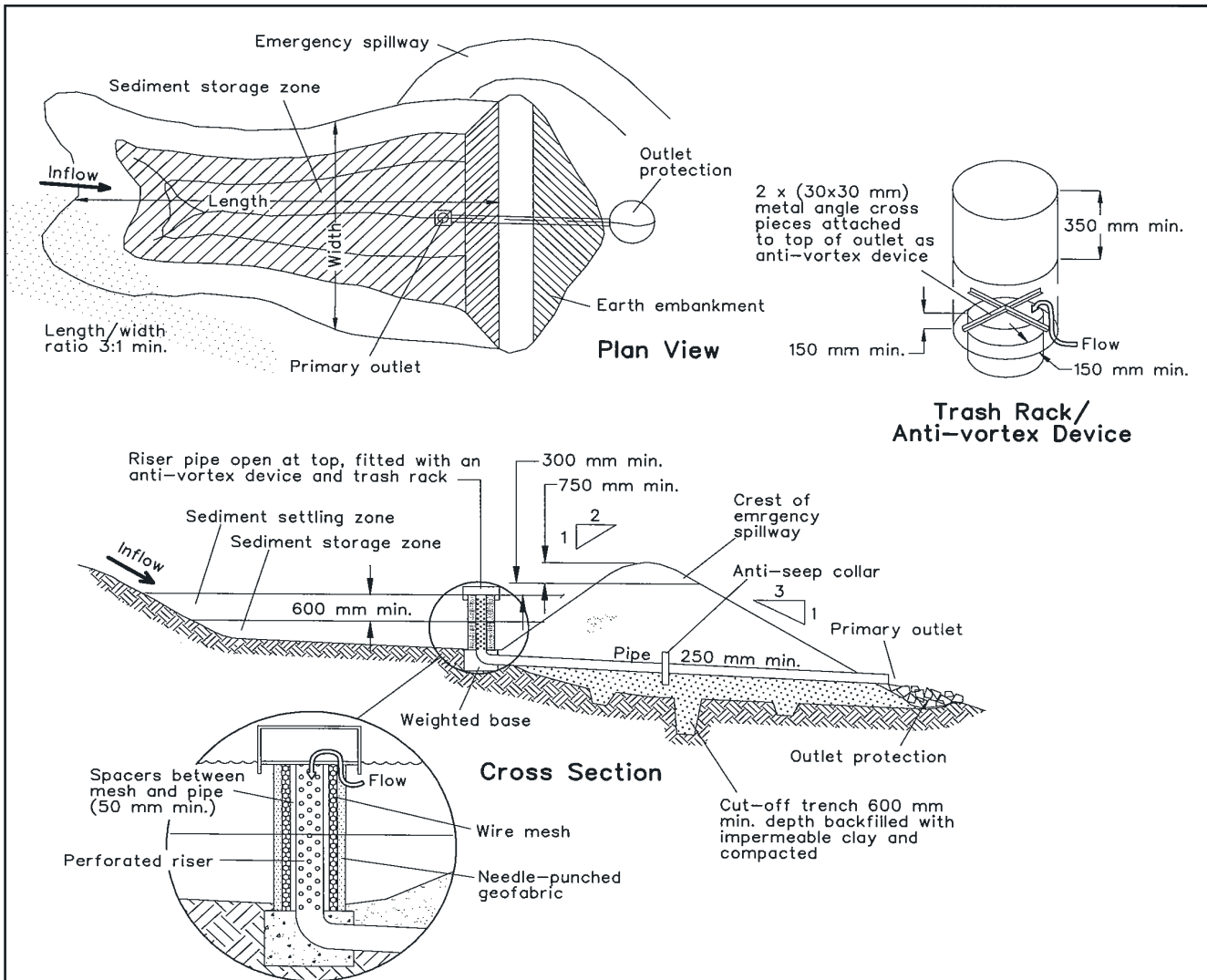
(Applies to Type C soils only)

1. Remove all vegetation and topsoil from under the dam wall and from within the storage area.
2. Excavate to 300 mm depth for the base of the dam wall and form a level platform for the gabions.
3. Line the excavation with a needle-punched geotextile allowing sufficient to line below the wall, and over the upstream gabions and spillway to 500 mm below the spillway exit on the downstream face.
4. Make up the wall profile and outlet protection with gabion units filled with graded rock as specified on the SWMP.
5. Construct a spillway 500 mm below the crest of the dam and for the width specified on the SWMP.
6. Lap the geotextile over the upstream face and through the spillway and fix it in place with the top row of gabions.
7. Cover the upstream face of the wall with 20 mm to 30 mm gravel and geotextile (Standard Drawing 6-2b)
8. Place a "Full of Sediment" marker to show when less than design capacity occurs and sediment removal is required.
9. Replace the upstream geotextile layer when sediment is removed if a dry basin is required.

GABION SEDIMENT BASIN

(APPLIES TO 'TYPE C' SOILS ONLY)

SD 6-2

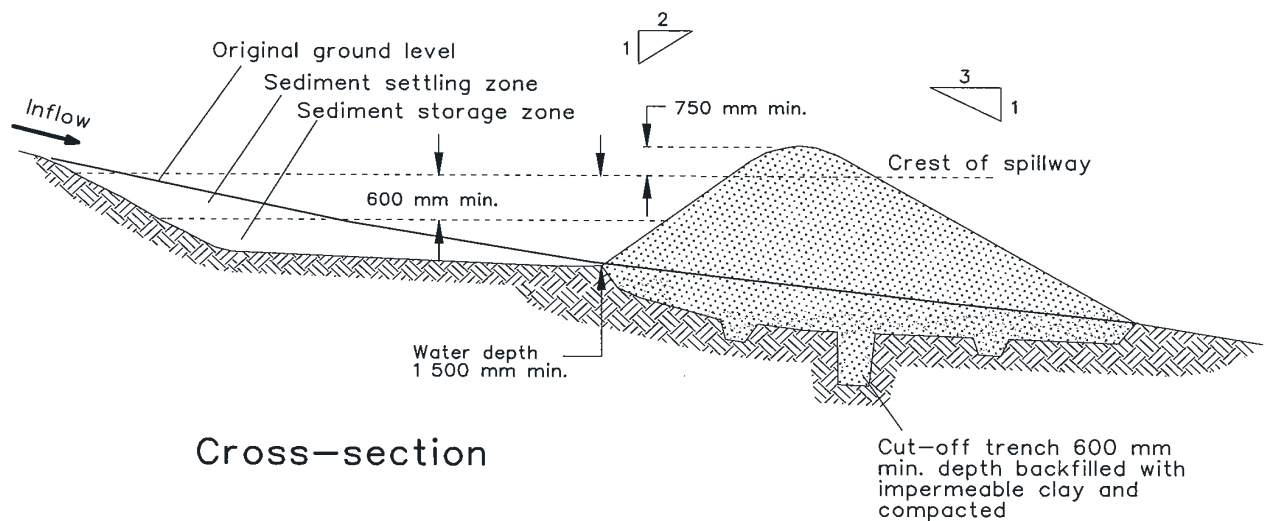
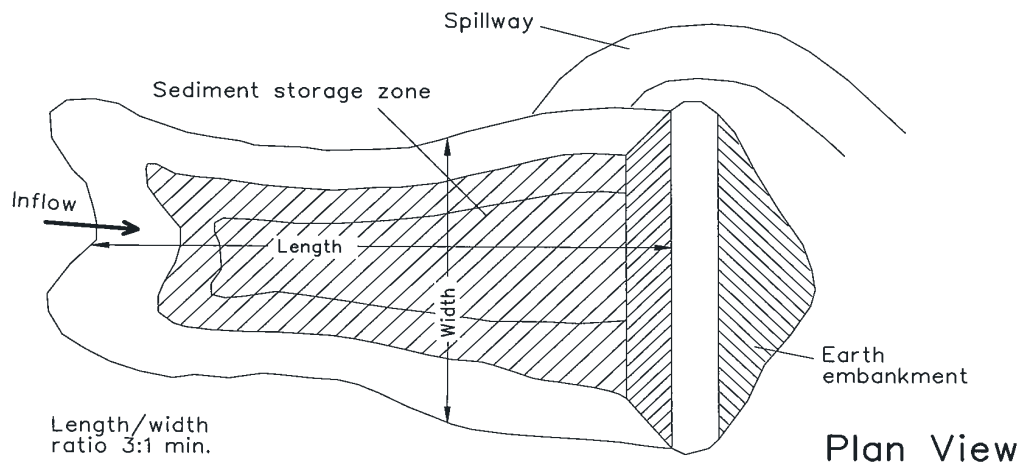


Construction Notes

1. Remove all vegetation and topsoil from under the dam wall and from within the storage area.
2. Form a cut off trench under the centreline of the embankment 600 mm deep and 1,200 mm wide, extending to a point on the watercourse wall above the riser sill level.
3. Maintain the trench free of water and recompact the materials with equipment as specified in the SWMP to 95 per cent Standard Proctor Density.
4. Select fill according to the SWMP that is free from roots, wood, rock, large stone or foreign material.
5. Prepare the site under the embankment by ripping to at least 100 mm to help bond the compacted fill to the existing substrate.
6. Spread the fill in 100 mm to 150 mm layers and compact it at optimum moisture content following the SWMP.
7. Install the pipe outlet with seepage collars as specified in the SWMP and Standard Drawing 6-3b.
8. Form batter grades at 2(H):1(V) upstream and 3(H):1(V) downstream or as specified in the SWMP

EARTH BASIN - DRY
(APPLIES TO 'TYPE C' SOILS ONLY)

SD 6-3

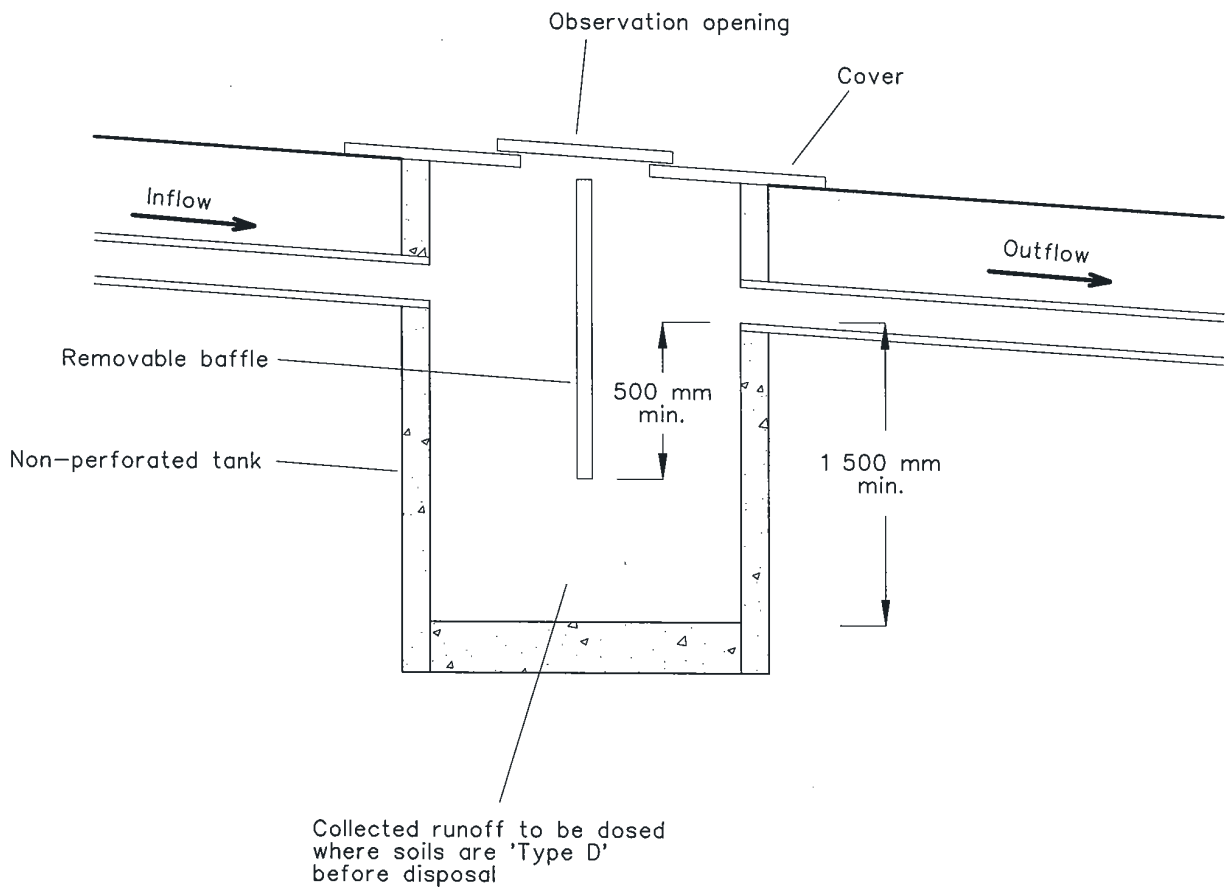


Construction Notes

1. Remove all vegetation and topsoil from under the dam wall and from within the storage area.
2. Construct a cut-off trench 500 mm deep and 1,200 mm wide along the centreline of the embankment extending to a point on the gully wall level with the riser crest.
3. Maintain the trench free of water and recompact the materials with equipment as specified in the SWMP to 95 per cent Standard Proctor Density.
4. Select fill following the SWMP that is free of roots, wood, rock, large stone or foreign material.
5. Prepare the site under the embankment by ripping to at least 100 mm to help bond compacted fill to the existing substrate.
6. Spread the fill in 100 mm to 150 mm layers and compact it at optimum moisture content following the SWMP.
7. Construct the emergency spillway.
8. Rehabilitate the structure following the SWMP.

EARTH BASIN - WET
(APPLIES TO 'TYPE D' AND 'TYPE F' SOILS ONLY)

SD 6-4



Construction Notes

1. Join the inlet to the stormwater, taking any suitable steps to remove bulky or coarse material before it can enter the tank.
2. Connect the outlet to a safe disposal area following the SWMP.
3. Install a removable baffle, central to the inflow/outflow and normal to the direction of flow, ensuring that it reaches 500 mm below the invert of the outlet pipe.
4. Install a cover over the pit with an observation port and access cover.

LINED TANK

SD 6-5

6. Sediment and Waste Control

- (i) Where the site area is insufficient to allow building structures as required for the y-percentile 5-day criterion, a 2, 3 or 4-day rainfall depth can be adopted providing flocculation, settlement and discharge can be achieved in that time. However, this will usually require the use of a special range of flocculants and specialised techniques that will achieve sufficiently fast settling (Section E4.2). Many such flocculants can cause environmental harm if not managed properly and the plans for sediment control must also include a detailed plan of management of these.
 - (ii) Where site conditions permit the construction of extremely large structures, a 6 to 20-day rainfall depth can be adopted. These large structures allow longer periods for reuse (e.g. dust suppression) or flocculation, settling and discharge.
- (f) Unless Council's Stormwater Management Plan states differently:^[11]
- (i) on most sites the 75th percentile storm depth is recommended for use if the duration of disturbance is likely to be six months or less, while the 80th percentile storm depth is recommended if the duration of disturbance is likely to be more than six months;
 - (ii) where receiving waters are considered particularly sensitive, either by the development proponent/designer, local council or other consent authority, a higher level of protection can be provided, e.g.: the 80th percentile storm depth is recommended for use if the duration of disturbance is likely to be six months or less, while the 85th percentile storm depth is recommended if the duration of disturbance is likely to be more than six months.
- Longer term land disturbances, such as waste depots, extractive sites and some road construction activities, warrant alternate levels of protection, as defined in relevant sections of Volume 2.
- (g) Where space does not permit the use of structures designed for the 80th percentile or larger x-day rainfall depths and these are desirable, additional erosion controls can be considered instead, e.g. ensuring that the lands:
- (i) are not in a condition of high erosion hazard during those half months when 5 percent or more of the average annual erosion index occurs (Table 6.2); or
 - (ii) have C-factors higher than 0.1 only when the 3-day forecast suggests that rain is unlikely.^[12] In this case, management regimes should be established that facilitate rehabilitation within 24 hours should the forecast prove incorrect.

11. Note that increasing the design criteria from the 75th percentile, 5-day depth to the 90th percentile, 5-day depth more than doubles the size of the settling zone and sometimes triples it.

12. C-factors of 0.1 can be achieved in various ways as shown at Appendix A, note especially figure A5, Table A3 and Table A4. For example, figure A5 shows that a C-factor of 0.1 can be achieved with a 60 percent grass cover where, previously, the soils were stripped or deeply cultivated; alternately, Table A3 shows it can be achieved temporarily by application of a hydraulic soil stabiliser.

(h) Figure 6.5 shows the y -percentile 2, 5, 10 and 20-day rainfall depths (mm) for Sydney's Observatory Hill, while Tables 6.3a and 6.3b shows the 75th, 80th 85th, 90th and 95th percentile 2, 5, 10 and 20-day rainfall depths for 58 sites throughout New South Wales. Similar graphs to figure 6.5 are shown for 57 other sites throughout New South Wales at Appendix L. Rainfall depths at locations not shown, or for time periods not shown (between 2 and 20 days) can be estimated by interpolation or from graphs of rainfall depth estimated from the annual mean rainfall, whichever is the most conservative. Estimation of the 75th, 85th and 95th percentile 5-day rainfall depth from annual mean rainfall is shown in figure 6.6 and also at Appendix L for other locations and situations. Rainfall depths smaller than the 75th percentile depth are shown in figures 6.5 and 6.6 and at Appendix L for illustration purposes only and should not be used in design. Note that rainfall events smaller than 0.2 mm have been omitted in the calculations of all graphs.

(i) Normally, sediment basins where the soils are *Type D* or *Type F* are sized as follows:

$V = \text{settling zone} + \text{sediment storage zone}$ (Table 6.1)

(i) The settling zone capacity designed to capture *Type D* and *Type F* soils can be determined from the y -percentile, 5-day rainfall depth, i.e.

Settling Zone $_{Type D/F} = 10 \times C_v \times A \times R_{(y \%ile, 5 \text{ day})}$

where:

- 10 is a unit conversion factor
- C_v is a volumetric runoff coefficient, defined as that proportion of rainfall that runs off as stormwater^[13]
- A is the catchment area of the basin (hectares)
- $R_{(y \%ile, 5 \text{ day})}$ is the 5-day total rainfall depth (mm) that is not exceeded in y percent of rainfall events. This figure can be determined from Appendix L. Rainfall depths corresponding to management periods more and less than 5 days can be adopted, as site characteristics allow and as detailed previously

The volumetric runoff coefficient should be derived from Appendix F.

(ii) On lands of low erosion hazard (determined through the simple procedure described in Section 4.4.1), the capacity of the sediment storage zones on *Type D* and *Type F* soils can be determined as either:

- 50 percent of the settling zone capacity, or
- two months soil loss as calculated with the RUSLE

¹³. This figure differs from the peak flow runoff coefficient used in the determination of peak flows according to Pilgrim (1998) (Appendix F). The volumetric coefficient of runoff is used for calculations for the sizing of sediment basins on *Type D* and *Type F* soils only.

6. Sediment and Waste Control

Table 6.2 Percentage of average annual EI that normally occurs in the first and second half of each month for each Rainfall Zone (figure 4.9) (Rosewell and Turner, 1992)

Zone	Jan		Feb		Mar		Apr		May		Jun		Jul		Aug		Sep		Oct		Nov		Dec	
1	6	6	7	8	8	8	6	5	5	4	3	2	2	2	2	2	2	2	2	3	3	4	4	4
2	10	9	9	8	7	5	2	2	1	1	2	1	1	1	1	1	3	3	3	4	5	6	7	8
3	6	8	9	9	10	7	7	4	2	2	2	2	2	1	0	1	2	2	2	3	3	4	6	6
4	6	6	8	8	8	5	5	3	3	2	2	2	2	3	3	2	2	3	3	3	5	5	5	6
5	2	3	7	13	13	10	11	6	3	2	3	2	2	2	1	1	1	3	3	3	3	2	2	2
6	11	10	10	9	6	5	2	2	2	1	1	1	1	1	1	1	2	2	4	3	5	5	8	7
7	9	9	7	8	4	5	3	3	2	3	2	1	2	1	2	2	2	3	4	4	4	6	7	7
8	7	8	7	8	5	6	4	3	2	2	2	1	2	1	2	2	2	2	4	4	6	6	7	7
9	8	9	8	7	6	5	3	3	2	2	1	2	1	1	1	2	3	3	5	5	5	6	6	6
10	7	6	9	7	7	6	4	4	3	2	1	1	2	1	1	2	2	3	4	5	6	6	5	6
11	10	11	11	9	10	5	3	1	1	1	1	1	1	1	2	2	1	2	2	5	6	6	6	6
12	10	9	8	7	5	4	4	2	2	1	1	2	1	1	1	2	3	4	3	4	4	6	7	9

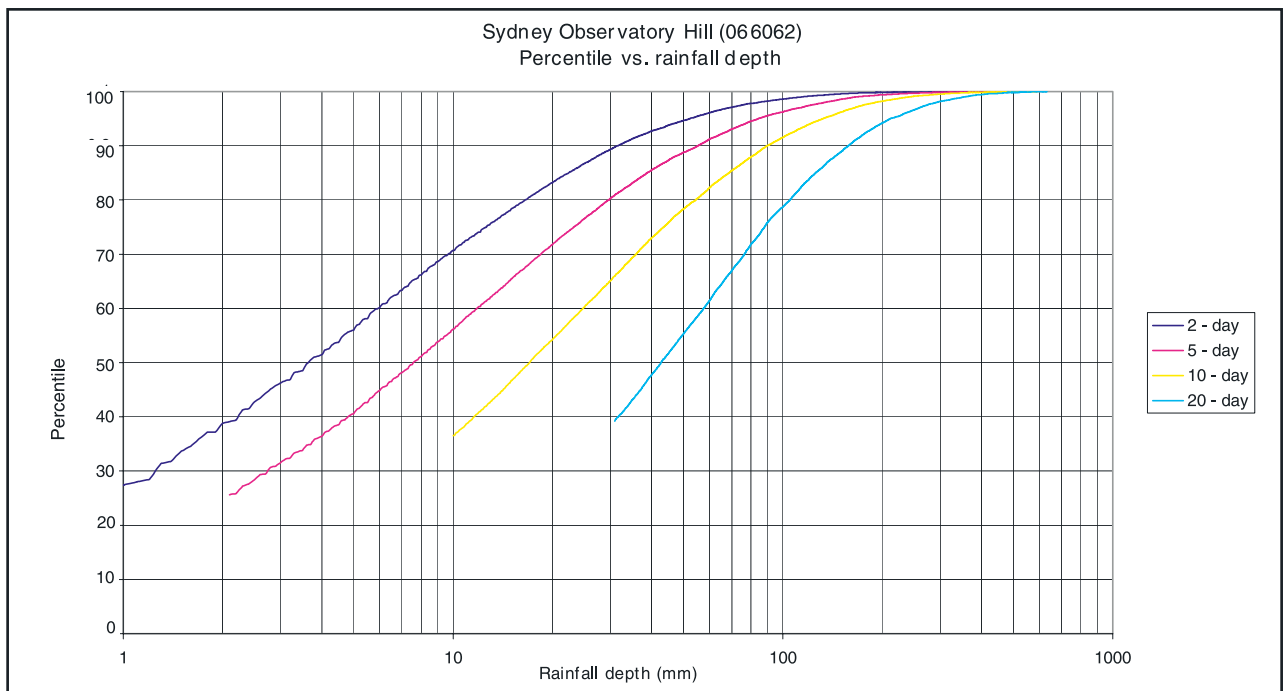


Figure 6.5 Y-percentile 2, 5, 10 and 20-day rainfall depths at Sydney's Observatory Hill

Table 6.3a 75th, 80th, 85th, 90th and 95th-percentile 2 and 5-day rainfall depths for 59 sites in New South Wales

Location	2-day rainfall depths (mm)					5-day rainfall depths (mm)				
	75 th %ile	80 th %ile	85 th %ile	90 th %ile	95 th %ile	75 th %ile	80 th %ile	85 th %ile	90 th %ile	95 th %ile
North Coast										
Coffs Harbour	18.3	23.6	31.8	44.4	70.8	33.6	42.7	55.8	74.9	117.6
Dorrigo	22.1	27.9	36.4	49.0	77.0	40.3	49.3	63.7	84.8	132.0
Grafton	14.0	17.8	22.9	31.2	48.9	23.3	29.0	37.2	50.1	75.4
Lismore	16.3	20.6	26.4	36.3	57.0	28.6	35.3	45.2	60.2	95.3
Port Macquarie	18.0	22.9	29.8	41.4	65.3	32.0	40.1	51.8	70.0	106.2
Taree	15.0	19.0	24.9	35.5	56.4	25.0	31.7	41.2	55.9	90.6
Tweed Heads	23.4	29.5	37.6	50.8	78.7	39.6	48.5	62.5	82.5	126.8
Central Coast/Hunter										
Cessnock	13.4	16.5	21.1	28.5	45.0	20.3	24.4	31.0	42.8	63.0
Gosford (Narara)	16.7	21.3	28.4	39.8	63.0	27.9	35.0	45.8	62.2	99.3
Nelson Bay	17.5	22.3	28.9	39.4	58.9	30.4	38.1	48.3	63.5	91.5
Newcastle	13.7	17.6	23.0	31.8	48.1	24.4	30.5	38.9	51.8	76.7
Scone	12.4	15.3	19.3	25.0	37.8	19.0	22.6	27.7	35.9	51.3
Wyang	16.8	20.8	26.9	37.2	58.8	26.8	33.8	43.2	58.7	90.1
Sydney/Blue Mountains										
Bankstown	11.4	14.5	19.6	27.0	42.0	19.4	24.4	31.5	42.6	66.6
Blacktown	12.0	15.0	20.3	28.0	43.6	19.0	24.6	32.2	43.2	70.8
Camden	13.6	16.8	21.6	29.2	44.8	20.2	25.1	32.0	43.4	66.3
Campbelltown	12.2	15.2	19.0	26.9	42.1	19.3	23.9	30.6	43.2	63.3
Hornsby	15.7	20.6	27.4	38.1	61.0	25.9	32.8	43.3	60.0	92.5
Katoomba	16.5	20.6	26.7	37.6	60.2	28.0	35.2	45.4	63.0	99.6
Lithgow	11.4	14.0	18.3	24.2	35.3	19.5	23.6	29.4	37.8	56.4
Liverpool	12.2	15.5	20.0	28.4	43.2	19.2	24.4	32.2	43.8	70.2
Mona Vale	19.0	23.6	29.2	38.7	62.0	29.0	35.2	44.0	61.2	92.0
Mosman	15.2	19.3	25.4	35.8	57.7	26.2	32.9	43.2	59.6	91.5
Parramatta North	11.7	15.2	20.6	28.2	45.5	20.3	25.8	33.1	45.8	74.1
Penrith	14.0	18.2	23.6	31.5	49.5	21.8	27.4	35.0	47.6	74.6
Richmond	10.2	13.5	18.0	24.9	39.2	17.5	22.4	29.5	39.7	61.4
Ryde	14.7	18.3	24.9	34.3	53.5	23.4	29.5	38.8	53.6	80.5
Springwood	15.5	20.1	25.9	35.0	55.6	25.2	31.4	40.4	55.0	84.1
Sutherland	15.0	18.8	24.9	34.8	55.0	23.4	29.7	38.9	54.6	85.1
Sydney 12.7	16.6	22.4	31.6	52.1	23.3	29.7	38.8	55.2	84.3	
Wallacia	14.0	17.8	23.0	31.4	48.8	22.1	27.6	36.6	48.8	76.2
Wilberforce	11.4	14.9	19.8	27.7	46.4	19.8	24.6	33.2	46.7	69.4
Illawarra/South Coast										
Albion Park	16.5	21.1	27.9	39.1	67.4	25.2	31.8	41.9	59.8	101.2
Batemans Bay	13.7	17.8	24.1	34.2	54.9	22.1	28.0	37.4	52.4	84.4
Bega	12.6	16.1	21.3	30.5	51.1	19.5	24.6	32.5	46.2	77.2
Cooma	7.6	9.8	13.0	17.8	27.2	12.5	15.8	20.0	25.8	39.1
Helensburgh	23.1	28.7	38.1	53.0	81.3	35.6	45.0	57.4	78.2	124.6
Kiama	14.7	19.1	24.9	35.5	57.2	25.5	32.2	42.1	58.3	90.7
Kangaroo Valley	16.8	21.4	29.2	41.7	70.6	26.8	34.2	45.7	67.0	115.6
Mittagong	14.7	18.3	23.4	31.8	49.1	22.9	28.0	36.2	49.0	75.2
Robertson	15.8	20.3	27.9	38.2	67.3	28.4	36.0	46.1	67.3	113.0
Wollongong	13.8	18.0	24.8	36.6	61.3	25.4	33.0	43.5	60.8	95.6
Northern Tablelands and Northwestern Slopes										
Armidale	12.4	15.2	19.3	25.0	35.3	19.8	24.1	29.2	37.4	52.9
Gunnedah	14.2	17.3	21.3	27.7	39.2	20.0	24.1	30.2	38.4	53.0
Tamworth	15.2	18.3	22.2	27.7	39.6	21.6	25.2	30.8	39.2	54.2
Tenterfield	18.8	22.3	26.7	33.8	46.0	26.7	31.4	38.1	47.4	63.3
Central Tablelands and Central Western Slopes										
Bathurst	10.7	13.2	16.5	21.4	30.4	16.8	20.6	24.9	31.4	43.7
Cowra	12.0	14.7	18.0	22.9	32.8	18.1	21.6	26.1	32.5	44.9
Dubbo	12.7	16.0	20.2	26.1	36.0	18.8	22.8	28.4	35.6	50.7
Southern Tablelands and Southwestern Slopes										
Albury	11.8	14.4	17.4	22.4	31.6	20.0	23.7	28.4	35.2	45.2
Goulburn	7.8	10.0	13.2	18.0	27.4	14.2	17.8	22.2	28.6	40.8
Jindabyne	11.9	14.2	17.3	22.6	33.4	17.3	20.6	24.9	32.0	46.8
Queanbeyan	12.7	15.2	18.8	24.2	34.3	18.0	21.3	25.8	33.0	45.1
Wagga	9.2	11.4	14.4	19.3	27.6	15.6	18.8	23.4	29.4	40.2
Northwestern, Southwestern and Far Western Plains										
Bourke	11.7	14.6	18.3	24.8	35.6	15.3	19.0	23.9	30.9	44.5
Broken Hill	7.1	9.1	12.0	16.8	25.9	9.7	12.2	16.2	21.6	33.0
Griffith	9.5	11.7	14.0	18.5	26.2	13.8	16.4	20.6	25.4	34.6
Moree	12.6	15.8	19.3	25.1	36.8	18.0	21.9	26.8	36.3	51.4
Nyngan	12.2	15.2	19.1	25.6	37.3	16.5	20.4	25.8	33.8	47.8

Table 6.3b 75th, 80th, 85th, 90th and 95th-percentile 10 and 20-day rainfall depths for 59 sites in New South Wales

Location	10-day rainfall depths (mm)					20-day rainfall depths (mm)				
	75 th %ile	80 th %ile	85 th %ile	90 th %ile	95 th %ile	75 th %ile	80 th %ile	85 th %ile	90 th %ile	95 th %ile
North Coast										
Coffs Harbour	62.2	75.0	94.0	125.9	181.6	127.0	148.7	174.6	215.0	281.6
Dorrigo	71.2	87.5	108.8	141.4	213.1	142.2	169.1	203.5	257.8	366.2
Grafton	39.4	48.6	60.2	78.3	112.8	76.2	88.9	106.4	130.5	175.2
Lismore	49.8	60.2	75.3	100.4	148.1	98.0	115.6	138.2	176.2	242.0
Port Macquarie	57.9	70.6	88.4	115.0	159.9	116.6	135.4	158.6	193.0	249.0
Taree	43.5	53.5	68.0	91.8	135.8	85.6	101.6	124.6	157.7	207.0
Tweed Heads	67.0	81.0	99.3	130.8	186.8	124.6	147.0	178.6	219.2	288.5
Central Coast/Hunter										
Cessnock	31.0	38.3	48.3	62.3	87.3	57.0	67.0	80.1	99.0	133.4
Gosford (Narara)	49.2	59.7	76.5	100.7	148.6	96.1	113.4	137.0	173.4	239.2
Nelson Bay	53.3	63.8	77.7	99.2	136.7	100.2	117.0	135.2	165.4	219.0
Newcastle	43.9	52.8	64.6	83.3	113.6	85.6	98.6	115.3	139.5	182.4
Scone	28.7	33.9	41.2	52.0	70.6	50.6	57.9	67.7	82.8	109.2
Wyong	45.2	55.4	69.4	89.2	130.9	85.8	100.2	119.9	150.9	208.2
Sydney/Blue Mountains										
Bankstown	33.0	41.4	52.6	69.2	99.5	66.0	80.6	96.0	116.4	161.0
Blacktown	32.6	40.4	51.2	70.2	102.8	64.8	76.2	94.4	117.7	159.4
Camden	31.0	38.2	48.6	63.8	95.0	57.4	67.6	82.7	104.9	143.7
Campbelltown	32.0	39.2	49.9	64.9	100.3	61.6	71.1	87.4	118.7	149.9
Hornsby	44.4	54.9	71.1	91.9	139.4	86.2	100.8	122.8	156.7	214.9
Katoomba	50.1	62.2	78.4	103.8	157.6	101.6	121.4	146.4	183.4	260.0
Lithgow	32.9	38.9	47.5	60.7	84.4	63.9	74.0	86.6	104.4	134.3
Liverpool	33.2	41.0	52.4	70.4	102.0	66.4	79.0	95.8	118.6	156.8
Mona Vale	45.8	56.6	71.2	91.8	129.2	87.1	100.6	120.0	150.1	198.4
Mosman	47.0	57.5	72.8	95.8	137.4	93.2	110.2	131.0	160.9	218.6
Parramatta North	35.4	44.2	56.1	76.4	112.3	70.6	87.0	103.2	131.6	178.5
Penrith	33.8	41.7	52.9	71.4	104.9	61.7	74.1	91.3	118.4	160.4
Richmond	30.7	37.4	47.5	63.4	92.4	59.5	71.1	86.5	108.5	146.9
Ryde	38.4	48.0	61.4	80.6	116.8	72.6	87.0	105.4	130.3	185.3
Springwood	41.4	50.8	63.4	84.8	130.0	77.8	93.4	115.6	148.0	206.1
Sutherland	39.1	48.9	63.0	83.6	124.3	75.9	90.2	109.2	139.7	197.0
Sydney 43.6		54.5	68.6	89.5	132.3	88.0	105.0	125.9	158.1	211.2
Wallacia	35.6	43.6	55.4	75.4	113.1	66.4	81.1	98.7	125.8	173.5
Wilberforce	34.6	43.4	54.6	71.2	107.9	68.6	80.7	96.8	120.6	182.0
Illawarra/South Coast										
Albion Park	41.0	51.7	66.1	93.3	147.8	77.1	95.6	120.6	158.0	226.2
Batemans Bay	37.4	47.3	59.7	81.3	124.8	72.0	87.6	107.5	135.7	187.7
Bega	31.8	39.6	51.6	72.4	111.6	61.4	74.8	93.0	119.1	178.9
Cooma	21.2	25.0	31.0	40.4	59.2	40.6	48.0	57.4	72.2	92.4
Helensburgh	58.2	71.5	89.2	121.7	178.4	105.9	126.1	153.8	200.2	291.1
Kiama	46.0	56.0	71.6	93.1	136.5	90.7	106.7	130.1	161.3	220.7
Kangaroo Valley	45.7	58.8	76.4	107.5	166.4	92.8	112.8	141.3	181.6	254.5
Mittagong	37.1	45.1	56.4	74.6	110.4	69.2	82.1	99.6	122.8	164.6
Robertson	52.2	63.8	101.8	116.2	190.6	108.8	133.3	166.2	217.5	310.7
Wollongong	48.1	58.6	75.2	99.2	150.4	96.2	115.4	138.7	176.4	252.2
Northern Tablelands and Northwestern Slopes										
Armidale	32.7	38.3	45.7	56.8	76.5	60.5	68.0	79.2	93.9	119.5
Gunnedah	29.7	35.1	42.2	52.5	69.6	50.2	57.6	66.7	80.1	102.9
Tamworth	31.6	37.3	44.4	54.4	73.0	53.9	61.8	70.8	84.2	107.2
Tenterfield	39.6	46.1	54.4	66.0	88.6	67.6	76.5	89.4	105.4	128.0
Central Tablelands and Central Western Slopes										
Bathurst	27.2	31.6	37.8	46.3	60.7	49.5	55.7	63.4	74.0	94.3
Cowra	28.0	32.2	38.1	46.8	62.2	48.7	55.4	63.6	74.2	93.8
Dubbo	28.4	33.2	40.0	50.5	66.6	47.5	54.4	64.0	77.0	98.7
Southern Tablelands and Southwestern Slopes										
Albury	32.8	38.6	44.0	52.4	66.1	60.5	66.5	74.4	85.7	102.4
Goulburn	26.4	30.2	36.4	44.8	60.8	49.0	54.8	64.3	75.6	97.1
Jindabyne	26.4	31.2	37.6	47.8	64.3	48.2	55.4	64.7	76.7	96.4
Queanbeyan	26.9	31.5	37.6	45.8	62.3	47.0	53.0	61.6	73.7	93.2
Wagga	26.0	30.2	36.0	43.6	56.8	46.4	52.6	59.8	70.4	86.2
Northwestern, Southwestern and Far Western Plains										
Bourke	20.4	25.2	30.6	39.9	56.8	31.2	37.1	44.8	56.5	79.2
Broken Hill	13.4	16.8	21.4	28.9	41.4	21.8	26.7	32.4	40.6	59.7
Griffith	21.0	24.4	28.4	35.3	46.6	34.4	38.8	45.4	53.6	67.4
Moree	26.4	31.8	39.1	50.6	70.0	46.0	53.4	63.3	78.0	104.1
Nyngan	23.1	27.9	34.8	44.8	61.2	36.6	43.6	52.8	66.3	90.4

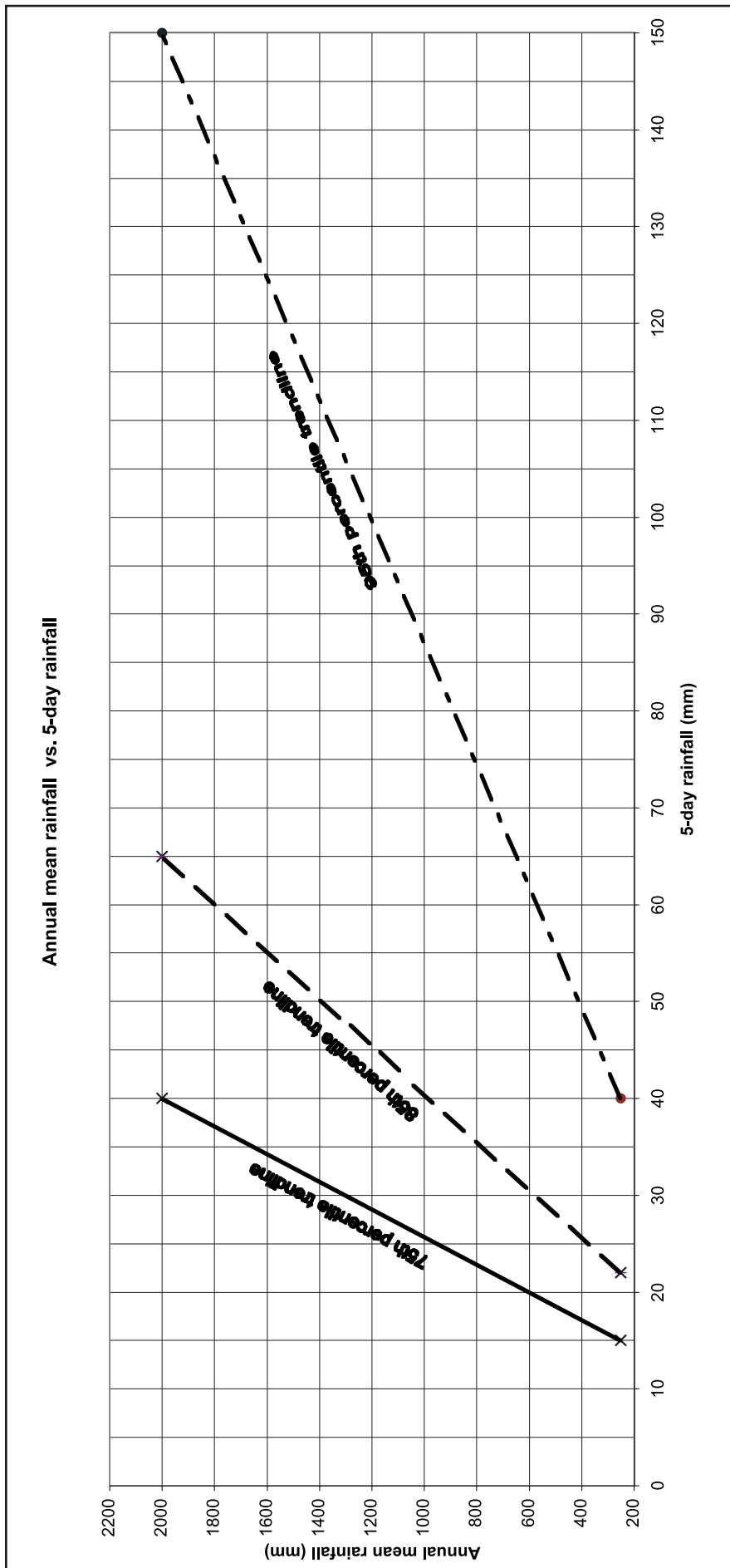


Figure 6.6 The 75th, 85th and 95th percentile 5-day rainfall depth estimated from the annual mean rainfall

6. Sediment and Waste Control

On lands of high erosion hazard (typically Soil Loss Classes 5, 6 and 7), designers should always derive a more specific capacity based on two month soil loss as calculated with RUSLE, the following equation (Appendix A):

$$\text{Sediment Zone }_{Type F / Type D} = \frac{0.17 \times A (R \times K \times LS \times 1.3 \times 1.0)}{1.3}$$

where:

0.17 = one sixth of the computed average annual soil loss

1.3 = the bulk density of the deposited sediment

A = the disturbed catchment area (hectares)

R and K are the RUSLE factors for the site

LS is the RUSLE factor for the site assuming an 80-metre slope length (other slope lengths can be chosen but should be properly justified in erosion control plans).

(iii) In cases where these criteria yield excessively large sediment storage zones, the application of one or more of the following options can help reduce their sizes:

- reducing the catchment areas
- reducing effective slope lengths
- increasing the frequencies of sediment removal.

Standard Worksheets for calculating the size of sediment basins on *Type F* and *Type D* soils are provided in Appendix J.

(j) Management of Sediment Basins on *Type D* and *Type F* Soils:

- (i) With basins that capture runoff from *Type F* soils, stormwater in the settling zone should be drained or pumped out within that time period adopted in the design of the basin (5 days in most cases, but in the range of 2-20 days as site conditions allow) following rainfall if the nominated water quality targets can be met. Flocculation should be employed where extended settling is likely to fail to meet this objective within the nominated time period.
- (ii) Because *Type D* soils contain a significant level of dispersible materials, dosing the captured stormwater with a chemical agent to facilitate settling and help manage the turbidity of discharged stormwater is necessary (Appendix E). For larger land disturbance activities, consideration should be given to establishing a site-specific relationship between suspended solids concentration (also reported as mg/L non-filtrable residue (NFR) and turbidity (measured in nephelometric turbidity units (NTU)) to allow a more rapid assessment of stormwater quality at the site. Samples collected for this purpose should be taken following a reasonable settling period.^[14]

14. Most Australian streams naturally carry sediment loads at some time or another and have reached equilibrium under such conditions. Excessively reducing these loads for extended periods can cause such streams to become "hungry" and erode their own bed and banks.

-
- (iii) Ensure only the clear (<50 mg/L suspended solids) supernatant waters are discharged from the settling zones of these structures. To help in this, use a floating inlet to any pump to reduce the opportunity for picking up any settled sediment
 - (iv) Sediment removed from sediment storage zones where the soils are *Type D* or *Type F* often requires a long time to dry out before it can be handled properly. Consideration should be given to this matter well before maintenance is required. Sediment must be stored, even temporarily, in ways that will not result in sediment pollution to downslope lands and waterways.

6.3.5 Capacity of Basins for *Type C* Soils

- (a) Sediment retention basins on *Type C* soils can be wet or dry basins (SD 6-1, SD 6-2, SD 6-3, SD 6-4 and SD 6-5).
- (b) The basic premise of sediment retention basins on *Type C* soils is that an acceptable discharge water quality can be achieved by providing a relatively short residence time for the settling of a design particle (usually 0.02 mm) (Table 6.1).
- (c) The design storm event for basins on *Type C* soils is taken as the 3-month ARI flow, unless specified differently in the local Council's "Stormwater Management Plan". This design flow should be estimated for individual basin designs, but is commonly about half of the 1-year ARI flow unless the local consent authority specifies differently.^[15]
- (d) In determining peak rates of flow, the minimum critical duration (or time of concentration (tc)) likely to apply throughout the construction period should be adopted. Adopt the recommendations shown at Appendix F for calculation of peak flow runoff coefficients (C10) where the lands are disturbed by removal of vegetation and topsoil (common on building and road construction sites and mining sites). Where the lands are not so disturbed, apply the criteria shown in Pilgrim (1998).
- (e) Three components need to be determined for the settling zone of a sediment basin on *Type C* soils, namely: the surface area, depth, and length:width ratio.^[16]
 - (i) The basin surface area should be equal to or greater than the following:
 - 4,100 square metres per cubic metre of discharge waters per second in the design storm event where the design particle is 0.02 mm^[17]

15. Generally, more than 90 percent of average annual runoff occurs as flows with an ARI of three months or less.

16. Most laboratory studies that have investigated sediment basin design have occurred in environments where such factors as short-circuiting, turbulence, bottom scour, outlet design and temperature had minimal if any effect on their efficiencies. The reality is such an ideal basin is never constructed, despite very good intentions. Further, the particles being tested are usually perfectly spherical, have uniform densities and cannot interact with one another, factors that do not occur with real soils.

17. A basin surface area of 4,100 square metres is based on the equation $A = 1.2 Q / V_s$ where A is the required basin surface area (m²), Q is the peak flow rate in the design storm (m³/sec) and V_s is the settling velocity of the design particle (0.00029 m/s for a particle of 0.02 mm diameter (Goldman *et al* (1986)).

6. Sediment and Waste Control

- 635 square metres per cubic metre of discharge waters per second where it is 0.05 mm
- 170 square metres per cubic metre of discharge waters per second where it is 0.1 mm.

In most cases, the design particle should be taken as 0.02 mm. However, the larger sizes can be considered where at least 90 percent of those particles coarser than 0.02 mm are, in fact, coarser than 0.05 or 0.1 mm.

- (ii) The depth of the settling zone should be at least 0.6 metres, sufficient to provide a cross-sectional flow area that limits flow velocities to values unlikely to scour settled sediment in a 1-year ARI flow, namely 0.07 metres per second for a particle of 0.02 mm diameter. If a less frequent storm event has been adopted (greater than the 1-year ARI) or if site constraints limit the depth of the sediment retention basin, a check should be made to ensure that the average flow velocity in the design storm event does not exceed the scour velocity for a particle of 0.02 mm diameter.^[18]
- (iii) Length:width ratios should be 3 to 1 or greater as discussed above at Section 6.3.3(i).
- (iv) On lands of low erosion hazard, as determined by the simple procedure described in Section 4.4.1, the capacity of the sediment storage zones on Type C soils can be determined simply as 100 percent of the settling zone capacity. On lands of high erosion risk (typically Soil Loss Classes 5, 6 and 7), or as an alternative in any case, designers can derive a more specific capacity using the following equation (Appendix A):

$$\text{Sediment Zone } T_{\text{Type F}} / T_{\text{Type D}} = \frac{0.17 \times A (R \times K \times LS \times 1.3 \times 1.0)}{1.3}$$

where:

0.17 = one sixth of the computed average annual soil loss

1.3 = the bulk density of the deposited sediment

A = the disturbed catchment area (hectares)

R and K are the RUSLE factors for the site

LS is the RUSLE factor for the site assuming an 80-metre slope length (other slope lengths can be chosen but should be properly justified in erosion control plans).

- (v) On Soil Loss Classes 5, 6 and 7 lands, designers should derive the specific capacity using the above equation only.
- (vi) In cases where these criteria yield excessively large sediment storage zones, the application of one or more of the following options can help reduce their sizes:
- reducing the catchment areas

18. Metcalf and Eddy (1991) suggest a scour velocity of 0.07 m/s for a particle of 0.02 mm diameter.

- reducing effective slope lengths
- increasing the frequencies of sediment removal.

Standard Worksheets for calculating the size of sediment basins on *Type F* and *Type D* soils are provided in Appendix J.

- (f) Techniques for dewatering *Type C* sediment basins commonly involve the use of needle-punched geotextile, sand or gravel as mediums near the outlet. The use of sand or gravel as a filtering medium is not encouraged because it is more difficult to maintain. Geotextile should be placed:
- on the upstream side of gabions (figure 6.7);
 - on 50 to 75 mm aggregate (maximum batter gradient 1.5(H):1(V)) placed on the upstream side of a wall constructed from local rock materials (figure 6.8); or
 - around a perforated riser structure. An air gap is essential between the riser structure and the geotextile to ensure free drainage of “dry” basins. The geotextile should not be in close contact with the riser (SD 6-3).
- (g) Whichever method is used, reverse flush or replace the geotextile each time sediment is removed from the basin to reduce the likelihood of the pores blocking and becoming essentially a wet basin. Consequently, do not sandwich the fabric between gabion baskets.
- (h) Operation of basins on *Type C* soils should ensure that, where possible, water has drained from the settling zone by the beginning of the next storm event. This can be achieved with dry, above-ground basins, through use of geotextile filters or similar mechanisms.^[10]

6.3.6 Infiltration sumps

- (a) Infiltration sumps (Standard Drawing SD 6-6) are subsurface facilities that collect stormwater for filtration of sediment and infiltration of stormwater to the watertable. They are used as an alternative to the regular sediment retention structures described above where:
- construction of regular structures can be impractical, (e.g. where most of the site will be disturbed for building purposes)
 - the soils are well drained (Soil Hydrologic Groups A or B)
 - the watertable (seasonal or permanent) is more than 2 metres below the floor of the structure (Chapter 3)
 - addition of water to the watertable will not affect salinity levels – testing soils for the presence of soluble salts is essential (Chapter 3)
 - groundwater cannot be contaminated
 - catchment areas are very small.

Infiltration technology is not supported by the DIPNR unless the soils and groundwater have been properly assessed for their capability.

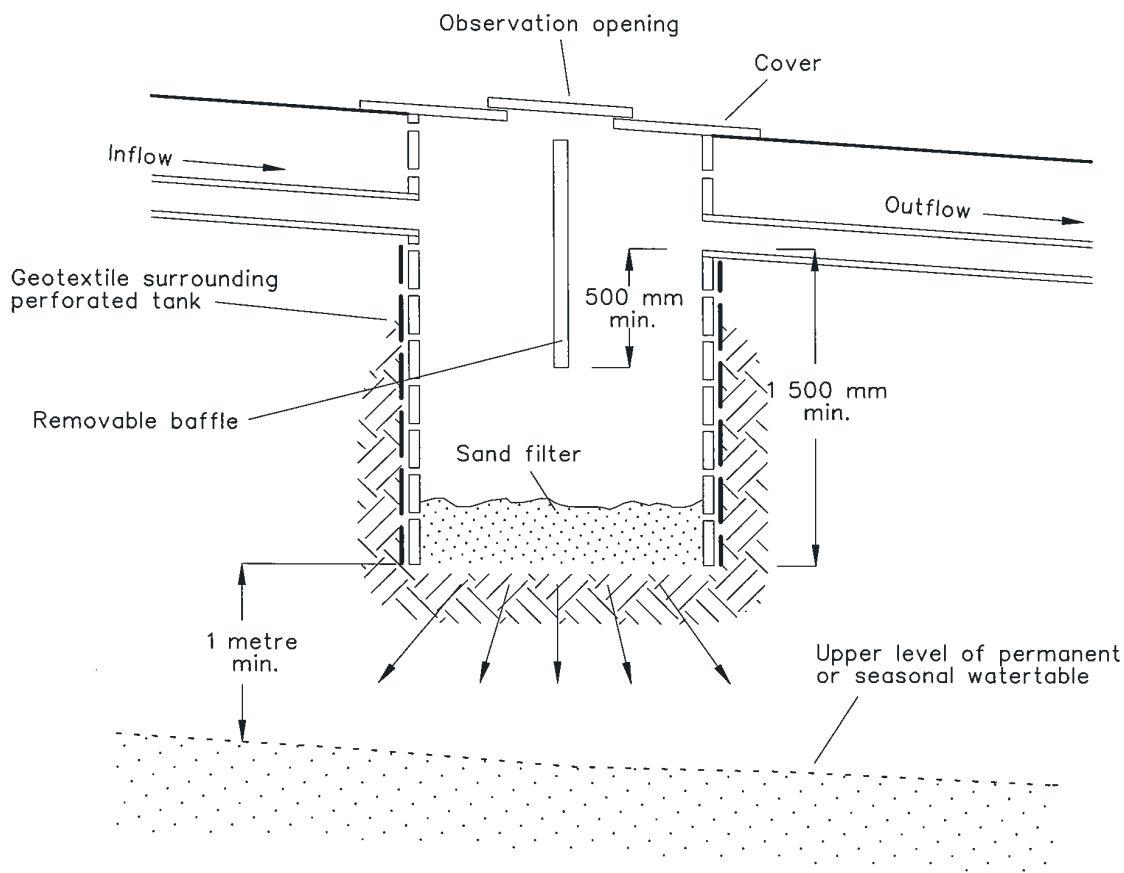
6. Sediment and Waste Control



Figure 6.7 A sediment retention basin constructed on Type C soils with gabion baskets in very steep country. The structure has recently been converted to a constructed wetland.



Figure 6.8 A sediment retention basin constructed on Type C soils from local sandstone gibbers



Construction Notes

1. Join the inlet to the polluted supply taking any suitable step to remove bulky material before it can enter the sump.
2. Connect the outlet to a safe disposal area following the ESCP/SWMP.
3. Place a geotextile liner on the outside of the pit.
4. Install a removable baffle, central to the inflow/outflow and normal to the direction of flow, ensuring that it reaches 500 mm below the invert of the outlet pipe.
5. Install a cover over the pit with an observation port and access cover.

INFILTRATION SUMP

SD 6-6

6. Sediment and Waste Control

- (b) Generally, infiltration sumps are constructed from floorless plastic or metal tanks with perforated sides and surrounded with geotextile to filter the water before it enters the soil. The perforations should comprise at least 2.5 percent of the total surface area (preferably 7.5 percent), and be evenly placed to ensure water is delivered over the entire facility. Provide an aggregate bed at least 600 mm wide between the tank and the surrounding soil materials (aggregate coarser than the perforations).
- (c) The capacity of the sump should accord with that for basins on *Type C* soils, but should have a settling zone depth greater than 1.5 metres.
- (d) Provide an accessible observation point to allow estimates to be made about how quickly the tank will dewater following a storm event and to measure sediment levels. Inspect them after every storm event large enough to produce runoff. Pump them out 36 to 48 hours after each storm event if:
 - fines block the geotextile and/or floor of the structure
 - the infiltration rate drops below 15 mm per hour.Of course, flocculation might be necessary first.
- (e) Maintain design capacity always through regular removal of sediment.

6.3.7 Sediment Filters

- (a) Sediment filters (also called sediment retention traps) are temporary measures used in mitigation of sediment pollution to downslope lands and waterways. They are relatively effective at retaining suspended solids coarser than 0.02 mm. Many finer particles and most soluble materials pass through them. They are simple to construct, relatively inexpensive and easily moved as development proceeds.
- (b) Materials used in their construction include one or more of straw bales, woven geotextile, earth, rock or suitable crushed concrete products. Generally, actual choice is dependent on constraints imposed by the design criteria (including maintenance needs), availability of materials, cost and site conditions. Straw bales should not be used where they cannot be properly embedded into the ground unless alternative measures are taken to prevent polluted water passing under them.
- (c) Place them to keep sediment as close to its source as possible.
- (d) Maintain sediment filters so that no more than 30 percent of their design capacity is lost to accumulated sediment and construction materials are replaced when functionality is lost. Dispose of any waste material in an approved manner and where further pollution to downslope lands and waterways should not occur.
- (e) Some filters are constrained by external design criteria, including sediment fences and straw bale barriers (Standard Drawings SD 6-7 and SD 6-8 and figure 6.9). They should be able to withstand the erosive forces from the design storm event, usually the 10-year ARI time of concentration event and, therefore, should not be

placed in areas of concentrated water flows. Catchment areas of sediment fences can be constrained by building them along the contour with periodic small returns (figure 6.10) creating several subcatchments. Because these systems are prone to failure in relatively small storm events, subcatchment areas should be sufficiently small to constrain maximum flows to 50 litres per second in the design storm event should all water discharge at one point.



Figure 6.9 Sediment fence constructed below a fill batter – the sediment pollution is the result of a recent storm event

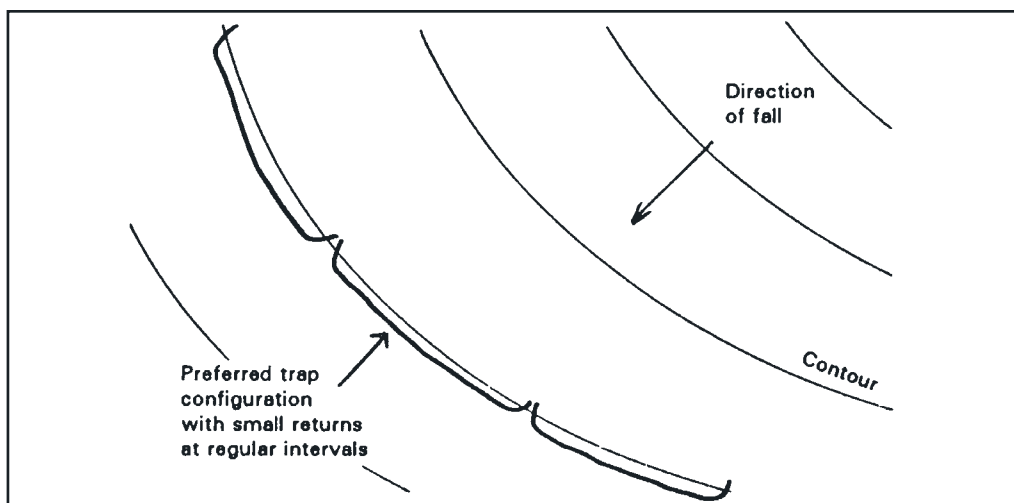
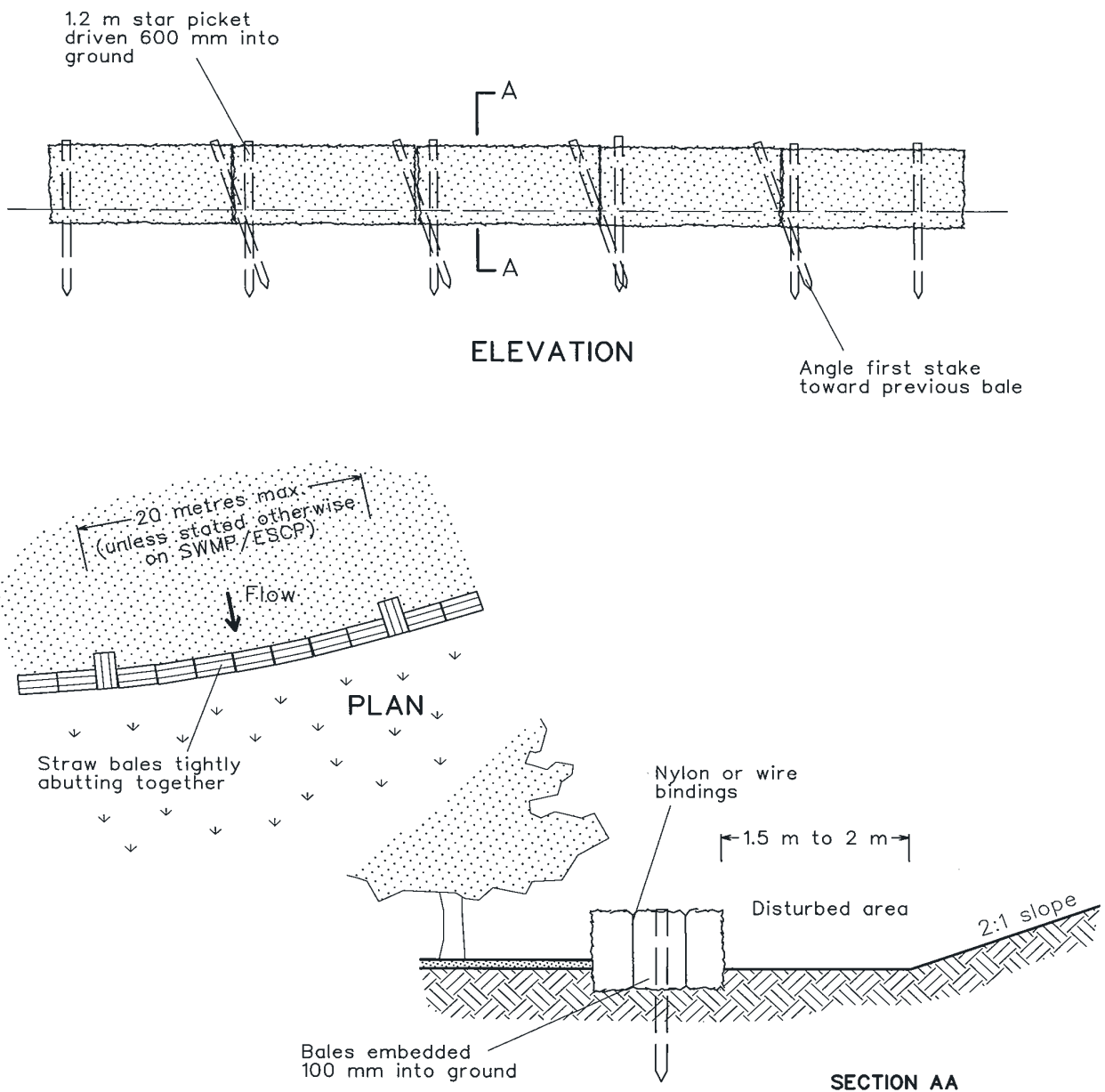


Figure 6.10 Preferred sediment fence configuration

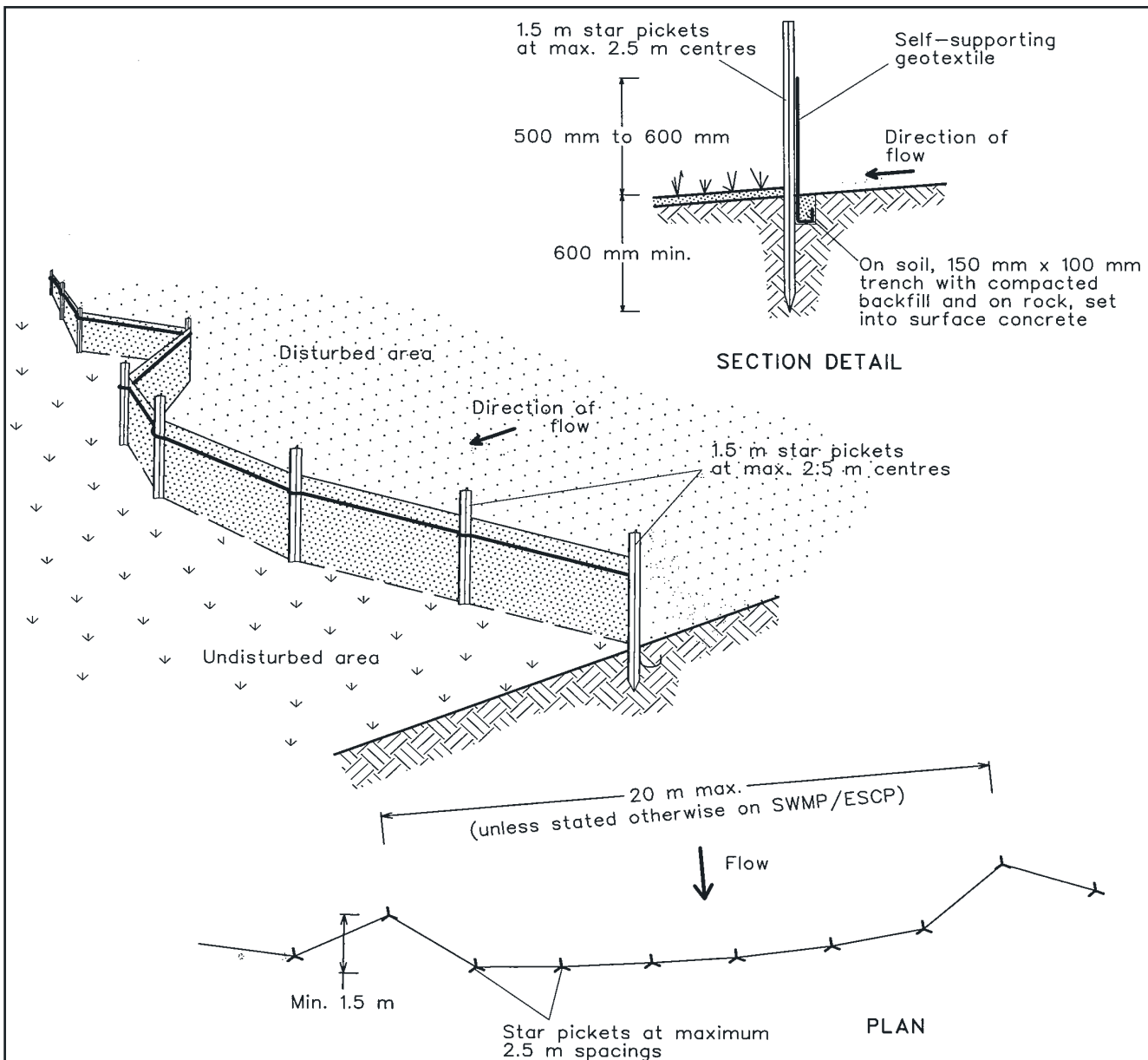


Construction Notes

1. Construct the straw bale filter as close as possible to being parallel to the contours of the site.
2. Place bales lengthwise in a row with ends tightly abutting. Use straw to fill any gaps between bales. Straws are to be placed parallel to ground.
3. Ensure that the maximum height of the filter is one bale.
4. Embed each bale in the ground 75 mm to 100 mm and anchor with two 1.2 metre star pickets or stakes. Angle the first star picket or stake in each bale towards the previously laid bale. Drive them 600 mm into the ground and, if possible, flush with the top of the bales. Where star pickets are used and they protrude above the bales, ensure they are fitted with safety caps.
5. Where a straw bale filter is constructed downslope from a disturbed batter, ensure the bales are placed 1 to 2 metres downslope from the toe.
6. Establish a maintenance program that ensures the integrity of the bales is retained - they could require replacement each two to four months.

STRAW BALE FILTER

SD 6-7



Construction Notes

1. Construct sediment fences as close as possible to being parallel to the contours of the site, but with small returns as shown in the drawing to limit the catchment area of any one section. The catchment area should be small enough to limit water flow if concentrated at one point to 50 litres per second in the design storm event, usually the 10-year event.
2. Cut a 150-mm deep trench along the upslope line of the fence for the bottom of the fabric to be entrenched.
3. Drive 1.5 metre long star pickets into ground at 2.5 metre intervals (max) at the downslope edge of the trench. Ensure any star pickets are fitted with safety caps.
4. Fix self-supporting geotextile to the upslope side of the posts ensuring it goes to the base of the trench. Fix the geotextile with wire ties or as recommended by the manufacturer. Only use geotextile specifically produced for sediment fencing. The use of shade cloth for this purpose is not satisfactory.
5. Join sections of fabric at a support post with a 150-mm overlap.
6. Backfill the trench over the base of the fabric and compact it thoroughly over the geotextile.

SEDIMENT FENCE

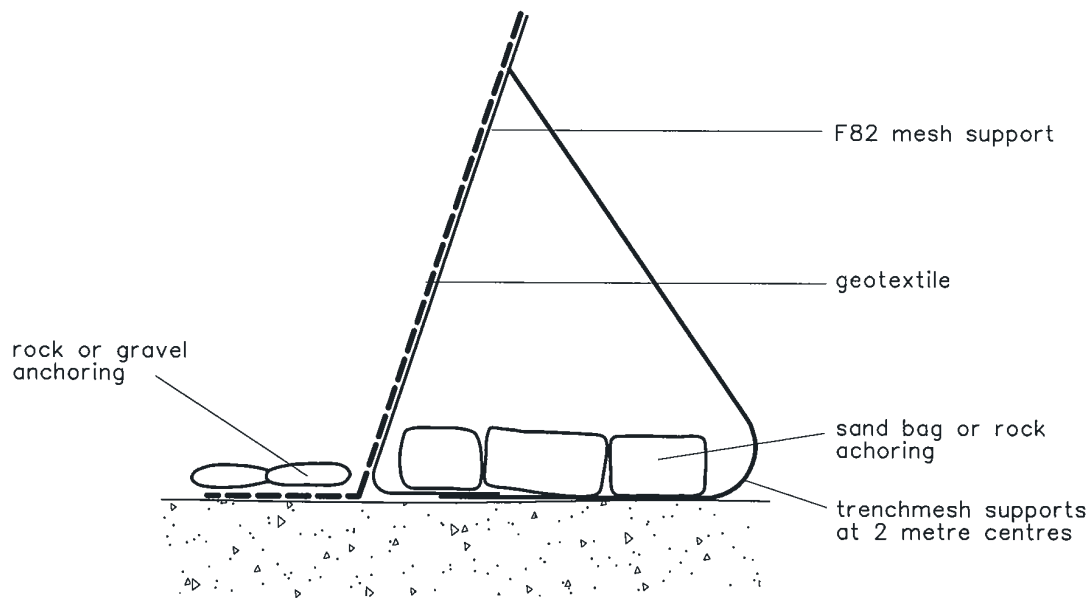
SD 6-8

6. Sediment and Waste Control

- (f) Special measures must be installed for trapping sediment in intertidal zones, e.g. sediment fences as shown in Standard Drawing SD 6-9.
- (g) Floating sediment fences can be constructed below the intertidal zone, providing sufficient water depth is always available for the boom to float (Standard Drawing SD 6-10). They can be used to surround barges when transferring materials to and from the shore or when carrying out dredging activities. Maintenance of fixed or floating sediment fences should be undertaken only at low tides.
- (h) Other filters are not constrained by external design criteria, including inlet filters (figure 6.11 and Standard Drawing SD 6-11 and SD 6-12). They are among the least effective of all BMPs at mitigating sediment pollution because their design does not take into account runoff volume. Their installation at any particular location is a matter for the site manager on a day-to-day basis as an informal part of the sediment control program and not normally detailed on any P1an. Nevertheless, they should be placed so that they are unlikely to divert water from its intended course in a very large storm event.

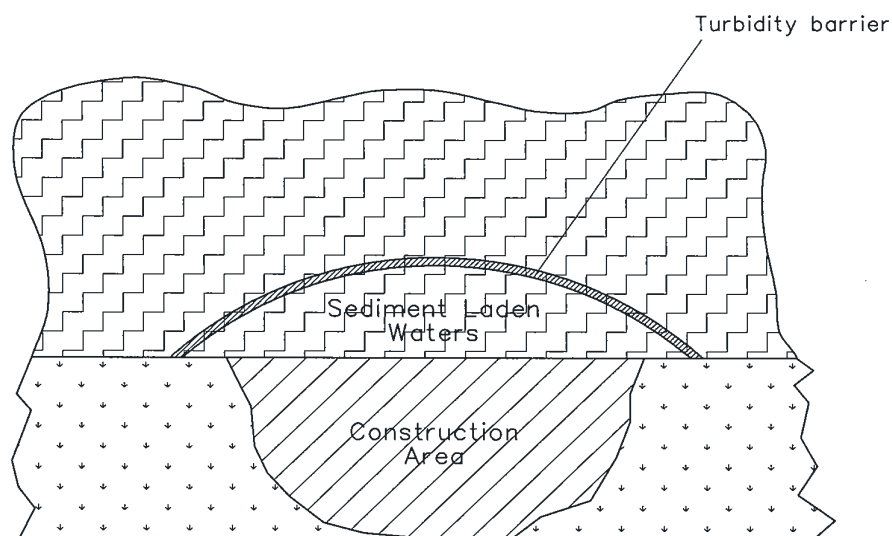
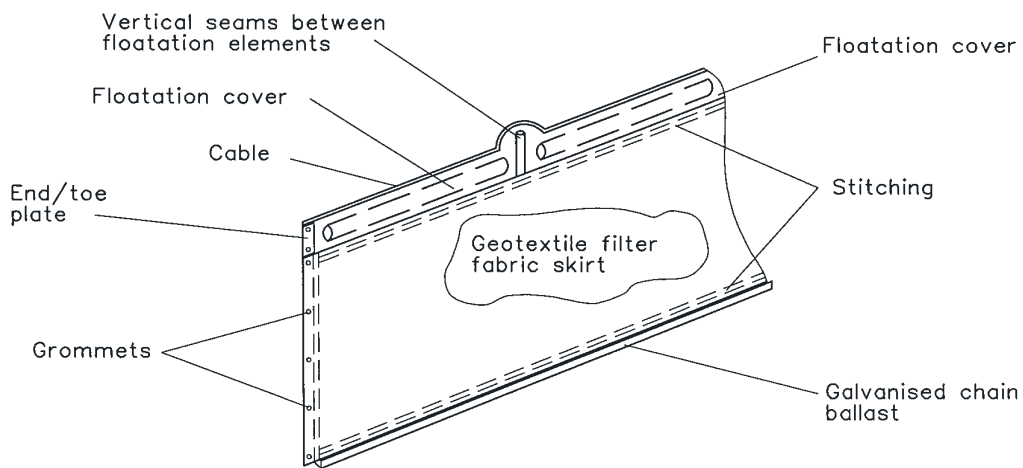


Figure 6.11 Filter roll at kerb-side sump



Construction Notes

1. Install this type of sediment fence when use of support posts is not desirable or not possible. Such conditions might apply, for example, where approval is granted from the appropriate authorities to place these fences in highly sensitive estuarine areas.
2. Use bent trench mesh to support the F82 welded mesh facing as shown on the drawing above. Attach the geotextile to the welded mesh facing using UV resistant cable ties.
3. Stabilise the whole structure with sandbag or rock anchoring over the trench mesh and the leading edge of the geotextile. The anchoring should be sufficiently large to ensure stability of the structure in the design storm event, usually the 10 year event.

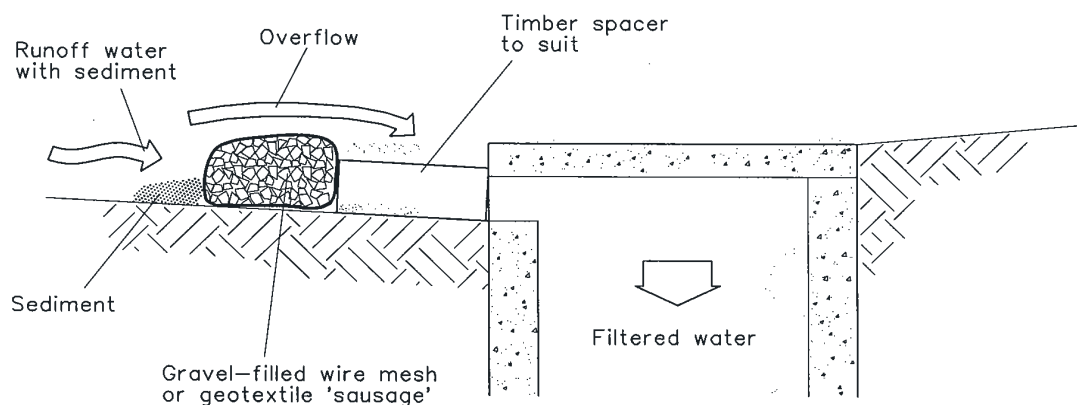
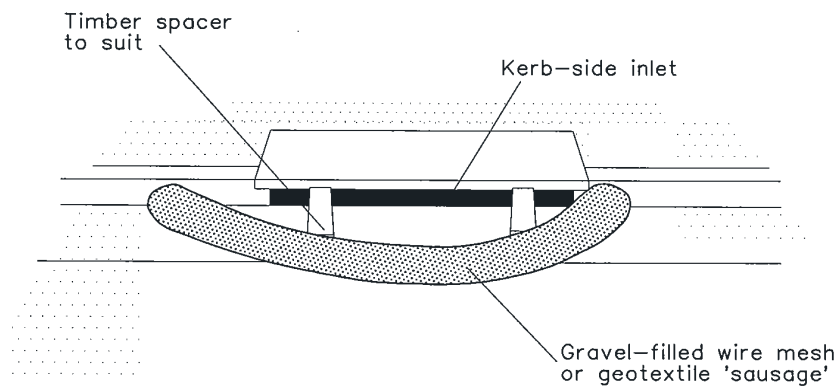


Construction Notes

1. Use turbidity barriers only where high flows are unlikely to remove accumulated sediment and/or move the curtain significantly.
2. Where the barrier is to remain in place for more than one month, ensure the floatation cover is a UV-resistant, durable material.
3. Use only closed cell foam or foam-filled PVC piping as floatation elements. Do not use unfilled pipes.
4. Use only woven or heat-set non woven geotextiles. Needle-punched, non woven geotextiles can become fouled with debris that fray and delaminate them as they move with the waves or currents.
5. Remove captured sediment before the barrier is decommissioned.
6. In tidal areas, ensure the barrier can rise and fall without being moved from its position.

TURBIDITY BARRIER

SD 6-10



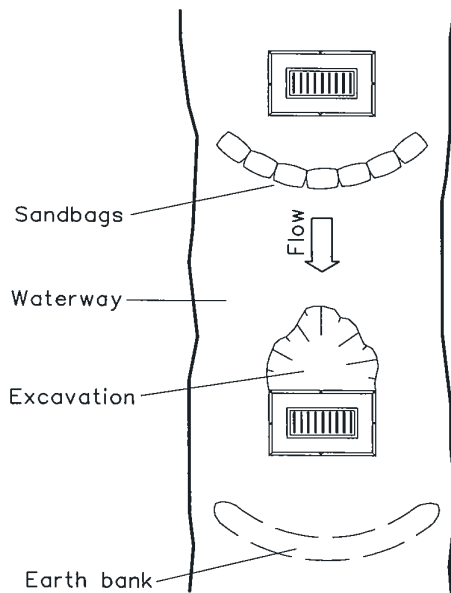
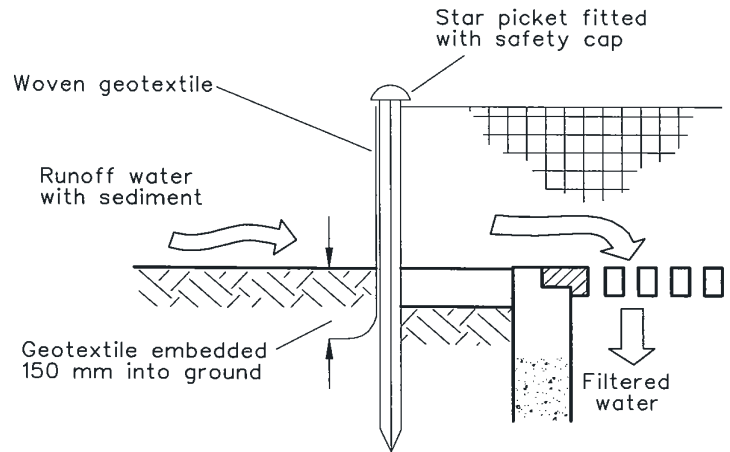
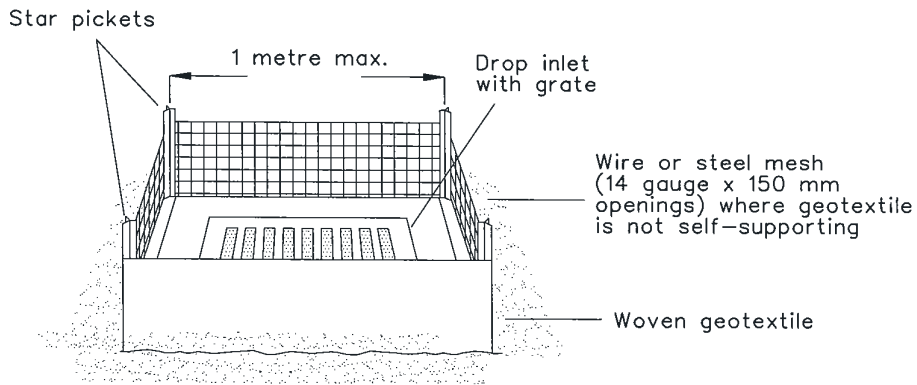
NOTE: This practice only to be used where specified in an approved SWMP/ESCP.

Construction Notes

1. Install filters to kerb inlets only at sag points.
2. Fabricate a sleeve made from geotextile or wire mesh longer than the length of the inlet pit and fill it with 25 mm to 50 mm gravel.
3. Form an elliptical cross-section about 150 mm high x 400 mm wide.
4. Place the filter at the opening leaving at least a 100-mm space between it and the kerb inlet. Maintain the opening with spacer blocks.
5. Form a seal with the kerb to prevent sediment bypassing the filter.
6. Sandbags filled with gravel can substitute for the mesh or geotextile providing they are placed so that they firmly abut each other and sediment-laden waters cannot pass between.

MESH AND GRAVEL INLET FILTER

SD 6-11



For drop inlets at non-sag points, sandbags, earth bank or excavation used to create artificial sag point

Construction Notes

1. Fabricate a sediment barrier made from geotextile or straw bales.
2. Follow Standard Drawing 6-7 and Standard Drawing 6-8 for installation procedures for the straw bales or geofabric. Reduce the picket spacing to 1 metre centres.
3. In waterways, artificial sag points can be created with sandbags or earth banks as shown in the drawing.
4. Do not cover the inlet with geotextile unless the design is adequate to allow for all waters to bypass it.

-
- (i) Developed areas, especially inner city areas with space constraints, need careful management of activities to prevent sediment pollution. This is particularly evident where building materials such as sand, fill material and topsoil, etc. are deposited near areas of concentrated water flows, e.g. on footpaths or side of the roads. In such instances, it is essential that stormwater flows in gutters and other surface drains are not impeded nor can they result in materials being washed into drainage systems. Downstream pit protection should be implemented and ongoing maintenance should be provided; pedestrian and vehicular safety and warning devices should be erected.

6.3.8 Filter Strips

- (a) Strips of vegetation left or constructed downslope from earthworks provide a simple method of trapping coarse sediment in most storm events other than very large ones. This assumes that, where this vegetation is to be retained, it will have sufficient time to “recover” before the next load of sediment-laden water enters the site.
- (b) The following factors should be considered in their design:
- (i) the amount of sediment that might be stored in the area above the filter; and
 - (ii) the width of vegetation in the filter:
 - required to filter coarse sediment (usually the upper section)
 - required filter some of the finer sediment (usually the lower section).
- (c) Native vegetation in riparian zones should not be used as filter strips. Only separate dedicated buffer zones upslope from riparian lands should be used.
- (d) Karssies and Prosser (2001) suggest that the following amounts of sediment can be stored above the filter:
- where slopes are less than 4 percent, up to 50 tonnes per hectare per 100 metres length
 - where slopes are between 4 and 7 percent, up to 15 tonnes per 100 metres length
 - where slopes are between 8 and 10 percent, up to 10 tonnes per 100 metres length.

That significant amounts of sediment are stored in the area above the filter is shown in Figure 6.12.

- (e) The suggested widths of grass filters for calculated values of annual soil losses (Appendix A) are in Table 6.4. Note that, generally, vegetated filter strips are most effective where the average annual soil losses are low and the sediment is relatively coarse; they are least effective where the calculated average annual soil losses are

6. Sediment and Waste Control

Table 6.4 Recommended Grass Filter Strip Widths for Typical Values of Calculated Annual Soil Loss (Karssies and Prosser, 2001)

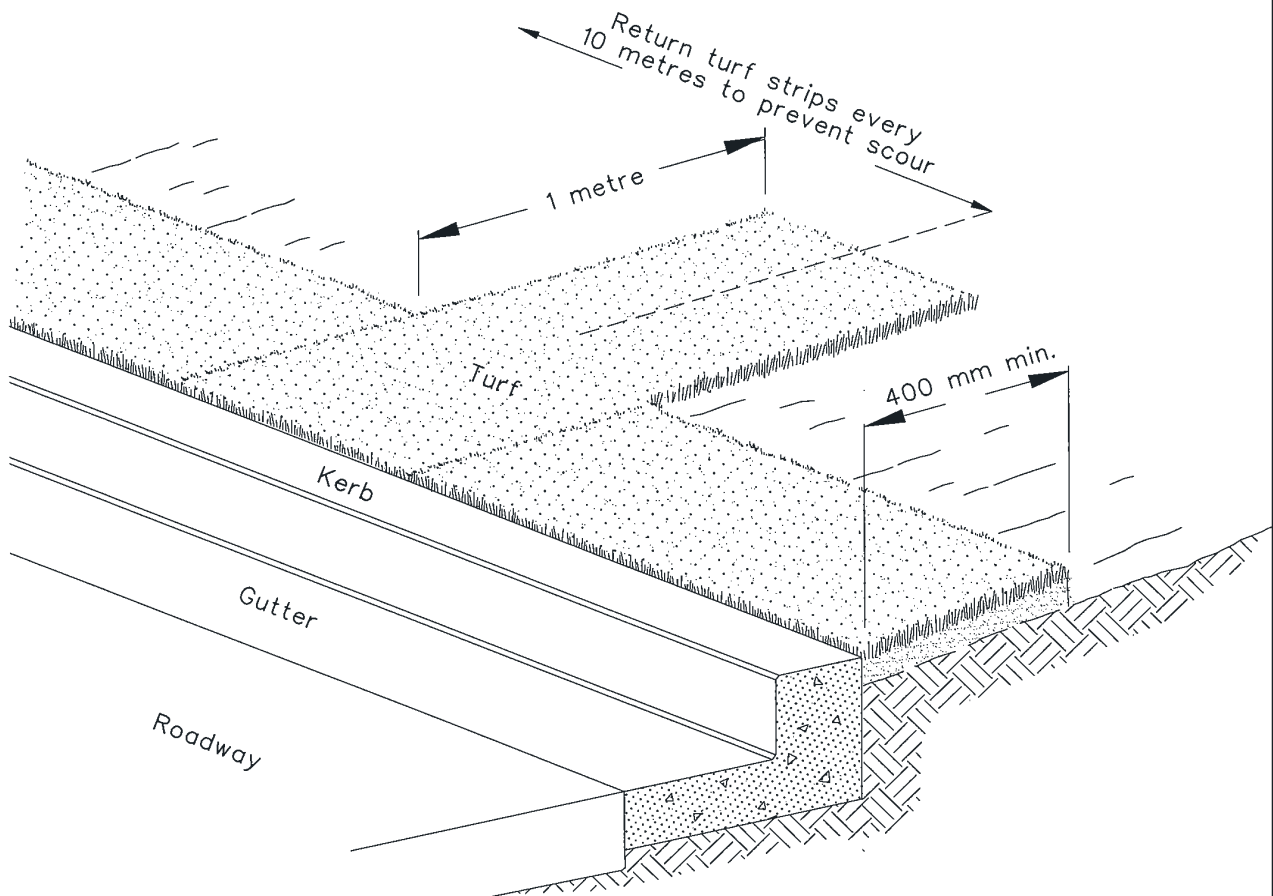
Soil loss (t/ha/yr)	Filter strip gradient (%)									
	1	2	3	4	5	6	7	8	9	10
1	2m	2 m	2 m	2m	2 m	2 m	2 m	2 m	2 m	2 m
2	2m	2 m	2 m	2m	2 m	2 m	2 m	2 m	2 m	2 m
5	2m	2 m	2 m	2m	3 m	3 m	3 m	4 m	4 m	4 m
10	2 m	2 m	2 m	5m	6 m	6 m	7 m	7 m	7 m	7 m
20	3 m	9 m	11 m	12 m	12 m	13 m	13 m	13 m	13 m	14 m
30	9 m	15 m	17 m	18 m	19 m	19 m	19 m	20 m	20 m	20 m
40	15 m	21 m	23 m	24 m	25 m	25 m	26 m	26 m	26 m	26 m
50	22m	28 m	NR	NR	NR	NR	NR	NR	NR	NR
60	28m	NR	NR	NR	NR	NR	NR	NR	NR	NR
70	NR	NR	NR	NR	NR	NR	NR	NR	NR	NR

more than about 40 tonnes per hectare per year and/or the sediment is relatively fine.

- (f) The best vegetation cover is one that provides a relatively uniform dense ground cover, e.g. sward-forming grasses about 150 mm high.
- (g) A 400-mm wide grass strip can be installed next to a kerb to stabilise the interface between the kerb and footway (Standard Drawing SD 6-13). Also, it can provide worthwhile sediment trapping value in very small storm events.

6.3.9 Stabilised Site Access

- (a) Access to sites should be stabilised (Standard Drawing 6-14) to reduce the likelihood of vehicles tracking soil materials onto public roads and ensure all-weather entry/exit. Such areas should be at least 3 metres wide (or 2.4 metres per lane) and constructed with maximum 75 mm aggregate at least 15 metres long and 200 mm thick, underlain by needle-punched geotextile.
- (b) It is very important that:
 - surface water flows are diverted from the area
 - the structures are placed so that bypassing them is not possible for vehicles
 - they are maintained in an effective condition through removal of sediment and/or addition of extra aggregate.
- (c) A variation on the design shown in SD 6-14 where tracking of sediment onto local public roads is likely to be a problem is the use of cattle grids installed under water (figure 6.13).



Construction Notes

1. Install a 400-mm minimum wide roll of turf on the footpath next to the kerb and at the same level as the top of the kerb.
2. Lay 1.4 metre long turf strips normal to the kerb every 10 metres.
3. Rehabilitate disturbed soil behind the

KERBSIDE TURF STRIP

SD 6-13

6. Sediment and Waste Control



Figure 6.12 A kerbside turf strip showing sediment stored in the area above the filter.



Figure 6.13 A simple wash-down system.

(d) In addition, the following limitations should be considered:

- (i) Wash-down areas and stabilised accesses require collection and treatment of waste water;
- (ii) Ideally, both should be built on level areas; and
- (iii) Supplementary, street sweeping on adjacent roads might still be required.

6.3.10 Control of Wind Erosion

(a) Research (Livingston, *et al.*, 1988) has shown that average dust emission rates of over 2.5 tonnes per hectare per month occur at urban construction sites.

(b) Various measures are available to minimise such emissions, including:

- (i) limiting the area of lands exposed to erosive forces through:
 - phasing works (Chapter 4)
 - provision of a protective ground cover including mulches, vegetation (Chapter 7), organic binders or dust retardants
 - keeping the ground surface damp (not wet)
 - leaving the surface in a rough cloddy condition to increase roughness and slow surface wind speed;
- (ii) limiting traffic movement on any disturbed areas;
- (iii) applying a suitable hydraulic soil stabiliser to the soil surface to reduce the C-factor (Appendix A); and

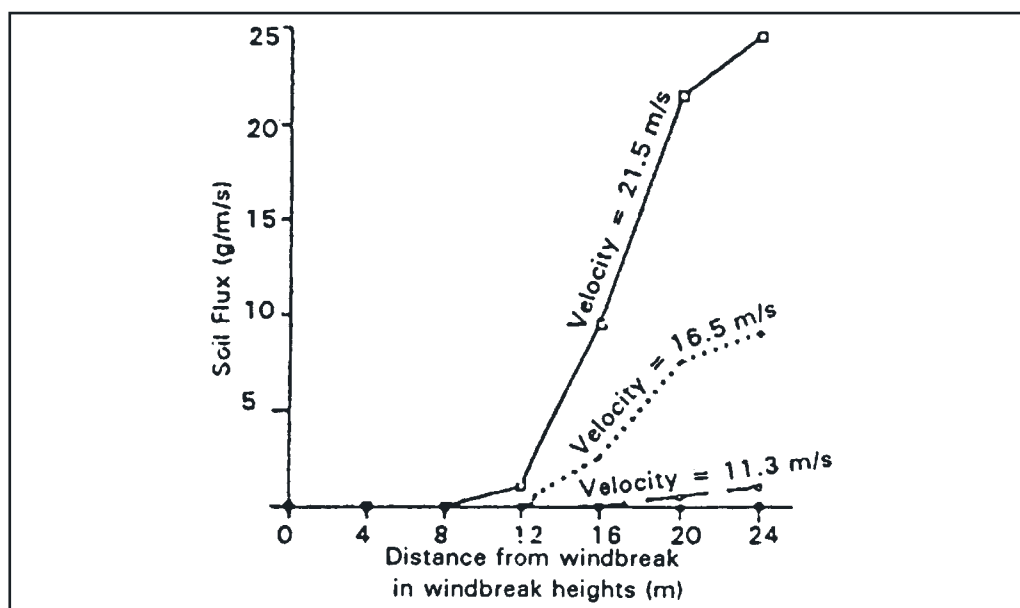


Figure 6.14 Effect of distance from windbreak on soil loss, wind blowing at less than 90° to the windbreak (Leys, 1991)

6. Sediment and Waste Control

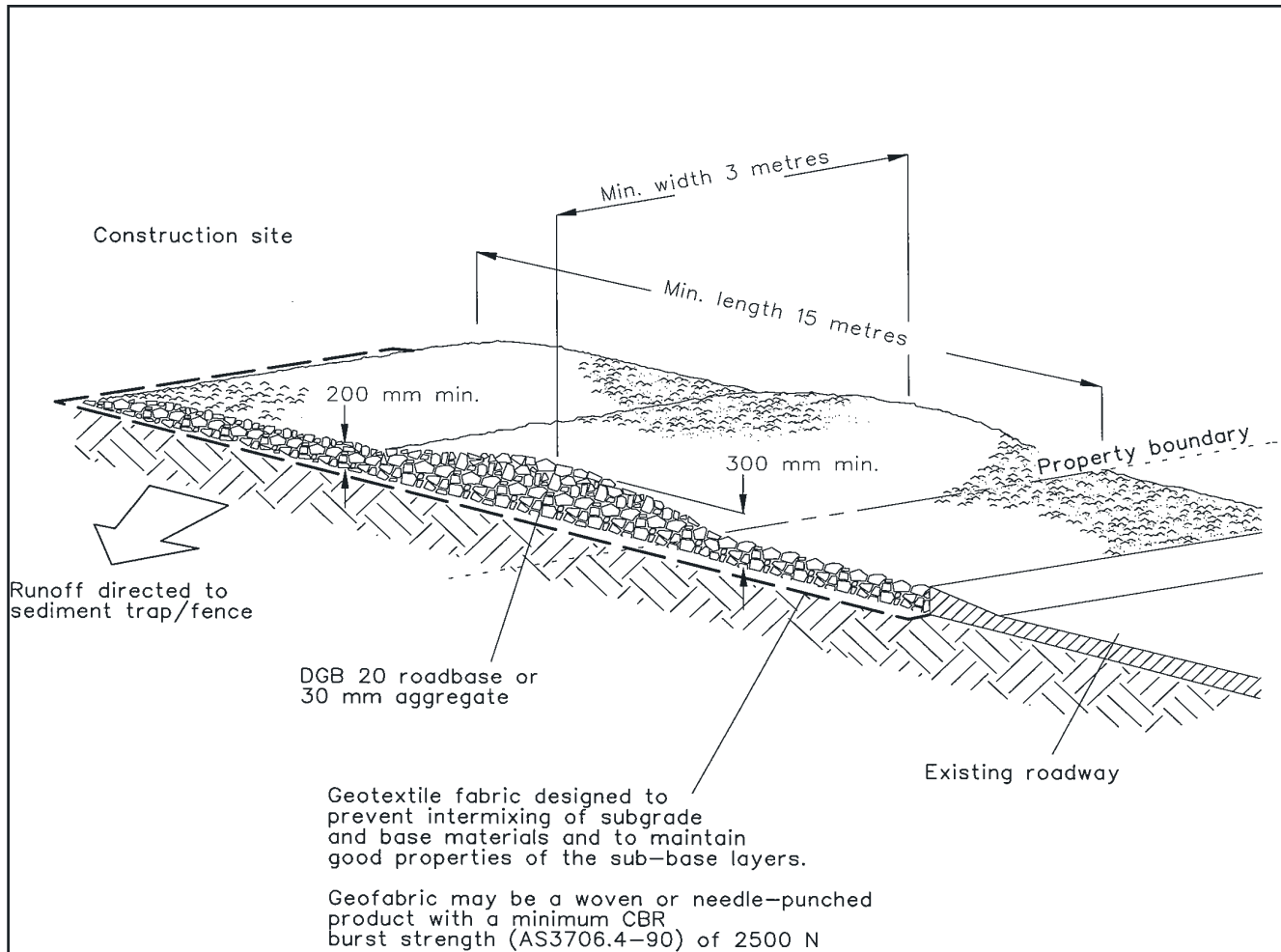
- (iv) on building sites where 1,500 to 5,000 square metres are to be disturbed, installing a 40 percent porous, open-weave barrier fence (Standard Drawing SD 6-15) on the windward side.^[19]

6.4 Constructed Wetlands

6.4.1 Preamble

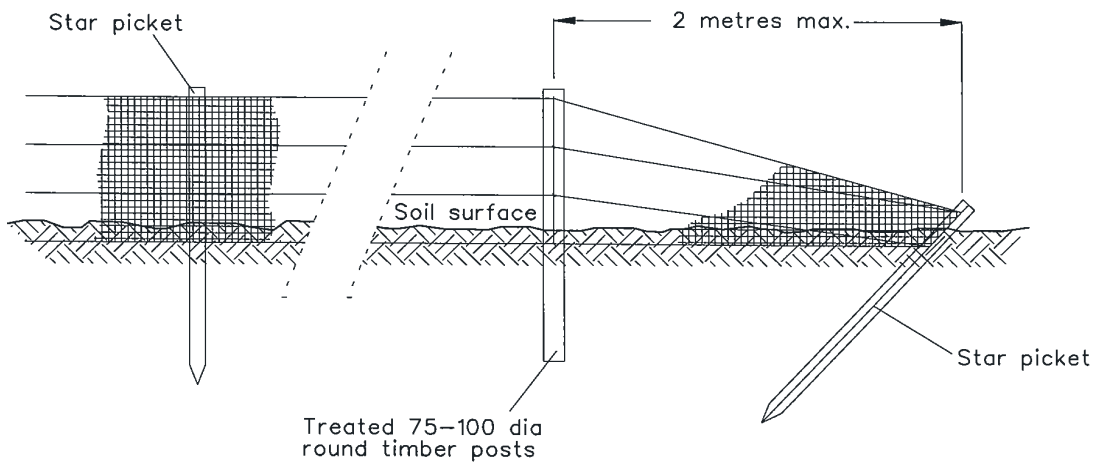
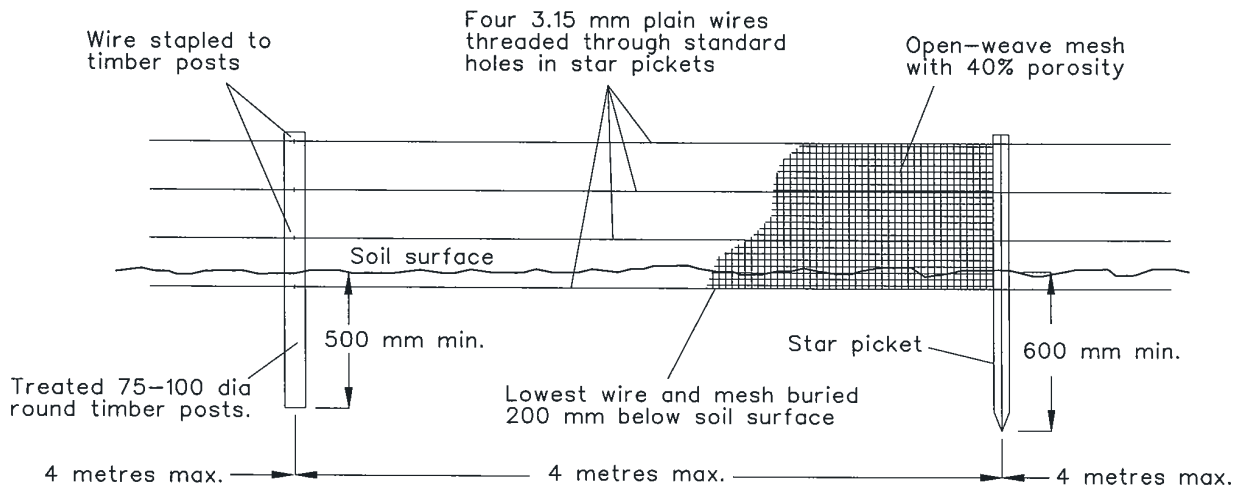
- (a) This section has been included to help decide:
 - whether or not a constructed wetland might be required on a site
 - where it might be placed
 - its approximate capacity and dimensions.
- (b) Such information might affect choice, location and design criteria for BMPs to be used during the construction phase, e.g. sediment retention basins. Further, if a wetland is required on site after a land disturbance phase, its use as a temporary sediment retention basin during the disturbance phase should be considered. This section is not intended to aid the detailed design of constructed wetlands, nor does it discuss in sufficient detail their ecology, aesthetics or economics. Information on these topics can be found in DLWC (1998).
- (c) Note that neither sediment basins nor wetlands should be built on line on watercourses.
- (d) The design criteria and construction details for constructed wetlands are still in an evolutionary phase. Consequently, several national and State-based organisations are involved in the collection of information and investigations into various alternatives for improvement in water quality. Unfortunately, their task is made difficult by the scarcity and variability of existing Australian data. The information presented here should be interpreted in this light.
- (e) Nevertheless, constructed wetlands should be considered, especially when undertaking the structure planning of new urban release areas. Their incorporation into infill developments should also be considered, although design opportunities are often limited. Constructed wetlands are most appropriate in areas where receiving water quality problems are, or are likely to result from high nutrient levels.

19. Such fences are effective to a distance of 15 times their height, assuming an acceptable soil flux of five grams per metre per second (figure 6:14). Sand and silt particles become airborne at surface wind speeds of about 10 metres per second (36 kilometres per hour) and exceed acceptable limits for airborne dust above 40 kilometres per hour.



Construction Notes

1. Strip the topsoil, level the site and compact the subgrade.
2. Cover the area with needle-punched geotextile.
3. Construct a 200-mm thick pad over the geotextile using road base or 30-mm aggregate.
4. Ensure the structure is at least 15 metres long or to building alignment and at least 3 metres wide.
5. Where a sediment fence joins onto the stabilised access, construct a hump in the stabilised access to divert water to the sediment fence



Construction Notes

1. Install the fence to the height specified in the ESCP/SWMP.
2. Cut a channel 200 mm deep along the fence line.
3. Place wire and light resistant, open-weave polymer mesh with 40 percent porosity on the prevailing wind side of fence.
4. Fasten the mesh to all wires using ring fasteners at 100 mm to 150 mm intervals on top wire and 300 mm intervals on other wires.
5. Use one 75-mm to 100-mm diameter treated round timber post every 20 metres.
6. Where star pickets are used, ensure they are fitted with safety caps.

6.4.2 Introduction

- (a) Constructed wetlands are purpose-built structures, predominantly constructed with natural materials of soil, water and biota. They mimic the desired processes and functions of natural systems to achieve specific objectives, such as retention or removal of various pollutants including nutrients, heavy metals, pathogens, hydrocarbons and colloidal particles. Typically, their design criteria aim to ensure that the levels of these pollutants after a land disturbance phase is complete are not worse than those before works began under average annual runoff conditions, especially on “greenfields” subdivisions.
- (b) The term “constructed wetland” is considered as the total entity of a project and integrated with surrounding elements of the natural environment.
- (c) Although using natural processes, constructed wetlands are not natural systems. Further, they require ongoing monitoring and management for continued performance over their design life.
- (d) Before water enters a wetland, it is desirable to:
 - (i) reduce sediment loads, particularly dispersible fines, organic debris and other floating materials;
 - (ii) attenuate stormwater flows so that the wetland's retention time is not adversely affected; and
 - (iii) attenuate stormwater velocities to ensure ecological viability, as scour and erosion can damage planted areas and re-suspend sediment leading to downstream pollution.

6.4.3 Planning

- (a) General principles that should be adopted for constructed wetland projects include:
 - (i) development with due consideration of any existing catchment or subcatchment stormwater management plan – they should be easily integrated with the local Council's stormwater planning process (see (b), below);
 - (ii) construction off-line from watercourses and, preferably, outside the riparian zone;
 - (iii) the application of a multi objective planning process (see (c), below);
 - (iv) the use of a multi disciplinary team in the planning process that includes an ecological perspective and the likely eventual owner;
 - (v) where possible, maintenance or improvement of the predevelopment water quality of the downstream receiving water body; and
 - (vi) adoption of an operation and maintenance plan for the ongoing management of the wetland that considers both the biological and physical processes.

6. Sediment and Waste Control

- (b) Consider wetlands as part of a comprehensive stormwater management system that involves the whole catchment. Therefore, constraints should be assessed on a site-by-site basis (Chapter 3). Where these constraints limit opportunity for construction of wetlands at a particular site, consideration should be given to the control of pollution of nutrients, etc. further down the catchment (i.e. in a regional wetland).
- (c) Constructed wetlands should be designed to meet multiple objectives to lengthen their effective life span and improve community usage of the area. Multiple objectives include:
- water quality improvements for various parameters
 - wildlife habitats
 - flood mitigation
 - passive recreation
 - visual amenities (landscape features)
 - water supply (i.e. park irrigation)
 - educational and research value.
- (d) Use of constructed wetlands and their surroundings for active recreational purposes should be dependent on an assessment of the risk to human health and of the potential for vandalism. The DEC does not recommend water-based activities or fishing unless contaminants in the waters meet the relevant national water quality criteria (ANZECC, 2000 and Dunkerley, 1995). Note that birds can be a major source of faecal contamination, creating conflict between water quality and habitat objectives.
- (e) Constructed wetlands for stormwater management are usually within the urban residential environment. Therefore, the local community often has a personal stake, particularly where they are to be retrofitted into an existing area. As a result, best management practice should include a community involvement program incorporating community awareness, consultation and, perhaps, participation (Brown, *et al.*, 1996). Community involvement programs can:
- engender community support and ownership for projects
 - help incorporation of community wishes and concerns in the planning and design phases
 - provide community education on environmental issues.
- (f) Generally, the use of wetlands during the construction phase should not be necessary – during this phase, control of sediment pollution is the major issue. Control of pollution of materials other than sediment usually only becomes necessary after landscaping has started and traffic levels have increased (i.e. in the landscaping and post development phases). However, commissioning wetlands during the construction phase might be convenient if sediment pretreatment is provided.

6.4.4 Wetland Design

Configuration

- (a) Where practicable, water entering wetlands should be relatively free of sediment. Pretreatment for sediment control is achieved before water enters the reed bed zone (containing emergent macrophytes) by designing a sedimentation zone. The sedimentation zone or sediment forebay removes coarse sediments from the water column through settling.
- (b) Wetlands should be constructed only as offline systems. These are built outside the main flow channel, usually being fed by very small catchments where the drainage system is not of "watercourse" status. In some cases, a diversion structure that allows runoff from large storm events to bypass the system can be considered, but these are problematic in terms of maintaining the connectivity of the watercourse. Online systems built within the flow channel are not appropriate because all runoff flows through them and, consequently:
- their integrity can be damaged in large storm events
 - they interrupt the stream or continuum, including the hydrology and the hydraulics, sediment transport and geomorphic processes
 - they interrupt the wildlife corridor
 - they replace a riparian/aquatic habitat with a wetland habitat.



Chapter 7

SITE STABILISATION

7. Site Stabilisation

7.1 Introduction

7.1.1 Background

- (a) Stabilisation can be achieved with vegetation, paving, armouring or any other cover that protects the ground surface from erosive forces, i.e. reduces the Cfactor to an acceptable level (Appendix A). It is essential on all disturbed lands where works are complete or in temporary abeyance to mitigate sediment pollution to downslope lands and waterways. This is because potential soil loss can often be reduced to about 1 percent or less of the prestabilisation level through the application of a suitable protective cover. In addition, stabilisation can improve the operational efficiency of the complete soil and water management program, and enhance the aesthetic values of the site. Nevertheless, sediment control works are necessary on all sites until stabilisation is complete.
- (b) Sections elsewhere in these guidelines highlight the importance of giving priority to those BMPs that mitigate soil erosion in the first place rather than to those that clean up the mess downslope or at the catchment outlet. This is because the control of soil erosion is the simplest and most economical way of minimising sediment pollution.
- (c) Vegetation is an ideal and usually inexpensive method of stabilisation because it reduces soil erosion hazards by:
 - absorbing the impact of raindrops
 - reducing volume and velocity of runoff
 - binding the soil with roots
 - protecting the soil from the erosive effects of wind.
- (d) It is common practice to use annual species as a fast growing and highly effective temporary ground cover. However, these plants die within one season, providing almost no residual surface protection after about six or eight months. Where protection is required beyond six or eight months, using a mixture of perennial and annual species is best. While the perennial species are usually slower to establish, they will grow under the annual species and succeed them to provide a permanent surface protection.
- (e) Effective revegetation is possible only where the factors necessary to promote and sustain plant growth levels are adequate, including sunlight, temperature, soil fertility and structure, and moisture levels.
- (f) Where land disturbance activities occur in riparian zones or watercourses, prepare a separate *Vegetation Management Plan* (Appendix I). This plan is to cover all disturbed lands to at least 10 metres beyond the works. It should address revegetation, bush regeneration and weed control. It should ensure that previously stored topsoil is respread over disturbed lands and the litter layer is restored. Any imported topsoil must be weed free.

-
- (g) If non indigenous plants are to be used as a temporary measure in natural areas, sterile hybrid species are preferred. Invasive species, such as Kikuyu and Rhodes Grass should not be used if not already common in the immediate vicinity.

7.1.2 General Principles

- (a) Where practicable, schedule the land disturbance program so that the time from starting activities to completion of the final rehabilitation program is less than six months. Special erosion and sediment control measures should be considered where such staging of land disturbance activities is not possible. Here, rehabilitation is defined two ways, depending on the local rainfall erosivity:
- (i) In periods of expected low rainfall erosivity during the rehabilitation period, achieve a C-factor of less than 0.15 and keep it there by vegetation, paving, armouring, etc.^[1] Low rainfall erosivity is a month with an erosivity of less than 100. The erosivity for a month at a location is calculated by:
R-factor X percentage of annual EI occurring per month (Table 6.2 – derive the zone from figure 4.9).^[2]
 - (ii) In periods of moderate to high rainfall erosivity during the rehabilitation period, achieve a C-factor of less than 0.1 and set in motion a program that should ensure it will drop permanently, by vegetation, paving, armouring, etc. to less than 0.05 within a further 60 days. Of course, local water restrictions might affect this in drought times.
- (b) In addition, schedule works above the 2-year ARI flood level so that the duration from the conclusion of land shaping to completion of final stabilisation is less than 20 working days. Where practical, phase works so that:
- (i) minimal lands are exposed to the forces of soil erosion at any one time; and
 - (ii) site stabilisation measures are progressively installed throughout the development phase.
- (c) However, where works are within the 2-year ARI flood level, ensure that the C-factors are higher than 0.1 only when the 3-day forecast suggests that rain is unlikely. In this case, management regimes should be established that facilitate rehabilitation within

1. C-factors of 0.15 can be achieved in various ways as shown at Appendix A, note especially figure A5, Table A3 and Table A4. For example, figure A5 shows that:
(i) A C-factor of 0.15 can be achieved with about 30 percent ground cover where the soils have not been disturbed recently and 50 percent cover where they have been disturbed (as at most construction sites);
(ii) A C-factor of 0.05 can be achieved with about 55 percent and 70 percent cover on undisturbed and disturbed soils respectively.

2. Fortnightly EI data are available for some locations in New South Wales (Rosewell and Turner, 1992) (Table 7.1) and monthly data in Queensland (Rosenthal and White, 1980). Monthly estimates are available for some locations in South Australia (Yu and Rosewell, 1996) and Western Australia (McFarlane *et al.* 1986). A method for estimating half monthly values of erosivity from monthly data is provided by Renard *et al.* (1997).

7. Site Stabilisation

24 hours should the forecast prove incorrect. Of course, this assumes that the regular suite of BMPs is installed as outlined elsewhere in these guidelines.

- (d) While C-factors are likely to rise to 1.0 during the work's program, they should not exceed those given in Table 7.1.

Table 7.1 Maximum acceptable C-factors at nominated times during works.

Lands	Maximum C-factor	Remarks
Waterways and other areas subjected to concentrated flows (Section 5.2.3), post construction	0.05	Applies after 10 working days from completion of formation and before they are allowed to carry any concentrated flows. Also, note the requirements of Table 5.1 (Note: a C-factor of 0.05 can be achieved various ways, including with about 70% groundcover. See Appendix A, especially figure A5 and Tables A3 and A4)
Stockpiles (Section 4.2.2), post construction	0.10	Applies after 10 working days from completion of formation (Note: a C-factor of 0.10 is achieved with about 60% groundcover)
All lands, including waterways and stockpiles during construction	0.15	Applies after 20 working days of inactivity, even though works might continue later (Note: a C-factor of 0.15 can be achieved various ways, including with about 50% groundcover. See Appendix A, especially figure A5 and Tables A3 and A4)

- (e) Successful revegetation of lands requires:

- availability of acceptable soil materials
- correct site preparation
- selection of the most suitable establishment technique
- selection of appropriate plant species, fertiliser(s) and ameliorant(s)
- application of sufficient water for germination and to sustain plant growth if rainfall is insufficient
- an adequate maintenance program.

Proper investigation of each of these matters on a site-specific basis is usually required.

-
- (f) Investigate areas not satisfactorily revegetated to determine the reason for failure. Then undertake appropriate remedial action, including replacing any lost topsoil and resowing the site.
 - (g) Maintain any erosion and sediment control measures until all earthworks are completed and the site rehabilitated. Where appropriate, remove soil conservation structures as the last activity in the site stabilisation program.

7.2 Revegetation: Lands Subjected to Sheet Flow

7.2.1 Introduction

- (a) On lands subjected to sheet flow, consider revegetation programs over two stages:
 - (i) Primary revegetation, which normally does not include native species and is designed to reduce the erosion hazard to an acceptable level rapidly (figure 7.2); and
 - (ii) Secondary revegetation, which might follow to create an aesthetically more pleasing environment through natural or artificial addition of permanent endemic/native species.^[3]
- (b) The landscape analysis for the site will identify a suitable strategy for revegetation, reflecting a specific theme such as mown grass, bushland regeneration, etc.

7.2.2 Primary Revegetation

- (a) Primary revegetation usually includes the use of exotic species,^[4] in particular pasture grasses.^[5] In most cases:
 - (i) use annuals where a quick, temporary cover is required (for up to about six months), and perennials for long term protection; and
 - (ii) use warm season species where summer rainfall is dominant, and cool season species where winter rainfall is dominant and/or winters are cold.

-
- 3. Primary revegetation might be omitted where the erosion hazard has been brought under control through use of mulches and/or various fabrics (Section 7.4.1). Exercise care in ensuring that:
 - materials are not toxic to the desired plant species
 - they are maintained until the secondary species are producing their own mulch (can be three to five years).
 - 4. This recommendation does not hold in bushland areas if the use of exotic species is regarded as undesirable.
 - 5. Exotic pasture species are preferred for primary revegetation because they are more easily established, provide rapid cover, and root growth quickly binds the soil surface. In addition, the seed is commercially available, seed viability is usually high and sowing methods are relatively simple. Legumes, in spite of the beneficial addition of nitrogen to the soil, are rarely used in urban revegetation programs because of their specialised management requirements.

7. Site Stabilisation



Figure 7.1 Unsatisfactory site stabilisation has resulted in substantial quantities of sediment leaving the site

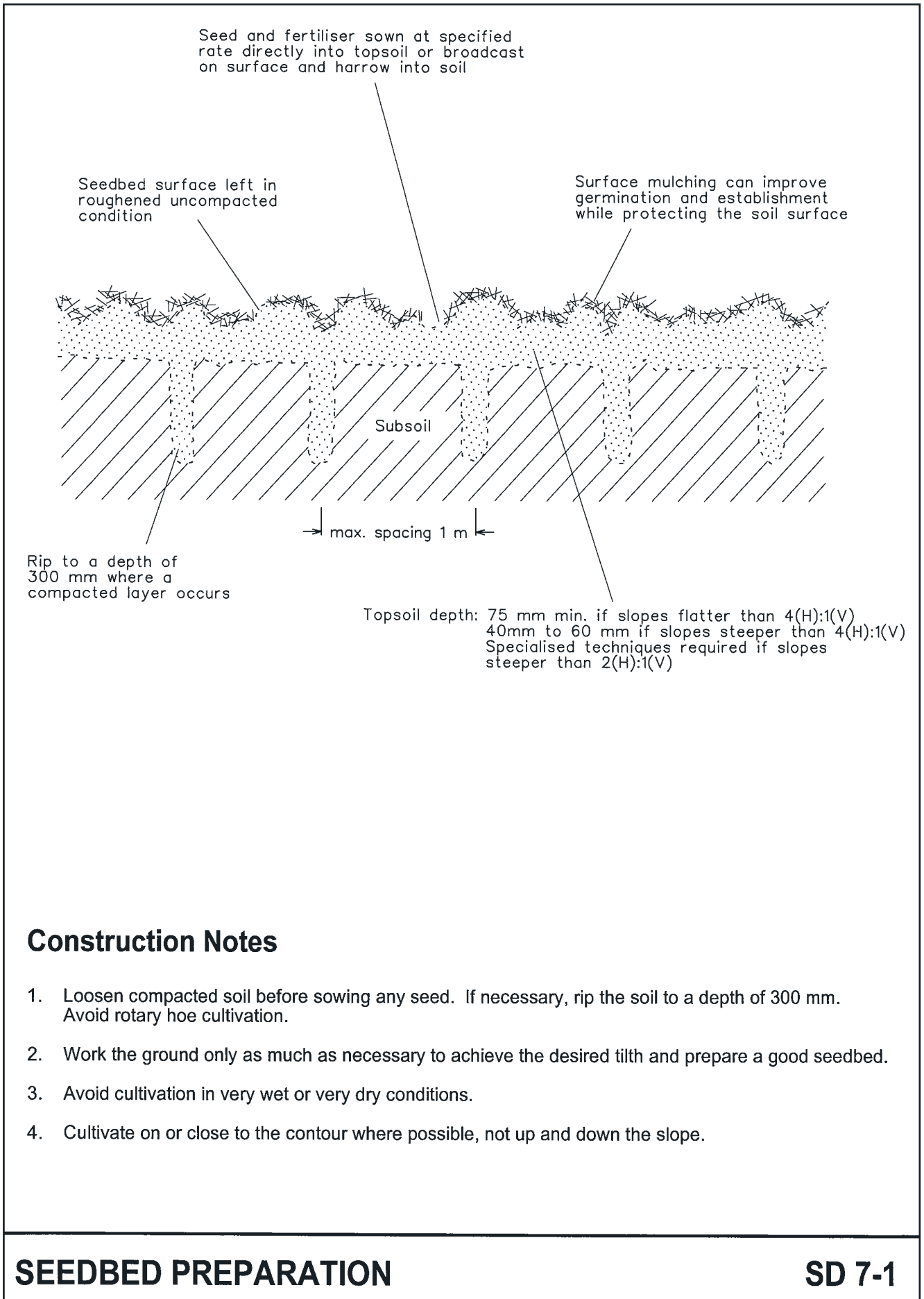


Figure 7.2 Primary revegetation of an earth batter with straw mulching (Section 7.4.1). Notice the sediment fence and barrier mesh to minimise soil erosion and sediment pollution

In the Sydney Region, Appendix G might help in the choice of plant species, fertilisers and ameliorants. Elsewhere, seek advice from local seed merchants or appropriate government departments for listings of species, sowing rates and fertiliser requirements suitable for rehabilitation.

- (b) As the physical and chemical characteristics of many subsoil materials inhibit the establishment of plants, respreading of topsoil (Section 4.3) over the disturbed area is recommended. Avoid incorporation of subsoil material into the topsoil.
- (c) Where practical to do so, a seedbed should be cultivated before sowing seed (Standard Drawing 7-1). This should include deep ripping to at least 300mm.
- (d) Where possible, ensure any cultivation of the soil is parallel to the contour.
- (e) Plants can be established (figure 7.3) by:
 - (i) broadcasting, particularly on very small areas (<one hectare) or lands that are inaccessible to conventional implements;^[6]
 - (ii) conventional implements^[7] including direct drilling or sod seeding to a depth of about 10 mm to 15 mm;^[8]
 - (iii) laying turf such as couch or kikuyu, particularly where immediate vegetative cover is required for stabilisation or aesthetic reasons; and^[9]
 - (iv) hydraulic seeding, especially on steep or inaccessible areas (figure 7.2).

-
6. Add sand to the seed to help achieve an even spread. Where grasses are being established, harrow the surface immediately after the seed and fertiliser have been applied. With the establishment of bushland plant species, undertake the harrowing first.
 7. Use of conventional implements is usually the most cost-effective method of establishing plants from seed. Plants with small seeds, grasses in particular, establish on a fine seedbed best. However, a relatively rough seedbed might be required where the soil is dispersible or the erosion risk is high (e.g. on Soil Loss Classes 5 to 7 lands). It can be formed by scarifying to a depth of about 50 mm to 75 mm. A rough seedbed is less likely to "surface seal" and will absorb moisture more readily (SD 7-1).
 8. These methods are preferred and have three advantages:
 - fertiliser is placed below the soil surface reducing the possibility of it being washed into waterways
 - precision planting of seed and fertiliser is achieved (if appropriate)
 - higher germination rates usually occur.
 9. Turf should be:
 - placed on a bed of fertilised topsoil of a minimum depth of 75 mm
 - laid parallel to the contour on sites with steep slope gradients
 - normal to direction of flow in waterways
 - under or over a pegged artificial mesh (e.g. a light polypropylene, UV stabilised mesh with about 20-mm openings) in areas of very high water velocity
 - rolled or tamped immediately as it is laid
 - where necessary, pegged to the soil at 1 to 2 metre centres, e.g. with 4 mm (No. 8 gauge) wire approximately 200 mm in length
 - watered immediately to enhance establishment
 - watered regularly for the first seven days or as required to effect establishment
 - mowed as required under the maintenance contract for the site.



Construction Notes

1. Loosen compacted soil before sowing any seed. If necessary, rip the soil to a depth of 300 mm. Avoid rotary hoe cultivation.
2. Work the ground only as much as necessary to achieve the desired tilth and prepare a good seedbed.
3. Avoid cultivation in very wet or very dry conditions.
4. Cultivate on or close to the contour where possible, not up and down the slope.

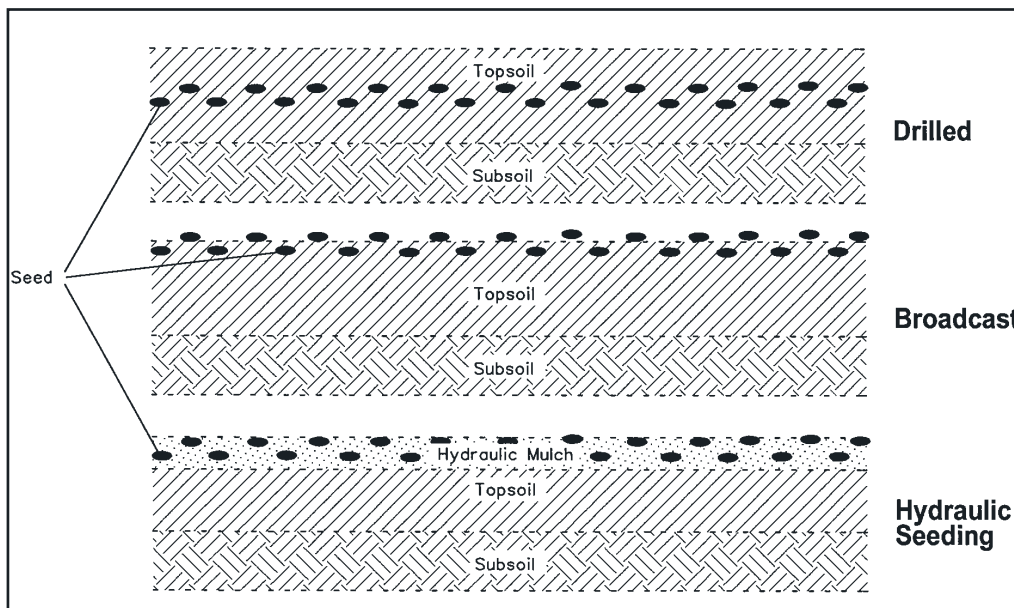


Figure 7.3 Seed placement with different sowing methods

- (f) In addition to identifying the best species mix, establishing the best fertiliser and ameliorant mix for plant growth is essential.^[10]
- (g) Establishment of plants should not be attempted during hot, dry periods unless sufficient water can be applied artificially.

7.2.3 Secondary Revegetation

- (a) Secondary revegetation normally follows the primary revegetation program, although species can be established at the same time.
- (b) Include native species propagated to enhance ecological values and create an aesthetically pleasing environment after the soil erosion hazard has been reduced. Near watercourses, use native plants propagated from seeds collected from the local area.
- (c) Establishment can be from seed, tube stock or invasion from the surrounding bushland. Where possible, choose species that will rapidly provide an adequate mulch to protect the ground surface from the forces of erosion.^[11]

10. For optimum establishment and growth of exotic species, many soils require ameliorants to alter the soil pH and/or improve the soil structure. Details on specific requirements can be obtained from appropriate government departments or through laboratory testing of the soil materials.

11. Most exotic pasture species have difficulty competing with taller native plants when more than about 70 percent shading occurs.

7. Site Stabilisation

- (d) Effective establishment of native species, particularly those endemic to the region, usually requires an environment where the ongoing nutrient and moisture regimes are close to the natural status.^[12] Avoid the use of fertilisers and/or ameliorants except in situations where they are likely to leach from the soil relatively quickly, and any modified conditions are unlikely to be retained. These factors are often critical when reestablishing or retaining native bushland downslope from an urban subdivision, for example, where drainage from well-tended gardens can create an environment where exotic plants can compete effectively with native plants.
- (e) Where primary revegetation is omitted in bushland areas, protect the ground surface against erosion with mulch or a biodegradable blanket until adequate mulch is produced naturally by local plants (Section 7.4.1). This can also reduce weed competition, depending on depth or thickness.

7.3 Revegetation: Lands Subjected to Concentrated Flow

7.3.1 Introduction

- (a) While most erosion control techniques are satisfactory under sheet flows conditions (e.g. wood chip mulches), special measures are essential under concentrated flow conditions. Some of these are identified in Table A4 (Appendix A). These special measures should be considered on all lands within the 10-year ARI flood level.
- (b) Generally, use plants as a protective measure to bind the surface together. This is especially important in waterways because:
 - (i) their growth pattern usually results in lower water velocities (therefore, increased time of concentration, lower peak flows and fewer outlet problems);
 - (ii) they can filter pollutants from the water, including sediment and nutrients; and
 - (iii) usually, they are aesthetically more pleasing than non vegetative materials.
- (c) In most situations, use only non invasive exotic species for revegetation of lands subjected to concentrated water flow because:
 - (i) seed is more likely to be available in commercial quantities when required; and
 - (ii) they are more effective than native species in binding the soil material and reducing the soil erosion hazard.

12. Most native species have evolved adaptations to a harsh environment that often include soils deficient in nutrients, and/or that have extremes of pH, and/or that have extreme fluctuations in available moisture. Exotic species usually do not grow well in such environments without modification to one or more of these factors.

-
- (d) Do not use reinforced turf near watercourses unless the mesh is biodegradable. If exposed, it can:
- be a threat to wildlife
 - lead to mass failure of the turf if snagged.

7.3.2 Vegetation Establishment

- (a) Establishment of plants on lands subjected to concentrated flows can be undertaken using similar methods to those described in Section 7.2.2 for Primary Revegetation.
- (b) Areas of frequent channelised flow are best stabilised with reinforced turf.
- (c) Where water flow is saline or relatively continuous, suitable species and channel treatment should be planned to avoid establishment failure and channel damage.
- (d) Permanently established vegetated waterways should provide protection to the soil against the erosive action of flowing water as described in Section 5.3.3(c) and Table 5.2 in the design storm event (Section 2.3.1 (e)).

7.4 Special Considerations

7.4.1 Aids to Establishment

- (a) Mulches:
- usually provide a protective cover for the soil surface to prevent erosion of loose soil/fertiliser particles (Table A3, Appendix A), especially on lands with moderate to steep slopes, and help establishment of plants by reducing evaporation and increasing water infiltration;
 - should be 20 mm to 40 mm thick – thicker mulches (75 mm to 100 mm) inhibit germination and can be applied to control weeds; and
 - in bushland areas, should be:
 - comprised of local native species where available
 - maintained until the vegetative cover can provide adequate protection against the erosive forces (figure 7.4; cf. figure 7.3).
- (b) Straw mulches:
- are particularly effective where soils are dispersible, on sites with a high soil erosion hazard, or where soil moisture is likely to be inadequate for successful plant establishment (e.g. batters);
 - such as wheat or oaten straw are suitable at about 250 bales per hectare, other than in bushland areas, and should be dry when applied and have a low leaf content;

7. Site Stabilisation

- (iii) should be free of non endemic seed in bushland areas; and
 - (iv) should be sprayed with an anionic bitumen emulsion at 2,500 litres per hectare or other suitable binder.
- (c) Brush mulches:
- (i) are preferred on lands where regeneration of native plants is wanted as it can provide an additional source of seed — of course, using endemic plant materials;
 - (ii) should be applied parallel to the contour; and
 - (iii) should be stockpiled with care since spontaneous combustion can occur.
- Care should be exercised to ensure the cutting of local brush does not damage adjoining ecosystems. Brush should only be taken from approved cleared areas.
- (d) Wood chip mulches are useful for weed control. Mulched street tree loppings and pine flakes are preferred from an ESD standpoint. Processed hardwood is ESD acceptable if taken from forest trimmings and not from primary forest timber trees.
- (e) Biodegradable blankets (see Appendix D), including jute mesh and plant fibre matting, are alternatives to mulches and particularly useful in areas of high water concentration^[13] Jute mesh should be sprayed with an anionic bitumen emulsion at about 1 to 3 litres per square metre for extra stability in areas where concentrated runoff might occur.
- (f) Bitumen emulsion can be applied by itself as mulch and is suitable for areas where cool season plants will be sown and soil moisture is not a major constraint to plant establishment.
- (g) Hydroseeding is particularly useful in the higher rainfall, coastal areas. Supplementary watering is advisable if weather conditions are unfavourable for germination or establishment. Include polymers or bituminous binders on steep lands. ^[14]

13. They can provide temporary protection to earth drains intended to be removed or upgraded within six months, or grassed waterways that have only recently been established from seed or runners (figure 4.4).

14. Hydroseeding involves the mixing of seed, fertiliser and a paper or wood pulp with water to form a slurry sprayed over the area to be revegetated. The seed generally sticks to the pulp that improves the microclimate for germination and establishment. Hydromulching is a different operation to hydroseeding in that it uses a higher rate of cellulose fibre to act as mulch by itself. Hydroseeding and straw mulching are normally concurrent operations and achieve superior results to hydromulching.



Figure 7.4 Lack of site stabilisation of a drainage line following installation of services



Figure 7.5 Effective mulching of a service easement using local brush

7. Site Stabilisation

7.4.2 Saline Areas

- (a) A Western Sydney Salinity Code of Practice has been prepared by the 13 relevant Councils through the Western Sydney Salinity Working Party. This is a useful document to help all those working in saline areas, but especially in western Sydney and should be consulted wherever salinity is expected, especially on soils derived from marine sediments such as the Wianamatta Shales. Read the Code together with the Salinity Hazard Map prepared by the Department of Infrastructure, Planning and Natural Resources.
- (b) Salinity occurs when salts found in the soil or groundwater mobilise, allowing capillary rise and evaporation to concentrate salts at the ground surface. Usually, such movements are brought about by changes to the natural water cycle through:
- artificially adding water to the watertable, causing it to rise
 - removing deep-rooted vegetation
 - impeding subsoil drainage.
- (c) Some developers in western Sydney have unwittingly contributed to the problem by following water-sensitive urban design principles developed in other places where salinity is not a problem. Specifically, they have followed procedures designed to encourage excessive infiltration to the watertable without a full appreciation of the consequences. Infiltration measures, while encouraged, should incorporate a subsurface drain and liner where infiltration to groundwater might exacerbate salinity problems.
- (d) If the watertable within the root zone becomes saline, the vegetative cover is likely to die and expose the soil to erosive forces. Salinity also can affect built infrastructure, affecting detrimentally concrete, bricks and metal, and resulting in structural damage and unnecessary repair costs.
- (e) Salinity problems are usually overcome by lowering the watertable through:
- (i) reducing infiltration rates, e.g. lining waterways with impervious materials
 - (ii) improving drainage, e.g. installation of subsoil drains;
 - (iii) planting deep-rooting salt-tolerant plants to act as “pumps”.
- (f) Choose plant species for rehabilitated lands that are more tolerant of any likely high salt levels.^[15]
- (g) Where necessary, implement building controls and/or other engineering responses to salinity problems.

15. Including (from highly salt tolerant to moderately tolerant) puccinellia, tall wheat grass, couch, Wimmera rye grass, Rhodes grass, phalaris, strawberry clover and lucerne (Hamilton and Lang, 1978).

7.4.3 Maintenance

- (a) Maintenance (Chapter 8) of both soil conservation works and revegetated areas is an essential part of any rehabilitation program and should be addressed in the *ESCP/SWMP*. It can include:
- (i) periodic application of water, especially in the first seven days from establishment on turfed areas and/or in hot, dry weather;
 - (ii) further application of seed and fertiliser in areas of minor soil erosion and/or inadequate vegetative establishment; and
 - (iii) regular mowing, especially in waterways, to control weeds and to maintain a cover that does not impede flows and cause flooding or accumulation of pools of stagnant water.
- (b) Establish salt-tolerant species or apply other corrective measures where bare areas arise because of salinity in surface or ground water and soils.
- (c) Control excessive vegetative growth through mowing, slashing or judicious use of herbicides. Do not mechanically grade vegetated waterways and road verges unless part of a further stabilisation program.^[16]

16. Set mower height no lower than 75 mm above the ground surface.



Chapter 8

MAINTENANCE

8.1 Introduction

- (a) Proper maintenance of soil and water conservation works plays a vital part in their management and operation. After a storm event, the effectiveness of the established controls can be readily seen with any shortcomings and damage.
- (b) Always keep the potential hazards of soil erosion at the site and consequent sediment pollution to downslope areas to a minimum. This is always important, but especially before times when works are unlikely to proceed for any reason. Accordingly, the site manager should check the operation of all soil and water management works each day and initiate repair or maintenance as required.
- (c) Current legislation requires the quality of run off water leaving each site to be of an acceptable standard. Penalties apply where pollution to downslope lands and waterways occurs. The law does not recognise:
 - whether or not the site is difficult
 - problems that might be encountered in implementing the plan
 - whether or not you are familiar with good soil and water standards.
- (d) An effective maintenance program should include ongoing modification to any *Plan* as development progresses. This is because such *Plans*:
 - (i) are usually based on a specific landform shape. However, as development proceeds, changes occur in slope gradients and drainage paths with their exact form frequently unpredictable before works begin; and
 - (ii) assume the site development works will proceed according to a specific set of engineering plans. However, these are often modified as part of the development process.
- (e) Address ongoing maintenance of all permanent soil and/or water control structures in the planning phase. This is likely to be relevant, especially for some long-term works, where authority for maintenance passes from the developers/site operators and their contractors to, e.g. the local consent authority.

8.2 Maintenance Program

- (a) Empty bins for concrete and mortar slurries, paints, acid washings, lightweight waste materials and litter at least weekly and otherwise as necessary. Dispose of any waste in an approved manner.
- (b) Ensure proper drainage of the site. To this end:
 - (i) clean any catch drains, diversion banks, table drains, berm drains and drop-down structures (including inlet and outlet works) that have become

-
- blocked through sediment pollution, sand/soil/spoil being deposited in or too close to them, breached by vehicle wheels,^[1] etc.;
- (ii) check that drains are operating as intended (Section 5.4), especially that:
 - no low points exist which can overtop in a large storm event^[2]
 - areas of erosion are repaired (e.g. lined with a suitable material^[3] and/or velocity of flow is reduced appropriately through construction of small check dams or installing additional diversions upslope);
 - (iii) construct small additional earth diversions^[4] at distances of less than 80 metres across the works to keep slope lengths short and dispose of water without causing channel erosion; and
 - (iv) regularly clean out sediment trapped behind sediment fences and other traps.
- (c) Ensure removal of any sand/soil/spoil materials placed closer than 2 metres from hazard areas, such as waterways, gutters, paved areas and driveways. Provide protection to receiving waters from any such materials placed more than 2 metres from hazard areas by implementing the required soil and water management practices.
- (d) Check that rehabilitated lands have established sufficient ground cover to reduce the erosion hazard effectively and initiate repair as appropriate (Chapter 7). Note that:
- (i) periodic applications of water are essential, especially in the first seven days from establishment on turfed areas and/or in hot, dry weather; and
 - (ii) further applications of seed and fertiliser might be necessary in areas of minor soil erosion and/or inadequate vegetative establishment.
- Establish salt-tolerant species or apply other corrective measures where bare areas arise because of salinity in surface or ground water.
- (e) Control excessive vegetative growth through mowing,^[5] slashing or judicious use of biodegradable herbicides. This is especially important with waterways to control weeds and to maintain a cover that does not impede water flow, thereby causing flooding or accumulation of pools of stagnant water. Do not grade existing waterways and road verges unless part of a further rehabilitation program.
- (f) Do not dispose of cleared vegetation by open burning on site. Preferred disposal options include chipping or mulching for future rehabilitation purposes, unless the presence of weed seed or viable vegetation parts makes this not viable. Less preferred options include transport to a landfill facility, or trench-burning using licensed equipment.

1. Redesigning any crossings to permit continued vehicle access without affecting the function of the drain might be necessary.

2. Either raise low points or, temporarily, line the downslope side with sandbags, straw bales, etc.

3. Including use of grass, plastic, geotextile, rock or concrete.

4. A single pass with a grader, constructing a diversion drain about 300 mm deep is usually adequate.

5. Set mower height no lower than 75 mm above the ground surface.

8. Maintenance

- (g) Control emission of dust from unsealed roads and other exposed surfaces, such as unprotected earth or soil stockpiles, by use of surface sealants and/or water spray carts or other appropriate equipment. Keep the surfaces moist rather than wet.
- (h) Keep all sediment detention systems in good, working condition. Ensure:
 - (i) recent works have not resulted in the diversion of sediment-laden water away from them;
 - (ii) degradable products (e.g. straw bales) are replaced as required;
 - (iii) sediment is removed if the design capacity or less remains in the settling zone;
 - (iv) retention basins on *Type C* soils have a minimum settling zone depth of at least 0.6 metres over two-thirds of the surface area when surcharging;
 - (v) water in retention basins on *Type D* soils is treated with a flocculating agent following the requirements of Section 6.3 and Appendix E if the soils at the sediment source contain more than 10 percent dispersible materials.^[6] Where basins require pumping out, the necessary dosing should occur within 24 hours of the conclusion of each storm event and the basin should be drained once suspended solids levels are less than 50 milligrams per litre, usually 36 to 48 hours later if gypsum is used. Longer or shorter treatment and dewatering periods may apply if rainfall events of duration other than 5 days has been adopted in the design of the basin;^[7] and
 - (vi) pollutants, sediment and/or waste removed from sediment basins, gross pollutant traps and trash racks are disposed in stabilised dumps where soil and water measures have been implemented to stop offsite movement of pollutants.
- (i) To determine the effectiveness of any sediment retention basins, the consent authority might require the site manager to undertake sampling and subsequent analysis of non filterable residue (NFR) concentrations of waste water. Such sampling and analysis is likely to be required periodically or for a nominated period, usually the first three months after commissioning the basins.
- (j) Dispose any pollutants removed from sediment basins in areas where further pollution to downslope lands and waterways should not occur.
- (k) Construct additional erosion and/or sediment control works as might become necessary to ensure the desired protection is given to downslope lands and waterways, i.e. make ongoing changes to the Plan.
- (l) Maintain erosion and sediment control measures until all earthwork activities are completed and the site rehabilitated.

6. Where necessary, a suitably sized stockpile of flocculating agent should be kept onsite for the treatment of wastewater impounded in sediment retention systems.

7. Place a marker peg within each sediment retention basin to indicate the design capacity of the sedimentation zone and level above which capacity is available in the settling zone for containment of runoff.

(m) Temporary soil conservation structures/measures are to be removed and surfaces restored to the final landform as the last activity in the works program. Then, vegetative rehabilitation of these areas can begin following the requirements of the site rehabilitation/landscaping plan. First liaise with the relevant local government body where works:

- are likely to continue in the catchment and are not associated directly with the development
- include sediment retention basins.

This is to determine whether the local consent authority is prepared to take over control and responsibility for any such structures. Ongoing maintenance of sediment basins can be desirable where later works in the catchment not associated with this development are likely to produce sediment. If the local consent authority does agree to take such responsibility, the developer/site operator is expected to ensure that they are in good working order and design capacity is available.

(n) A self-auditing program should be established based on a Check Sheet (Table 8.1) developed for the specific site – note that every site will be different. A site inspection using the Check Sheet should be made by the site manager:

- at least weekly, and
- immediately before site closure, and
- immediately following rainfall events that cause runoff.

Undertake the self-audit by:

- walking around the site systematically (e.g. clockwise)
- recording the condition of every BMP employed
- recording maintenance requirements (if any) for each BMP
- recording the volumes of sediment removed from sediment retention systems, where applicable
- recording the site where sediment is disposed
- forwarding a signed duplicate of the completed Check Sheet to the project manager/ developer/ site operator for their information.

In particular, inspect:

- locations where vehicles enter and leave the site
- all installed erosion and sediment control measures, ensuring they are operating correctly
- areas that might show whether sediment or other pollutants are leaving the site or have the potential to do so
- all discharge points, to assess whether the erosion and sediment control measures are effective in preventing impacts to the receiving waters.

8. Maintenance

Tables 8.2, 8.3 and 8.4 are adapted from Fifield (2002b) and contain listings of suggested inspection guidelines that might apply. These listings are not intended to be complete and issues raised might vary from one site to another.

Keep a complete set of the Self-audit Check Sheets onsite and make them available to any officer of the local council, NSW DEC or other authorised person on request.

Table 8.1 Example of a Self-audit Check Sheet (part only)

Site Location:		
Date Inspected:		
Name:		
Signature:		
BMP	Condition	Remarks
Basin 1	OK	No maintenance required
Basin 2	Contains Sediment (about 30 m ³)	Instructed J. Smith to remove it and dispose at the fill site
Silt fence 1	OK	No maintenance required
Silt fence 2	Breached for access	Instructed D. Brown to repair it
Etc.		

Table 8.2 Guidelines that might apply to inspection of structural measures

Sediment retention basins	
	<ul style="list-style-type: none"> · has sediment settling zone sufficient capacity? · is the outflow structure installed as illustrated in the <i>ESCP</i> or <i>SWMP</i> ? · are the embankments protected against erosion?
Sediment filters	
Straw bales	<ul style="list-style-type: none"> · are they installed in trenches? · are they tightly abutting, with material stuffed between the bales? · are they staked? · has backfill material been placed on the upstream side?
Sediment fences	<ul style="list-style-type: none"> · is runoff water running around, below, or between the bales? · is the filter fabric buried in a trench and backfilled? · are the stakes installed correctly with proper spacing?
Continuous berms	<ul style="list-style-type: none"> · has sediment accumulated to within 300 mm of the top? · is runoff water running around, below, or between the fabric joins?
Other	<ul style="list-style-type: none"> · have the berms been installed correctly? · is the fabric adequately stapled? · are barriers causing local flooding problems?
Check dams	
Straw bales	<ul style="list-style-type: none"> · are the bales staked and tight with each other? · have the bales been installed in a trench and backfilled? · will water be forced to run over a centre bale and not around the end bales?
Rock	<ul style="list-style-type: none"> · is the ground below where water flows over the bales eroding? · is the correct-size rock being used? · will water flow over the middle instead of around the edges? · Has movement of the rock occurred?
Drains/inlet protection	
Straw bales	<ul style="list-style-type: none"> · are the bales staked and tight with each other? · have the bales been installed in a trench and backfilled? · will water be forced to run over a centre bale and not around the end bales?
Filter fabric	<ul style="list-style-type: none"> · is the ground below where water flows over the bales eroding? · is the filter fabric buried in a trench and backfilled? · is it staked correctly with proper spacing? · has sediment accumulated to within 300 mm of the top?
Inserts	<ul style="list-style-type: none"> · is runoff water running around, below, or between the fabric joins? · has the insert been installed correctly? · will the insert prevent runoff water from entering the stormwater system? · has sediment filled the structure? When will the sediment be removed?

8. Maintenance

Table 8.3 Guidelines that might apply to inspection of non-structural measures

Diversion and containment banks	<ul style="list-style-type: none"> · are they protected against erosion? · have they been constructed to control and divert anticipated flows? · should the bottom be lined with any material to prevent erosion?
Slope drains	<ul style="list-style-type: none"> · will runoff water be diverted into the pipe? · does sufficient protection exist to prevent failure of piping? · is the pipe anchored? · does erosion protection exist where water charges? · are they functioning in the manner they were designed?
Staging of construction	<ul style="list-style-type: none"> · does all the ground need to be disturbed? · how much land is being disturbed and how much can remain in vegetation?
Planting of perennial seed	<ul style="list-style-type: none"> · are drill marks evident that are parallel or perpendicular to land contours? · has seed tag been checked and the mixture verified? · if seed was applied hydraulically, how much was used? · if seed was broadcast, was the ground raked? · what time of year was the seed planted? · are weeds becoming established?
Planting of temporary, nursery, or cover crop	<ul style="list-style-type: none"> · what type of seed was used? · how long will the vegetation be in place before planting perennial grass? · when was the seed planted?
Dry/hydraulic mulch	<ul style="list-style-type: none"> · does the mulch cover 80-100% of the bare ground? · if dry mulch is applied, how is it held in place? · has wind removed the dry mulch and is this a problem?
Soil binder	<ul style="list-style-type: none"> · what type of material was used? · when was it applied? · does the material still control erosion?
Hillside protection by RECP	<ul style="list-style-type: none"> · is the material properly installed at the top? · are sufficient staples used? · does the material overlap along the edges? · does the material need to be repaired?
Channel protection by ECBS, TRMS, and C-TRMS	<ul style="list-style-type: none"> · is the material properly installed at the top? · are sufficient staples used? · is the material properly stapled or trenched along the edges? · should a rock check structure be installed on top of the material?

Table 8.4 Guidelines that might apply to the control of wind-borne particles

Soil roughening	·	how deep are the furrows?
	·	are the furrows filling up with soil?
	·	are the furrows perpendicular to the prevailing wind?
Wind barriers	·	have they been installed perpendicular to what is accepted as the prevailing wind direction?
	·	are they in need of repair or replacement?
	·	have the structures been placed where maximum deposition of wind-borne particles can occur?
Vegetation	·	is the ground bare?
	·	how tall and/or dense is the vegetation?
Hydraulic mulch/soil binder	·	has sufficient material been applied?
	·	how long will the material be expected to control erosion?
	·	has the material broken down, and is it still effective?

8.3 Post Construction Issues

- (a) Whereas this manual deals in the main with the construction phase, there are some post construction issues that should be considered to ensure the construction phase is concluded in a responsible manner. This will apply to both subdivision works and building works.
- (b) Issues to be considered include:
- (i) Ensure revegetation and planting areas have been properly established, including areas occupied by all temporary erosion and sediment control structures.
 - (ii) Liaise with the local consent authority to determine whether the ownership and ongoing responsibility for any structures (e.g. sediment basins) can transfer to it.
 - (iii) Remove all treatment techniques or structures that are no longer required in a way that complies with:
 - safety standards
 - consent conditions
 - requirements that sediment and other materials are disposed in an approved manner
 - sound construction principles.
 - (iv) Ensure site access is returned to its original condition or approved final layout depending on site-specific circumstances.
 - (v) Transfer of any temporary works to permanent works. This might include the removal of sediment from a sediment basin that is to be transferred to the control of the local consent authority as either a permanent sediment basin or upstream section of a permanent wetland.



Chapter 9

URBAN

CONSTRUCTION SITES

9. Urban Construction Sites

9.1 Preamble

Information of particular relevance to urban construction sites is contained in this Chapter. It highlights relevant issues contained elsewhere in Chapters 1 to 8 of these guidelines that should be consulted. Specialised information relating to quarries and open-cut mining sites, waste disposal sites, major road and highway construction, access tracks in bushland, and installation of services is in Volume 2 of these guidelines.

9.1.1 Purpose, Scope and Objectives

- (a) This chapter helps land developers to apply the information contained in Chapters 1 to 8 of this document to urban development activities in New South Wales where more than 250 square metres will be disturbed. While it focuses on both the subdivision and subsequent building construction stages, the information applies to all similar activities. It integrates best practice techniques to ensure that any land disturbance activities cause minimal harm to the environment, especially the receiving waters. Guidance in relation to the planning and implementation of post construction (permanent) stormwater management measures, including water sensitive urban design' techniques, is provided in *Managing Urban Stormwater: Urban Design*.
- (b) Not all relevant planning, design, construction, rehabilitation and maintenance information is contained here, but it does contain an overview of many more commonly applied practices and model plans for guidance. The intention is not to hinder individual intuitive approaches that might apply to specific situations.
- (c) All those involved in land disturbance activities should consider the relevant legislative requirements (Appendix K), Local Environmental Plans, Development Control Plans, Regional Environmental Plans and State Environmental Planning Policies before beginning the planning process.

9.1.2 Temporary Measures

- (a) Often, urban construction sites have limited space and, consequently, developing full soil and water management programs can be difficult. Despite this, measures should still be undertaken for control of pollution of waters^[1] by:
 - sediment
 - concrete slurry, acid washes, paints, solvents, adhesives
 - pesticides
 - litter.

1. Here, "waters" means any river, stream, lake, lagoon, swamp, wetlands, unconfined surface water, natural or artificial watercourse, dam or tidal waters (including the sea), or part thereof, and includes water stored in artificial works, water in water mains, water pipes and water channels, and any underground or artesian water, or any part thereof.

This is in addition to the presence of any soil and water management works put in place elsewhere by other developers to protect the subdivision stage.

- (b) Urban construction sites in fully developed, inner city areas (infill development) can provide difficulties in controlling pollution of stormwater systems. Often, avoiding destruction of the protective ground cover over the entire site is extremely difficult (figure 9.1). Works on these sites need careful management of activities to prevent sediment pollution. However, specific measures can be taken to mitigate the threat of pollution, such as:
- (i) Stockpiling materials on site where possible and containing the material with a sediment fence;
 - (ii) Covering materials with plastic sheeting, geosynthetic materials or soil binders to reduce the impact of wind and water if other protective measures are impractical;
 - (iii) Where material can only be stored on the footpath and/or road area and Council approval is received, ensuring:
 - a gutter flow bypass is provided with pipes laid in the gutter to convey water past the material
 - downstream pit protection is provided to prevent material from entering the drainage system
 - pedestrian and vehicular safety and warning devices are erected where appropriate
 - the above measures are regularly maintained.
 - (iv) Limiting the amount of material on site to that required for the tasks immediately at hand. Delivery of smaller quantities of materials will make managing the site easier;
 - (v) Ensuring all material is immediately removed from the site when practical to do so and at the completion of work; and
 - (vi) Instructing site workers on the need to prevent materials from washing or blowing into the stormwater system or elsewhere.
- (c) Other temporary site management techniques that should be applied during construction include:
- (i) advising site workers, subcontractors and delivery drivers of their responsibilities to minimise the potential for soil erosion and pollution to downslope lands and waterways;
 - (ii) where possible, requiring any staff, contractors or subcontractors to maintain all erosion and sediment control devices in good order and replacing damaged sections as appropriate;

9. Urban Construction Sites



Figure 9.1 Typical medium-density, inner-city construction site.

- (iii) placing non erodible materials (e.g. timber) in the gutter to help entry to the site ^[2]
- (iv) permitting only approved machinery for travel within watercourses and drainage lines;
- (v) where practical to do so, requiring utility groups to undertake common trenching, conduit installation and backfilling for the whole project area continuously until completion;
- (vi) ensuring all staff facilities are properly installed and maintained so that pollutants, including wash water, are not conveyed from the site in stormwater. Urge staff to use proper toilet facilities provided;
- (vii) controlling discharge of sediment and/or other pollutants from dewatering (site pump-out) activities. Polluted water may need to be treated on-site before being discharged to the stormwater system. Special care is needed where groundwater is or could be contaminated;
- (viii) providing approved bins for concrete and mortar slurries, paints, acid washes, lightweight waste and litter, and ensuring their regular clearance;
- (ix) ensuring that any poisons are applied according to their registration and instructions carried on the label (e.g. for termite control);
- (x) ensuring safeguards are in place to prevent residue paint and other chemicals from entering the stormwater system. Spray painting, high-pressure washing and

2. The placement of erodible materials (e.g. spoil) in the gutter is contrary to the Protection of the Environment Operations Act, 1997, and is not permitted.

-
- other activities that may permit airborne particles to dissipate to waterways should be carefully controlled. Use of less hazardous material is encouraged;
- (xi) applying sound material management practices in relation to the storage and handling. Sound practices include storing materials in designated locations, installing secondary containment bunds, regularly inspecting storage areas and training site personnel in correct practices. Procedures should also be established to clean up any spills correctly and considerate of the appropriate legislation, e.g. Protection of the Environment Operations Act, 1997 (Appendix K);
 - (xii) instigating responsible vehicle and equipment maintenance and servicing practices. Washing of vehicles and equipment should be restricted with off-site commercial facilities favoured. Any necessary washing on-site should be contained to specific bunded wash areas. Biodegradable detergents should be used. Care should be exercised with steam cleaning operations that might discharge pollutants to the air; and
 - (xiii) ensuring safe vehicle and equipment refuelling procedures are instigated. Fuel storage areas should be covered and spills should be prevented with proper containment areas established. Equipment leaks should be eliminated as part of a regular equipment maintenance program.

9.1.3 Permanent Measures.

- (a) Generally, permanent soil conservation measures should be carried out as part of the landscape design and specification at the conclusion of works. These should result in bringing potential soil losses to extremely low levels (<10 t/ha/yr) and ensure high levels of protection from the effects of sheet flow, concentrated flow and mass movement. They should incorporate any flood mitigation measures required by council and integrate landscape and hydraulic design to optimise stability and amenity values.
- (b) Control the erosive effects of sheet flow by:
 - (i) paving permanent driveways and parking areas as soon as possible after their construction; and
 - (ii) stabilising other areas as soon as possible after final shaping, with plants, mulches, geosynthetic materials, soil binders or similar techniques.
- (c) Rehabilitating slopes steeper than 2(H):1(V) by vegetative means is very difficult and alternate methods are usually required, particularly to control the movement of soil materials by gravitational colluvial action. However, control can be achieved in various ways, including through:
 - regular irrigation (controlled application to prevent slumping)
 - cellular containment systems

9. Urban Construction Sites

- riprap
- construction of retaining walls (using rock, or geosynthetic materials discussed at Appendix D), etc.

A qualified engineer should design any retaining wall more than 1 metre in height.

9.2 Residential Dwelling Requiring an ESCP

9.2.1 Introduction

- (a) *ESCPs* are plans showing how to minimise erosion and trap sediment resulting from minor construction or building activities. They are required on all sites where between a total of 250 square metres and 2,500 square metres are to be disturbed in urban construction programs (Chapter 2).
- (b) The complexity of *ESCPs* will vary with the nature and scale of the development, particularly the likely amount of ground disturbance. They should be “stand alone” documents, consisting of drawings and notes that can be easily understood by site personnel and the consent authority. Section 2.2 contains listings of information required on the drawings and commentary that comprise *ESCPs*.
- (c) Figures 9.2 and 9.3 show two patterns for house construction that might help guide the preparation of an *ESCP*. Of course, these drawings are not intended to cover all situations and variations from them are expected in many cases. For example, leaving the rear of many residential blocks in a vegetated condition is often not possible because of lack of space, so the entire block might need to be disturbed. Nevertheless, the footpath and adjacent blocks should rarely be disturbed and, then, only when essential, e.g. drainage works on the footpath. Where they are disturbed, they should remain in a condition of a high erosion hazard for as short a period as practicable.

9.2.2 Model *ESCP* for a Residential Dwelling

The *ESCP* Commentary:

1. Site works will not start until the erosion and sediment control works outlined in clauses 2 to 4, below, are installed and functional.
2. The ingress to and egress from the site will be confined to one stabilised point. Sediment or barrier fencing will be used to restrict all vehicular movements to that point. Stabilisation will be achieved by either:
 - constructing a sealed (e.g. concrete or asphalt) driveway to the street
 - constructing a stabilised site access, according to Standard Drawing SD 6-14

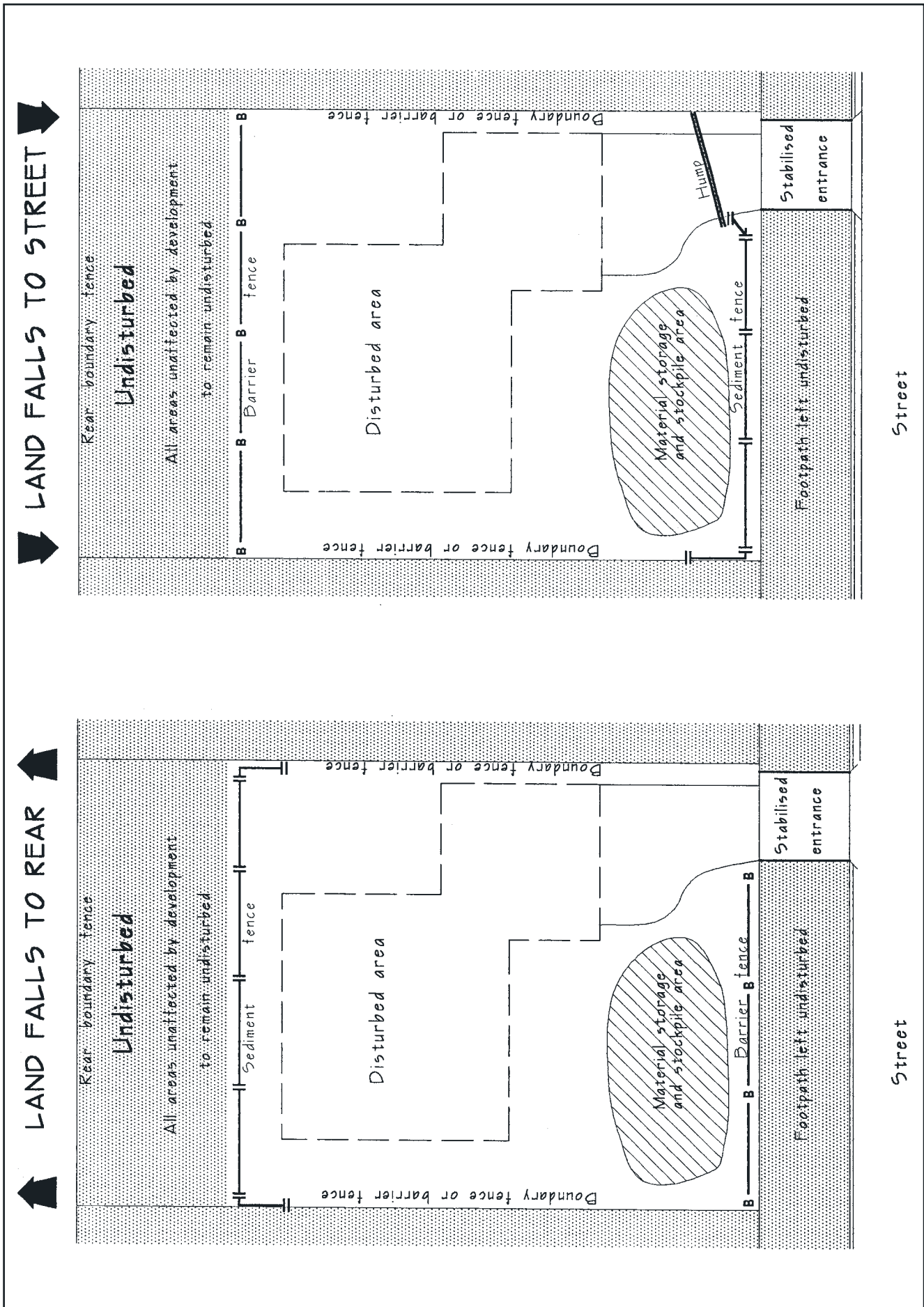


Figure 9.2 Two options for an ESCP where the site flows from the front and to the rear of the site

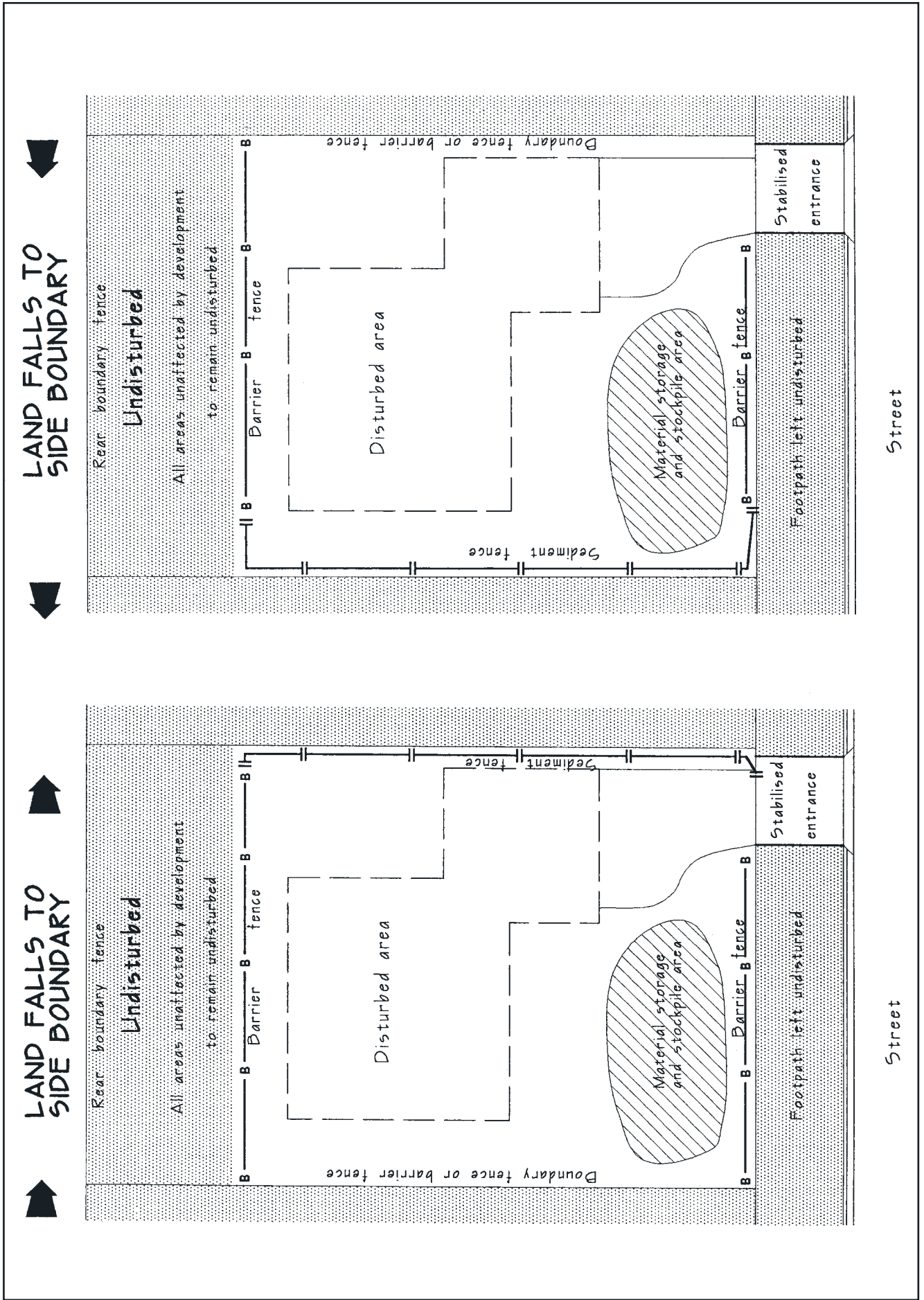


Figure 9.3 Two options for an ESCP where the site flows to either side of the site

or other suitable technique approved by the Council.

3. Sediment (SD 6-8) and barrier fences will be installed as shown on the attached drawing.
4. Mesh and gravel "sausage" protection (SD 6-11) will be provided to protect gutter inlets near the allotment.
5. Topsoil will be stripped and stockpiled (SD 4-1) for later use in landscaping the site.
6. All stockpiles will be placed in the location shown on the *ESCP* and at least 2 metres clear of all areas of possible areas of concentrated water flow, including driveways.
7. Lands to the rear and sides of the allotment and on the footpath will not be disturbed during works except where essential, e.g. drainage works across the footpath. Where works are necessary, they will be undertaken in such a way to leave the lands in a condition of high erosion hazards for as short a period as practicable. They will be rehabilitated as soon as possible. Stockpiles will not be placed on these lands and they will not be used as vehicle parking areas.
8. Approved bins for building waste, concrete and mortar slurries, paints, acid washings and litter will be provided and arrangements made for regular collection and disposal.
9. Guttering will be connected to the stormwater system (or rainwater tank, if present) as soon as practicable. If a rainwater tank is installed, the tank overflow should be connected to the stormwater system as soon as practicable.
10. Topsoil will be respread and all disturbed areas will be rehabilitated within 20 working days of the completion of works.
11. All erosion and sediment controls will be checked at least weekly and after rain to ensure they are maintained in a fully functional condition.
12. Photocopies of the following Standard Drawings are appended to this commentary:
 - SD 4-1 Stockpile Management
 - SD 5-5 Earth Bank, Low Flow
 - SD 6-8 Sediment Fence
 - SD 6-11 Mesh and Gravel Inlet
 - SD 6-14 Stabilised Site Access.
13. A drawing of the site showing the erosion and sediment control works is attached to this commentary (figure 9.4):

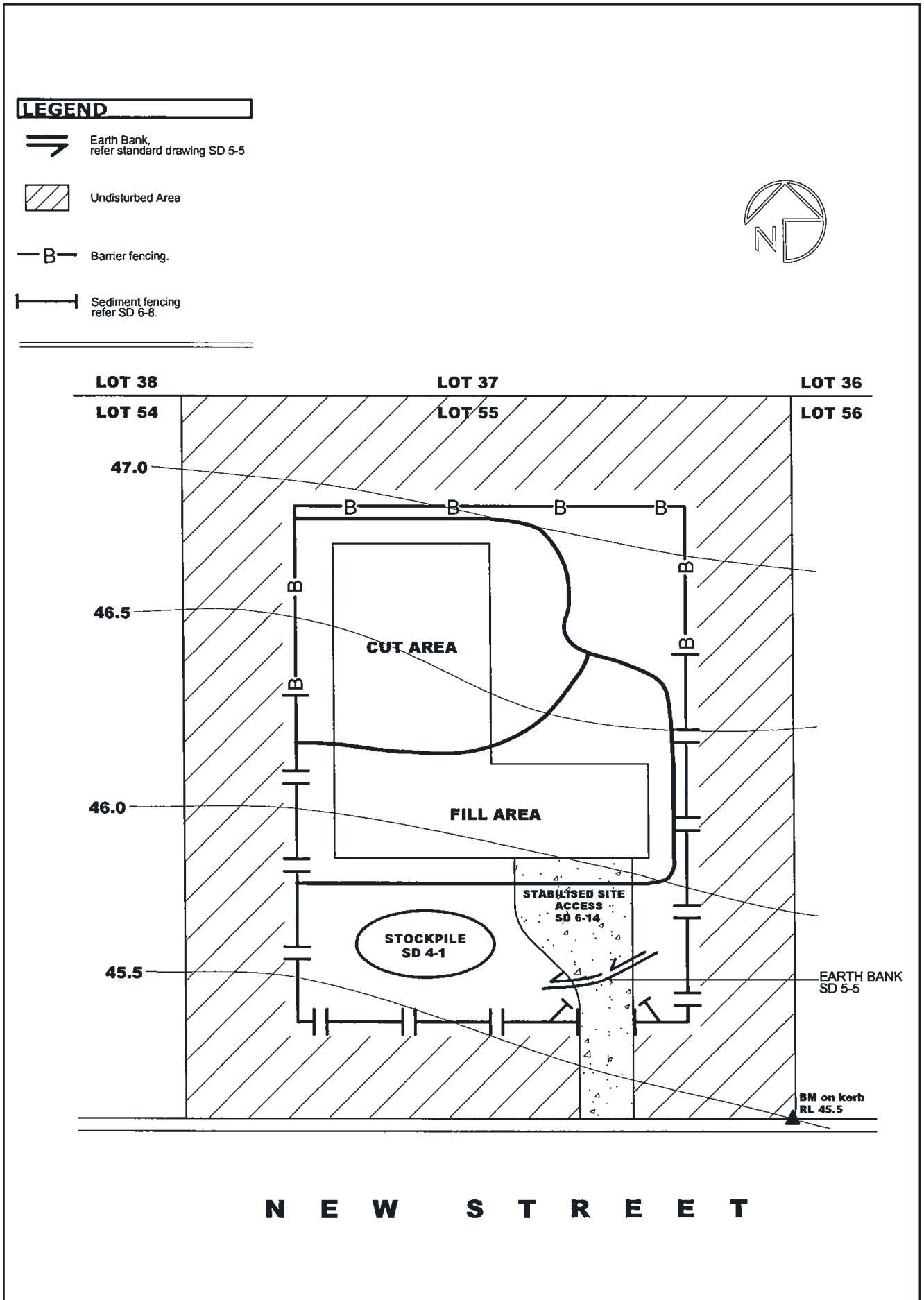


Figure 9.4 Erosion and sediment control plan for a residential dwelling

9.3 Medium-density Development Requiring a SWMP

9.3.1 Introduction

- (a) Plans showing how erosion and sediment will be controlled on larger (>2,500 square metres disturbed) sites require a *SWMP* as outlined in Chapter 2.
- (b) All *SWMPs* should include the relevant calculations of capacities for any sediment basins and other structures. These calculations should be:
 - based on an assessment of site-specific data
 - account for the pollution potential of the site
 - consider the sensitivity of receiving waters and other ESD matters.
- (c) The example here has been prepared for a site with landscape, soil and rainfall characteristics typical of suburban Sydney. It:
 - deals with the construction of eight town houses on 4,500 square metres
 - involves disturbing about 3,000 square metres of land
 - is based on data that is readily available from government and local government agencies throughout Sydney.
- (d) The model *SWMP* below was chosen because the site falls above the A-line in figure 4.6 and shows the complexity expected where the erosion hazard is high. Had slope gradients not exceeded 6 percent, the site would have fallen below the A-line and much of the detail that follows would not be required, including some relating to or derived from the *RUSLE* (Section 4.4.2).

9.3.2 Model *SWMP* for a Medium-density Development

Background

1. Site constraints and characteristics criteria are identified in Table 9.1.
2. The likely soil loss is calculated with the Revised Universal Soil Loss Equation (*RUSLE*). The values of the other *RUSLE* factors are: LS range of 0.31 to 1.75 (assuming a slope length of 40 m and a gradient range of 2 to 10%), P of 1.3, and the C is assumed to be 1.0 for bare soil. The site is on the Gynea Soil Landscape with Gy1, Gy2 and Gy3 soil materials (Chapman and Murphy, 1989) being identified through a preliminary investigation.
3. The design capacity for possible sediment basins for the total site is 85 cubic metres (Attachment). However, the estimated annual average soil loss is calculated to be 78 cubic metres using the *RUSLE*, which is less than 150 cubic metres; so a sediment basin is not required at this site.
4. Given that the site is Soil Loss Class 3 and these are not waterfront lands, no constraints on the timing of development occur at this site.

9. Urban Construction Sites

Table 9.1 Constraints and characteristics

Constraint/opportunity	Value
Rainfall erosivity	moderate (R-factor = 3,690)
Slope gradients	moderate (up to 10%)
Potential erosion hazard	high (from figure 4.6 in Landcom (2004))
Rainfall Zone	Zone 1
Soil erodibility	low to moderate (highest K-factor = 0.026)
Calculated soil loss	260 tonnes/ha/yr
Soil Loss Class	Class 3
Soil texture group	Type C (11 to 30% <0.02 mm)
Percent dispersible (subsoil)	insignificant (0 to 2% dispersible, Emerson Classes 6, 7 and 8)
Runoff coefficient	0.5 adopted
Disturbed site area	3,000 m ²

General Instructions

5. The SWMP (Drawing 922969) will be read with the engineering plans and any other plans or written instructions that may be issued and relating to development at the subject site.
6. Contractors will ensure that all soil and water management works are undertaken as instructed in this specification and constructed following the guidelines stated in *Managing Urban Stormwater: Soils & Construction* (Landcom 2004).
7. All subcontractors will be informed of their responsibilities in reducing the potential for soil erosion and pollution to downslope areas.

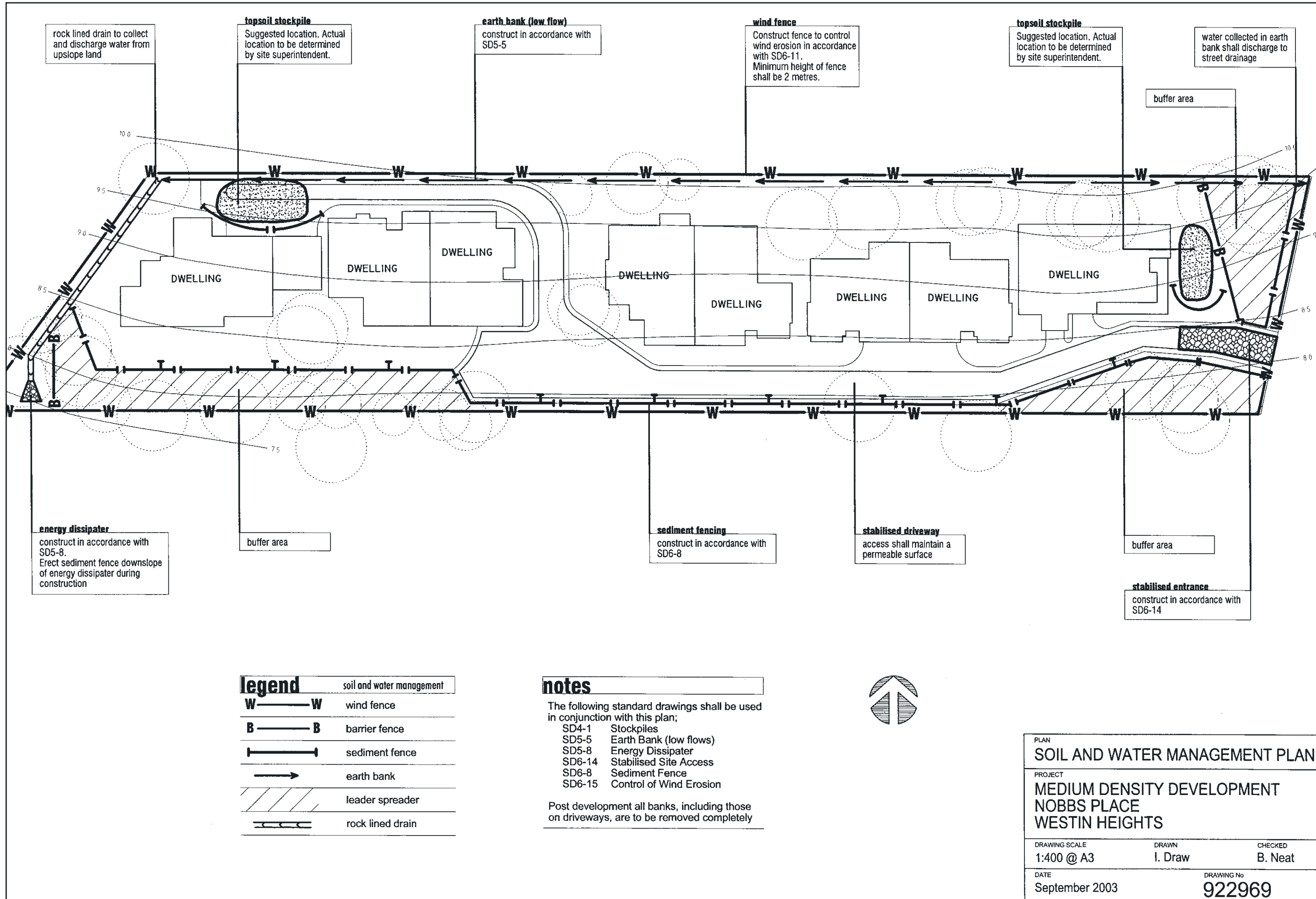
Land Disturbance Conditions

8. Where practicable, the soil erosion hazard on the site will be kept as low as possible and as recommended in Table 9.2.
9. Works will be undertaken in the following sequence:
 - (i) Install all barrier and sediment fencing where shown on Drawing 922969 to detail on Standard Drawing (SD) 6-8;
 - (ii) Construct the stabilised site access next to the eastern boundary to detail shown on SD 6-14;
 - (iii) Construct the rock lined drain on the western boundary;

Table 9.2 Limitations to access

Land use	Limitation	Comments
Construction areas	Disturbance to be no further than five (preferably two) metres from the edge of any essential engineering activity as shown on the plans	All site workers will clearly recognise these zones that, where appropriate, are identified with barrier fencing (upslope) and sediment fencing (downslope), or similar materials
Access areas	Limited to a maximum width of 10 metres	The site manager will determine and mark the location of these zones onsite. They can vary in position to best conserve the existing vegetation and protect downstream areas while being considerate of the needs of efficient works' activities. All site workers will clearly recognise their boundaries that, where appropriate, are marked with barrier mesh, sediment fencing, or similar materials
Remaining lands	Entry prohibited except for essential thinning of plant growth	Thinning of growth might be necessary for fire hazard reduction

- (iv) Construct low flow earth banks where shown on Drawing 922969 and to detail on SD 5-5;
- (v) Install wind break fencing (SD 6-15) where shown on the Drawing 922969;
- (vi) Install mesh and gravel filters (SD 6-11) at downslope kerb inlets;
- (vii) Install geotextile inlet filters (SD 6-12) around all drop inlets onsite;
- (viii) Clear the site and strip and stockpile the topsoil in the locations shown on Drawing 922969 following SD 4-1;
- (ix) Undertake all essential construction works ensuring that roof stormwater systems are connected to permanent drainage as soon as practical;
- (x) Grade lot areas to final grades and apply permanent stabilisation (landscaping) within 20 days of completion of construction works; and



rock lined drain to collect and discharge water from upslope land

topsoil stockpile
Suggested location. Actual location to be determined by site superintendent.

earth bank (low flow)
construct in accordance with SD5-5

wind fence
Construct fence to control wind erosion in accordance with SD6-11. Minimum height of fence shall be 2 metres.

topsoil stockpile
Suggested location. Actual location to be determined by site superintendent.

water collected in earth bank shall discharge to street drainage

buffer area

DWELLING

DWELLING

DWELLING

DWELLING

DWELLING

DWELLING

DWELLING

DWELLING

energy dissipater
construct in accordance with SD5-8. Erect sediment fence downslope of energy dissipater during construction

buffer area

sediment fencing
construct in accordance with SD6-8

stabilised driveway
access shall maintain a permeable surface

buffer area

stabilised entrance
construct in accordance with SD6-14

legend		soil and water management	
W	—	W	wind fence
B	—	B	barrier fence
—	—	—	sediment fence
—	→		earth bank
—	—	—	leader spreader
—	—	—	rock lined drain

notes

The following standard drawings shall be used in conjunction with this plan;

- SD4-1 Stockpiles
- SD5-5 Earth Bank (low flows)
- SD5-8 Energy Dissipater
- SD6-14 Stabilised Site Access
- SD6-8 Sediment Fence
- SD6-15 Control of Wind Erosion

Post development all banks, including those on driveways, are to be removed completely



PLAN		
SOIL AND WATER MANAGEMENT PLAN		
PROJECT		
MEDIUM DENSITY DEVELOPMENT NOBBS PLACE WESTIN HEIGHTS		
DRAWING SCALE	DRAWN	CHECKED
1:400 @ A3	I. Draw	B. Neat
DATE	DRAWING No	
September 2003	922969	

9. Urban Construction Sites

- (xi) Remove temporary erosion control measures after the permanent landscaping has been completed.

Soil Erosion Control Conditions

10. Clearly visible barrier fencing will be installed where shown on Drawing 922969 and elsewhere at the discretion of the site superintendent to ensure traffic control and prohibit unnecessary site disturbance.
11. Earth batters will be constructed with as low a gradient as practicable but no steeper than:
 - 2(H):1(V) where slope length is less than 13 metres
 - 2.5(H):1(V) where slope length is between 13 and 17 metres
 - 3(H):1(V) where slope length is between 17 and 20 metres
 - 4(H):1(V) where slope length is greater than 20 metres.
12. All waterways, drains spillways and their outlets will be constructed to be stable in at least the 10 year ARI, time of concentration storm event.
13. Protection from erosive forces will be undertaken on all lands to meet the requirements of Table 9.3.
14. A suggested listing of plant species for temporary cover in areas of sheet flow is shown in Table 9.4. Reinforced Kikuyu turf is suggested for use in waterways. Wherever practicable, foot and vehicular traffic will be kept away from rehabilitated areas.
15. Permanent rehabilitation will achieve a C-factor of less than 0.1 and set in motion a program that should ensure it will drop permanently, by vegetation, paving, armouring, etc. to less than 0.05 within a further 60 days. Local water restrictions permitting, lands that have been newly planted with grass species will be watered regularly until an effective cover has established and plants are growing vigorously. Follow-up seed and fertiliser will be applied as necessary in areas of minor soil erosion and/or inadequate vegetative protection.
16. The revegetation will be aimed at reestablishing natural species. Therefore, the natural surface soils will be replaced and non persistent annual cover crops will be used.

Sediment Control Conditions

17. Sediment fences (SD 6-8) will:
 - (i) be installed where shown on Drawing 922969 and elsewhere at the discretion of the site superintendent to contain the coarser sediment fractions (including aggregated fines) as near as possible to their source; and

Table 9.3 Maximum C-factors at Nominated Times During Works

Lands	Maximum Cfactor	Remarks
Waterways and other areas subjected to concentrated flows, post construction	0.05	Applies after ten working days from completion of formation and before they are allowed to carry any concentrated flows. Flows will be limited to those shown in Table 5.1 of Managing Urban Stormwater – Soils & Construction, Landcom (2004). Foot and vehicular traffic will be prohibited in these areas (70% ground cover)
Stockpiles, post-construction	0.1	Applies after ten working days from completion of formation. Maximum C-factor of 0.10 equals 60% ground cover
All lands, including waterways and stockpiles during construction	0.15	Applies after 20 working days of inactivity, even though works might continue later. Maximum C-factor of 0.15 equals 50% ground cover

Table 9.4 Plant Species for Ground Cover

Sowing season	Seed mix
Autumn / Winter	oats @ 40 kg/ha Japanese millet @ 10 kg/ha
Spring / Summer	Japanese millet @ 20 kg/ha oats @ 20 kg/ha

9. Urban Construction Sites

- (ii) have catchment areas not exceeding 900 square metres, a storage depth (including both settling and settled zones) of at least 0.6 metres, and internal dimensions that provide maximum surface area to passage of stormwater (i.e. very low gradient).
- 18. Sediment removed from any trapping device will be relocated where further pollution to downslope lands and waterways cannot occur.
- 19. Stockpiles (SD 4-1) will be placed where shown on Drawing 922969 and not within 5 metres of hazard areas including likely areas of high velocity flows such as waterways, paved areas and driveways.
- 20. Water will be prevented from directly entering the permanent drainage system with inlet filters (SD 6-11 or SD 6-12) unless it is relatively sediment free, i.e. the catchment area has been permanently landscaped and/or any likely sediment has been treated in an approved device. The actual locations of the inlet filters will be chosen by the Site Superintendent to protect the receiving waters best and, therefore, are not shown on Drawing 922969.
- 21. Temporary sediment traps will be retained until after the lands they are protecting, are completely rehabilitated.

Other Matters

- 22. Acceptable bins will be provided for any concrete and mortar slurries, paints, acid washing, lightweight waste materials and litter. Clearance services will be provided weekly.

Site Inspection and Maintenance Conditions

- 23. Waste bins will be emptied as necessary. Disposal of waste will be in a manner approved by the site superintendent.
- 24. The site superintendent will inspect the site at least weekly and will:
 - (i) ensure that drains operate properly and to effect any necessary repairs;
 - (ii) remove spilled sand or other materials from hazard areas, including lands closer than five metres from areas of likely concentrated or high velocity flows especially waterways and paved areas;
 - (iii) remove trapped sediment whenever less than design capacity remains within the structure;
 - (iv) ensure rehabilitated lands have effectively reduced the erosion hazard and to initiate upgrading or repair as appropriate;
 - (v) construct additional erosion and/or sediment control works as might become necessary to ensure the desired protection is given to downslope lands and

waterways, i.e. make ongoing changes to Drawing 922969 where it proves inadequate in practice or is subjected to changes in conditions on the work-site or elsewhere in the catchment;

- (vi) maintain erosion and sediment control measures in a fully functioning condition until all earthwork activities are completed and the site is rehabilitated; and
- (vii) remove temporary soil conservation structures as the last activity in the rehabilitation program.

25. As a part of the statutory "diligence and care" responsibilities, the site superintendent will keep a logbook, making entries at least weekly, immediately before forecast rain and after rainfall. Entries will include:

- (i) the volume and intensity of any rainfall events;
- (ii) the condition of any soil and water management works;
- (iii) the condition of vegetation and any need to irrigate;
- (iv) the need for dust prevention strategies; and
- (v) any remedial works to be undertaken.

The book will be kept on-site and made available to any authorised person on request. It will be given to the project manager at the conclusion of works.

Attachment: Sediment Basin Volume Calculation

Basin volume = settling zone volume + sediment storage volume

Settling Zone Volume

The settling zone volume for Type C Soils is calculated to provide capacity to allow the design particle (i.e. 0.02 mm) to settle in the peak flow expected from the design storm (i.e. the 3-month storm). The volume of the basin's settling zone (V) can be determined as a function of the basin's surface area and depth to allow for particles to settle.

Peak flow for the 3-month storm is given by the Rational Formula:

$$Q_{t_c, 0.25} = 0.5 \times (0.00278 \times C_{10} \times F_1 \times I_{1yr, t_c} \times A) \text{ m}^3/\text{sec}$$

where:

$Q_{t_c, 0.25}$ = flow rate (m³/sec) for half the one year storm event (Section 6.35(c))

0.5 = a conversion factor to derive half 1-year event

C_{10} = runoff coefficient (dimensionless) for ARI of 10 years (=0.8)

F_1 = frequency factor for 1 year (= 0.62)

I_{1yr, t_c} = average rainfall intensity (mm/hr) for the 1 year, storm event (= 92.2)

A = area of catchment in hectares (ha) (= 0.45)

$$Q_{t_c, 0.25} = 0.5 \times 0.00278 \times C_{10} \times F_1 \times I_{1yr, t_c} \times A \text{ (m}^3/\text{sec)}$$

$$\begin{aligned} Q_{t_c, 0.25} &= 0.5 \times 0.00278 \times 0.8 \times 0.62 \times 92.2 \times 0.45 \text{ (m}^3/\text{sec)} \\ &= 0.0286 \text{ m}^3/\text{sec} \end{aligned}$$

9. Urban Construction Sites

The basin surface area is dependent on the flow rate into the basin (0.0286 m³/sec) and the size of the design sediment particle, taken here as 0.02 mm.

$$\begin{aligned}\text{Basin surface area} &= 4,100 \times 0.0286 \\ &= 120 \text{ m}^2\end{aligned}$$

The basin settling volume can be calculated using a minimum depth of 0.6 metres.

$$\begin{aligned}\text{Settling zone volume} &= \text{basin surface area} \times \text{depth} \\ &= 120 \times 0.6 \\ &= 72 \text{ m}^3\end{aligned}$$

Sediment Storage Volume

The sediment storage zone is calculated as the largest of 100 percent of the capacity of the settling zone and two months soil loss as calculated by the RUSLE. The settling zone volume is 72 m³ while two months soil loss is:

$$\begin{aligned}\text{Sediment storage zone}_{\text{Type C}} &= 0.17 \times A (R \times K \times LS \times 1.3 \times 1.0) / 1.3 \\ &= 0.17 \times 0.45 (3,690 \times 0.026 \times 1.75 \times 1.3 \times 1.0) / 1.3 \\ &= 13 \text{ m}^3\end{aligned}$$

$$\begin{aligned}\text{Total basin volume} &= \text{settling zone volume} + \text{sediment storage volume} \\ &= 72 + 72 \\ &= 144 \text{ m}^3\end{aligned}$$

The calculated average annual soil loss of 78 m³ (13 x 6) is less than the limiting size of 150 m³. Therefore, on this site a sediment basin is not required. Successful containment and control of sediment is to be attained through the use of other on site treatment techniques.

Photocopies of the following Standard Drawings are appended to these notes:

- SD 4-1 Stockpiles
- SD 5-5 Earth bank (low flows)
- SD 5-8 Energy dissipater
- SD 6-4 Stabilised site access
- SD 6-8 Sediment fence
- SD 6-11 Mesh and gravel inlet filter
- SD 6-12 Geotextile inlet filter
- SD 6-15 Control of wind erosion.

9.4 Subdivision Development Requiring a SWMP

9.4.1 Model SWMP for a Subdivision Development

Introductory Notes

- (a) The model *SWMP* below is based on a development proposal in the Sydney area. Here, we have given the site the fictitious name of Sunshine Heights. It included the subdivision of building allotments, construction of road access and bridge works and installation of underground services. The total area affected by this development was 4 hectares with 2.1 hectares to be disturbed.
- (b) The original proposal for soil and water management included several post development water quality control systems, e.g. installing the wetland component of a water quality control pond (WQCP) and gross pollutant trap. However, these guidelines only address the control of soil erosion and sediment pollution during the construction and site rehabilitation phases and not to work post development. In line with this focus, the model *SWMP* included here only addresses the construction and rehabilitation phase works.
- (c) The model *SWMP* below was chosen because the site falls above the A-line in figure 4.6 and shows the complexity expected where the erosion hazard is high. Had slope gradients not exceeded 9 percent, the site would have fallen below the A-line and much of the detail that follows would not be required, including some relating to or derived from the RUSLE (Section 4.4.2).

Model Soil & Water Management Plan (*SWMP*)

1. This is a conceptual *SWMP* only. It provides sufficient detail to show clearly that the works can proceed without undue pollution to receiving waters. A detailed Plan will be prepared once consent is given and before works start.
2. Important site constraints and characteristics criteria are identified in Table 9.5.
3. The values of RUSLE factors not listed in Table 9.5 are:
 - (i) LS-factor is 2.81, assuming slope length of 80 metres and typical upper slope gradients for works areas of 10 percent;
 - (ii) P-factor is 1.3; and
 - (iii) the C-factor is assumed to be 1.0 for bare soil.

The site is on the Lambert Soil Landscape (Chapman and Murphy, 1989) with la1, la2 and la3 soil materials being identified through a preliminary soil survey. While la6 was not found in the soil survey, investigations were not detailed enough to preclude its existence and it is assumed to be present throughout.
4. The settling zone volume of the sediment basin will be calculated using the containment of the 5-day, 75th percentile rainfall event.
5. A volumetric runoff coefficient of 0.5 is adopted, in this instance, a conservative value.

9. Urban Construction Sites

Table 9.5 Constraints and characteristics

Constraint/characteristic	Value/rating
Rainfall erosivity	moderate (R-factor is 2,500)
Slope gradient	moderate (up to 10 percent)
Potential erosion hazard	high (from figure 4.6 in Landcom (2004))
Rainfall Zone	Zone 1
Soil erodibility (subsoil)	low to moderate (0.016 to 0.036)
Calculated soil loss	up to 330 t/ha/yr
Soil Loss Class	Class 3
Soil texture group	Type D
Percent dispersible (subsoil)	3 to 12 percent
Runoff coefficient	0.5 adopted
Total site area	4.0 ha
Disturbed site area	2.1 ha
75th %ile, 5-day rainfall event	Sunshine Heights = 18.6mm

General Instruction Conditions

6. The *SWMP* will be read with the engineering plans and any other plans or written instructions issued in relation to development at the subject site.
7. Contractors will ensure that all soil and water management works are undertaken as instructed in this specification and following the guidelines outlined in *Managing Urban Stormwater: Soils & Construction* (Landcom, 2004).
8. All subcontractors will be informed of their responsibilities in minimising the potential for soil erosion and pollution to downslope areas.

Land Disturbance

9. Where practicable, the soil erosion hazard on the site will be kept as low as possible and as recommended in Table 9.6.

Work Schedule Conditions

10. Works will be undertaken in the following sequence. Each subsequent stage is not to commence until the previous one is completed.

Table 9.6 Limitations to access

Land use	Limitation	Comments
Construction areas	Disturbance to be no further than five (preferably two) metres from the edge of any essential engineering activity as shown on the plans	All site workers will clearly recognise these zones that, where appropriate, are identified with barrier fencing (upslope) and sediment fencing (downslope), or similar materials
Access areas	Limited to a maximum width of 10 metres	The site manager will determine and mark the location of these zones onsite. They can vary in position to best conserve the existing vegetation and protect downstream areas while being considerate of the needs of efficient works' activities. All site workers will clearly recognise their boundaries that, where appropriate, are marked with barrier mesh, sediment fencing, or similar materials
Remaining lands	Entry prohibited except for essential thinning of plant growth	Thinning of growth might be necessary for fire hazard reduction
Work on waterfront lands	Generally, restricted to the period 1 June to 15 November	Where work is to occur outside the period 1 June to 15 November, C-factors will be above 0.1 only when the 3-day forecast suggests that rain is unlikely. Further, sufficient 350 gsm jute matting (or equivalent) will be available to reduce the C-factor to less than 0.1 should the forecast prove incorrect or rapid rehabilitation is required for any other reason

9. Urban Construction Sites

Stage 1 Conditions (refer to Drawings 922970-1 and 922970-2)

11. Construct stabilised site accesses (SD 6-14).
12. Install all barrier fencing to exclude access to the nominated restricted areas.
13. Construct Earth Banks 1, 2, 10, 11, and 12 (SD 5-6) to direct overland flow to lands beyond the site.
14. Provide temporary access to the four sediment basins on the alignment of the permanent roadways and protect this with sediment fencing (SD 6-8) or barrier fencing and Earth Bank 3 (SD 5-5). Note that it is not intended to start the road works set down for Stage 2 here.
15. Place sediment fences (SD 6-7) downslope of lands to be disturbed for construction of the sediment basins.
16. Construct Sediment basins 1, 2, 3, and 4 (SD 6-4). These basins do not need to be constructed in earth as shown in SD 6-4 but they must be constructed in impervious materials.
17. Construct Energy Dissipaters 1, 2, 3 and 4 (SD 5-8) at the outlet of each sediment basin.
18. Stabilise land surfaces disturbed by construction of the four sediment basins as soon as final levels are established.
19. Construct Earth Banks 4, 5, 6, 7, 8 and 9 (SD 5-6) to direct overland flow to the sediment basins.
20. Install Stormwater Pipes 1 and 2 and Energy Dissipaters 5 and 6. The passage of Stormwater Pipe 1 under the road and down the southern boundary of Lot 22 is temporary – it will join the road drainage in Stage 4 (pipe design parameters not included here).

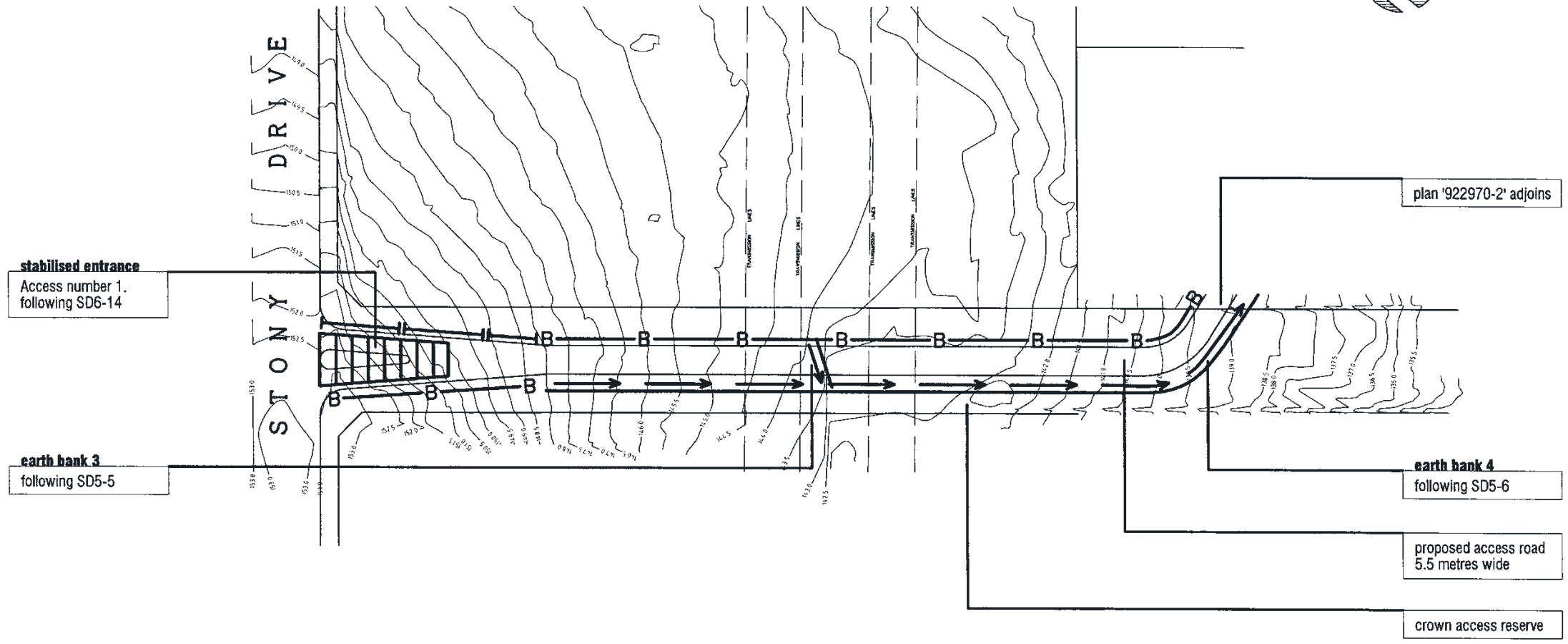
Stage 2 Conditions (refer to Drawings 922970-1 and 922970-2).

21. Strip and stockpile topsoil (SD 4-1) from those lands to be exposed to construction activities.
22. Undertake road and drainage works according to the engineering plans – but see Condition 25, below and note the need to connect Earth Banks 5 to 8 and 6 to 7 in Stage 4 temporarily.
23. Once the access road shown upslope of Sediment Basin 1 has been constructed and the site stabilised, Stabilised Access 1 and Earth Banks 3 and 4 can be removed.
24. Once the road system east of the creek line has been completed and surrounding lands stabilised, Stabilised Access 2 can be removed.

-
25. Ensure all allotment and roadway stormwater drains to a sediment retention basin.
 26. Where practical to do so, complete road and drainage works within the restricted area next to the creek (assumed to be waterfront lands) totally within the period 1 June to 15 November (see Condition 27, below where this is not practical). This includes installation of a WQCP, gross pollutant trap (GPT) and associated roadworks (separate plans are available for completion of the WQCP and installation of the CDS device). Do not complete roadworks to the eastern abutment of the southern bridge until Stage 4. Ensure the road works do not hinder the flow in Earth Banks 7 and 8 – possibly requiring the construction of temporary culverts.
 27. Where completing the requirements of Condition 26, above, is not practical, ensure all lands within the restricted area next to the creek, have C-factors above 0.1 only when the 3-day forecast suggests that rain is unlikely. Ensure provision of sufficient 350 gsm jute matting or equivalent (SD 5-2 and SD 5-7), to reduce the C-factor to less than 0.1 on all disturbed lands should the forecast prove incorrect or rapid rehabilitation is required for another reason.

Stage 3 Conditions (refer to Drawings 922970-3 and 922970-4)

28. Conditions 26 and 27 for Stage 2, above, apply to the whole of Stage 3.
29. Remove all sediment from Sediment Basins 3 and 4. Decommission Sediment Basins 3 and 4 and the associated energy dissipaters.
30. Construct the creek diversion around the eastern side of the proposed WQCP.
31. Construct Phase 1 of the WQCP (details are provided in a separate set of plans). Note that the wetland component of this structure is to operate as Sediment Basins 5 and 6 until Stage 6 and replace Sediment Basins 1, 2, 3 and 4. This requires:
 - (i) modified inlets to ensure that polluted waters enter the sediment basins directly and not the WQCP sediment fore-bay;
 - (ii) temporary spillway outlets to the open water zone; and
 - (iii) extra depth to the structures to achieve capacities in:
 - Sediment Basin 5 greater than the combined design capacities of Sediment Basins 1 and 3
 - Sediment Basin 6 greater than the combined design capacities of Sediment Basins 2 and 4.
32. Upon completion of Sediment Basin 5 and stabilisation of disturbed lands, divert waters into it that had previously entered Sediment Basin 3.
33. After Sediment Basin 5 has been commissioned, remove the creek diversion around the eastern side of the WQCP.

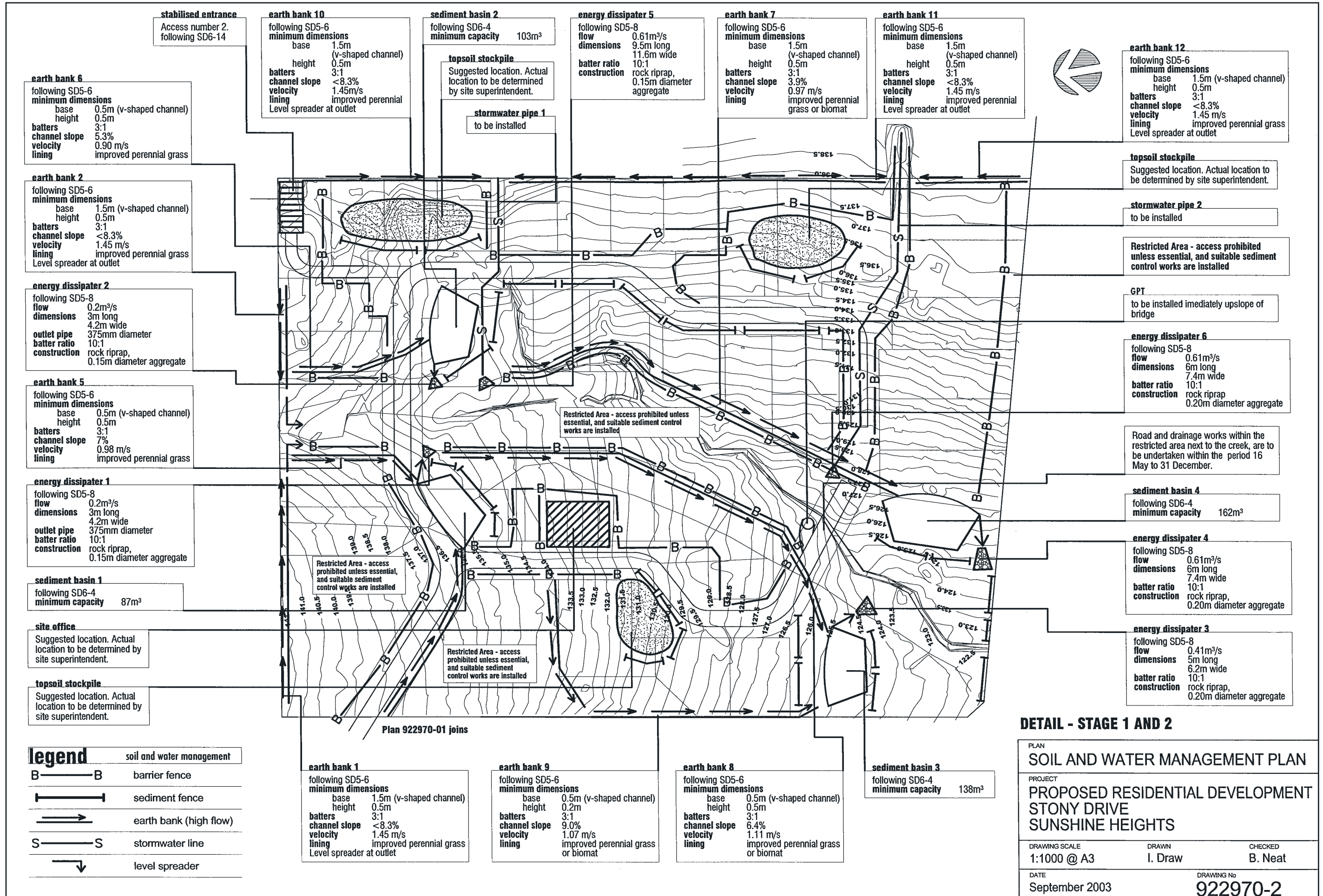


legend soil and water management

- B — B barrier fence
- |— sediment fence
- ⇒⇒⇒ earth bank (high flow)
- ⇒⇒⇒ earth bank (low flow)

DETAIL - STAGE 1 AND 2

PLAN		
SOIL AND WATER MANAGEMENT PLAN		
PROJECT		
PROPOSED ACCESS ROAD STONY DRIVE SUNSHINE HEIGHTS		
DRAWING SCALE	DRAWN	CHECKED
1:1000 @ A3	I. Draw	B. Neat
DATE	DRAWING No	
September 2003	922970-1	



stabilised entrance
Access number 2.
following SD6-14

earth bank 10
following SD5-6
minimum dimensions
base 1.5m
height 0.5m (v-shaped channel)
batters 3:1
channel slope <8.3%
velocity 1.45m/s
lining improved perennial
Level spreader at outlet

sediment basin 2
following SD6-4
minimum capacity 103m³

topsoil stockpile
Suggested location. Actual location to be determined by site superintendent.

energy dissipater 5
following SD5-8
flow 0.61m³/s
dimensions 9.5m long
11.6m wide
batter ratio 10:1
construction rock riprap,
0.15m diameter aggregate

earth bank 7
following SD5-6
minimum dimensions
base 1.5m
height 0.5m (v-shaped channel)
batters 3:1
channel slope 3.9%
velocity 0.97 m/s
lining improved perennial grass or biomat

earth bank 11
following SD5-6
minimum dimensions
base 1.5m
height 0.5m (v-shaped channel)
batters 3:1
channel slope <8.3%
velocity 1.45 m/s
lining improved perennial
Level spreader at outlet



earth bank 12
following SD5-6
minimum dimensions
base 1.5m (v-shaped channel)
height 0.5m
batters 3:1
channel slope <8.3%
velocity 1.45 m/s
lining improved perennial grass
Level spreader at outlet

earth bank 6
following SD5-6
minimum dimensions
base 0.5m (v-shaped channel)
height 0.5m
batters 3:1
channel slope 5.3%
velocity 0.90 m/s
lining improved perennial grass

earth bank 2
following SD5-6
minimum dimensions
base 1.5m (v-shaped channel)
height 0.5m
batters 3:1
channel slope <8.3%
velocity 1.45 m/s
lining improved perennial grass
Level spreader at outlet

energy dissipater 2
following SD5-8
flow 0.2m³/s
dimensions 3m long
4.2m wide
outlet pipe 375mm diameter
batter ratio 10:1
construction rock riprap,
0.15m diameter aggregate

earth bank 5
following SD5-6
minimum dimensions
base 0.5m (v-shaped channel)
height 0.5m
batters 3:1
channel slope 7%
velocity 0.98 m/s
lining improved perennial grass

energy dissipater 1
following SD5-8
flow 0.2m³/s
dimensions 3m long
4.2m wide
outlet pipe 375mm diameter
batter ratio 10:1
construction rock riprap,
0.15m diameter aggregate

sediment basin 1
following SD6-4
minimum capacity 87m³

site office
Suggested location. Actual location to be determined by site superintendent.

topsoil stockpile
Suggested location. Actual location to be determined by site superintendent.

stormwater pipe 1
to be installed

topsoil stockpile
Suggested location. Actual location to be determined by site superintendent.

stormwater pipe 2
to be installed

Restricted Area - access prohibited unless essential, and suitable sediment control works are installed

GPT
to be installed immediately upslope of bridge

energy dissipater 6
following SD5-8
flow 0.61m³/s
dimensions 6m long
7.4m wide
batter ratio 10:1
construction rock riprap
0.20m diameter aggregate

Road and drainage works within the restricted area next to the creek, are to be undertaken within the period 16 May to 31 December.

sediment basin 4
following SD6-4
minimum capacity 162m³

energy dissipater 4
following SD5-8
flow 0.61m³/s
dimensions 6m long
7.4m wide
batter ratio 10:1
construction rock riprap,
0.20m diameter aggregate

energy dissipater 3
following SD5-8
flow 0.41m³/s
dimensions 5m long
6.2m wide
batter ratio 10:1
construction rock riprap,
0.20m diameter aggregate

earth bank 1
following SD5-6
minimum dimensions
base 1.5m (v-shaped channel)
height 0.5m
batters 3:1
channel slope <8.3%
velocity 1.45 m/s
lining improved perennial grass
Level spreader at outlet

earth bank 9
following SD5-6
minimum dimensions
base 0.5m (v-shaped channel)
height 0.2m
batters 3:1
channel slope 9.0%
velocity 1.07 m/s
lining improved perennial grass or biomat

earth bank 8
following SD5-6
minimum dimensions
base 0.5m (v-shaped channel)
height 0.5m
batters 3:1
channel slope 6.4%
velocity 1.11 m/s
lining improved perennial grass or biomat

sediment basin 3
following SD6-4
minimum capacity 138m³

- Legend** soil and water management
- B — B barrier fence
 - — — sediment fence
 - — — earth bank (high flow)
 - S — S stormwater line
 - — — level spreader

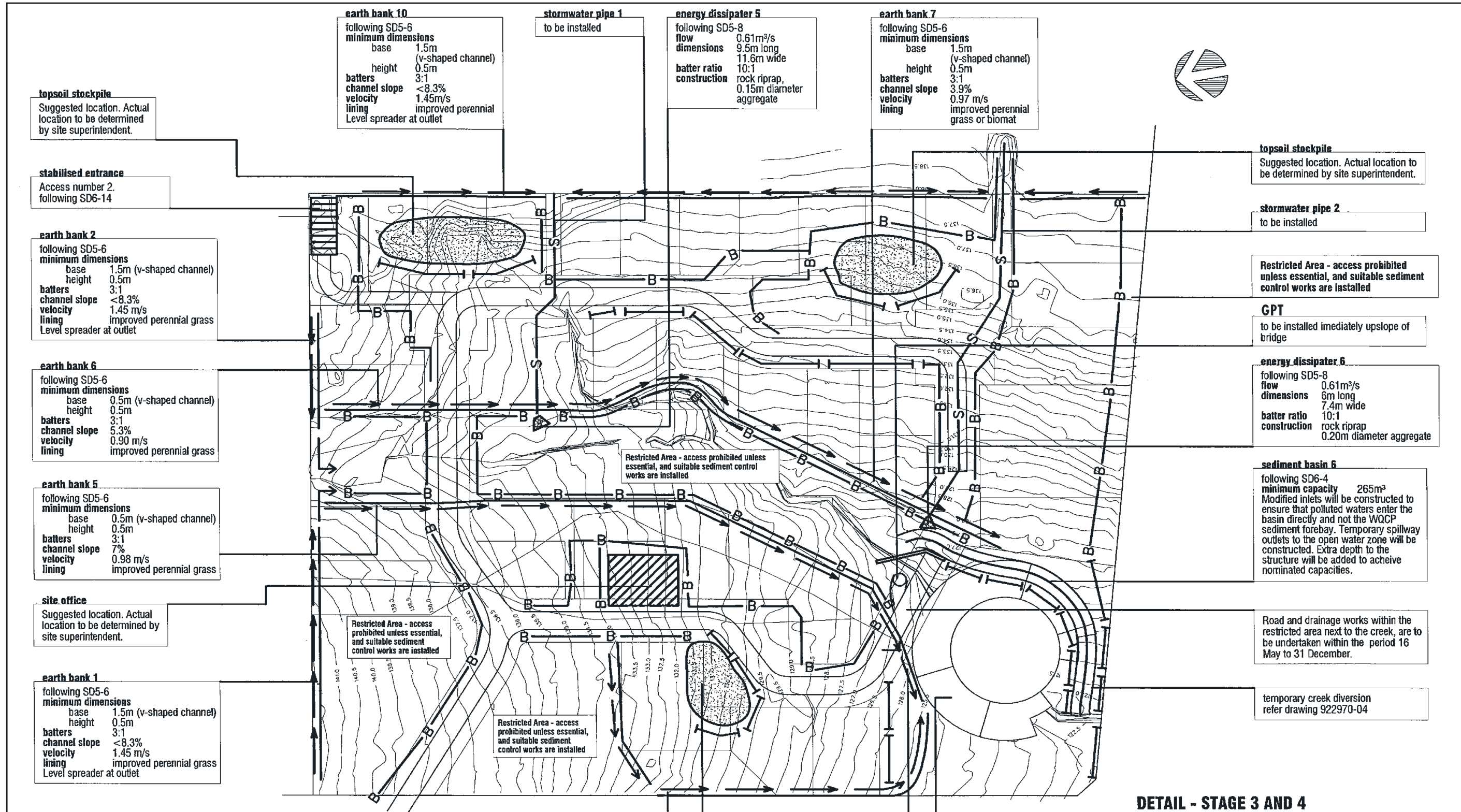
DETAIL - STAGE 1 AND 2

PLAN
SOIL AND WATER MANAGEMENT PLAN

PROJECT
**PROPOSED RESIDENTIAL DEVELOPMENT
STONY DRIVE
SUNSHINE HEIGHTS**

DRAWING SCALE 1:1000 @ A3 DRAWN I. Draw CHECKED B. Neat

DATE September 2003 DRAWING No 922970-2



topsoil stockpile
Suggested location. Actual location to be determined by site superintendent.

stabilised entrance
Access number 2.
following SD6-14

earth bank 2
following SD5-6
minimum dimensions
base 1.5m (v-shaped channel)
height 0.5m
batters 3:1
channel slope <8.3%
velocity 1.45 m/s
lining improved perennial grass
Level spreader at outlet

earth bank 6
following SD5-6
minimum dimensions
base 0.5m (v-shaped channel)
height 0.5m
batters 3:1
channel slope 5.3%
velocity 0.90 m/s
lining improved perennial grass

earth bank 5
following SD5-6
minimum dimensions
base 0.5m (v-shaped channel)
height 0.5m
batters 3:1
channel slope 7%
velocity 0.98 m/s
lining improved perennial grass

site office
Suggested location. Actual location to be determined by site superintendent.

earth bank 1
following SD5-6
minimum dimensions
base 1.5m (v-shaped channel)
height 0.5m
batters 3:1
channel slope <8.3%
velocity 1.45 m/s
lining improved perennial grass
Level spreader at outlet

earth bank 10
following SD5-6
minimum dimensions
base 1.5m (v-shaped channel)
height 0.5m
batters 3:1
channel slope <8.3%
velocity 1.45m/s
lining improved perennial
Level spreader at outlet

stormwater pipe 1
to be installed

energy dissipater 5
following SD5-8
flow 0.61m³/s
dimensions 9.5m long
11.6m wide
batter ratio 10:1
construction rock riprap,
0.15m diameter aggregate

earth bank 7
following SD5-6
minimum dimensions
base 1.5m (v-shaped channel)
height 0.5m
batters 3:1
channel slope 3.9%
velocity 0.97 m/s
lining improved perennial grass or biomat

topsoil stockpile
Suggested location. Actual location to be determined by site superintendent.

stormwater pipe 2
to be installed

Restricted Area - access prohibited unless essential, and suitable sediment control works are installed

GPT
to be installed immediately upslope of bridge

energy dissipater 6
following SD5-8
flow 0.61m³/s
dimensions 6m long
7.4m wide
batter ratio 10:1
construction rock riprap
0.20m diameter aggregate

sediment basin 6
following SD6-4
minimum capacity 265m³
Modified inlets will be constructed to ensure that polluted waters enter the basin directly and not the WQCP sediment forebay. Temporary spillway outlets to the open water zone will be constructed. Extra depth to the structure will be added to achieve nominated capacities.

Road and drainage works within the restricted area next to the creek, are to be undertaken within the period 16 May to 31 December.

temporary creek diversion refer drawing 922970-04

Restricted Area - access prohibited unless essential, and suitable sediment control works are installed

Restricted Area - access prohibited unless essential, and suitable sediment control works are installed

Restricted Area - access prohibited unless essential, and suitable sediment control works are installed

Legend soil and water management

B — B	barrier fence
— — —	sediment fence
—>>>	earth bank (high flow)
S — S	stormwater line
—>	level spreader

earth bank 9
following SD5-6
minimum dimensions
base 0.5m (v-shaped channel)
height 0.2m
batters 3:1
channel slope 9.0%
velocity 1.07 m/s
lining improved perennial grass or biomat

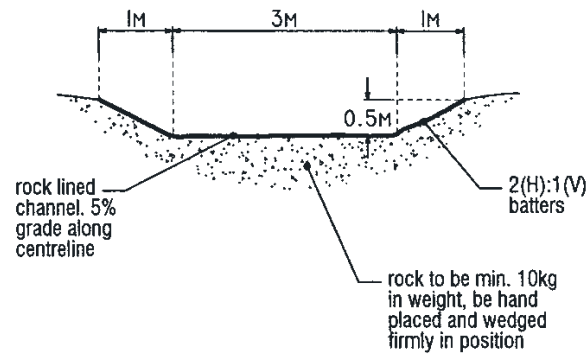
topsoil stockpile
Suggested location. Actual location to be determined by site superintendent.

earth bank 8
following SD5-6
minimum dimensions
base 0.5m (v-shaped channel)
height 0.5m
batters 3:1
channel slope 6.4%
velocity 1.11 m/s
lining improved perennial grass or biomat

sediment basin 5
following SD6-4
minimum capacity 225m³
Modified inlets will be constructed to ensure that polluted waters enter the basin directly and not the WQCP sediment forebay. Temporary spillway outlets to the open water zone will be constructed. Extra depth to the structure will be added to achieve nominated capacities.

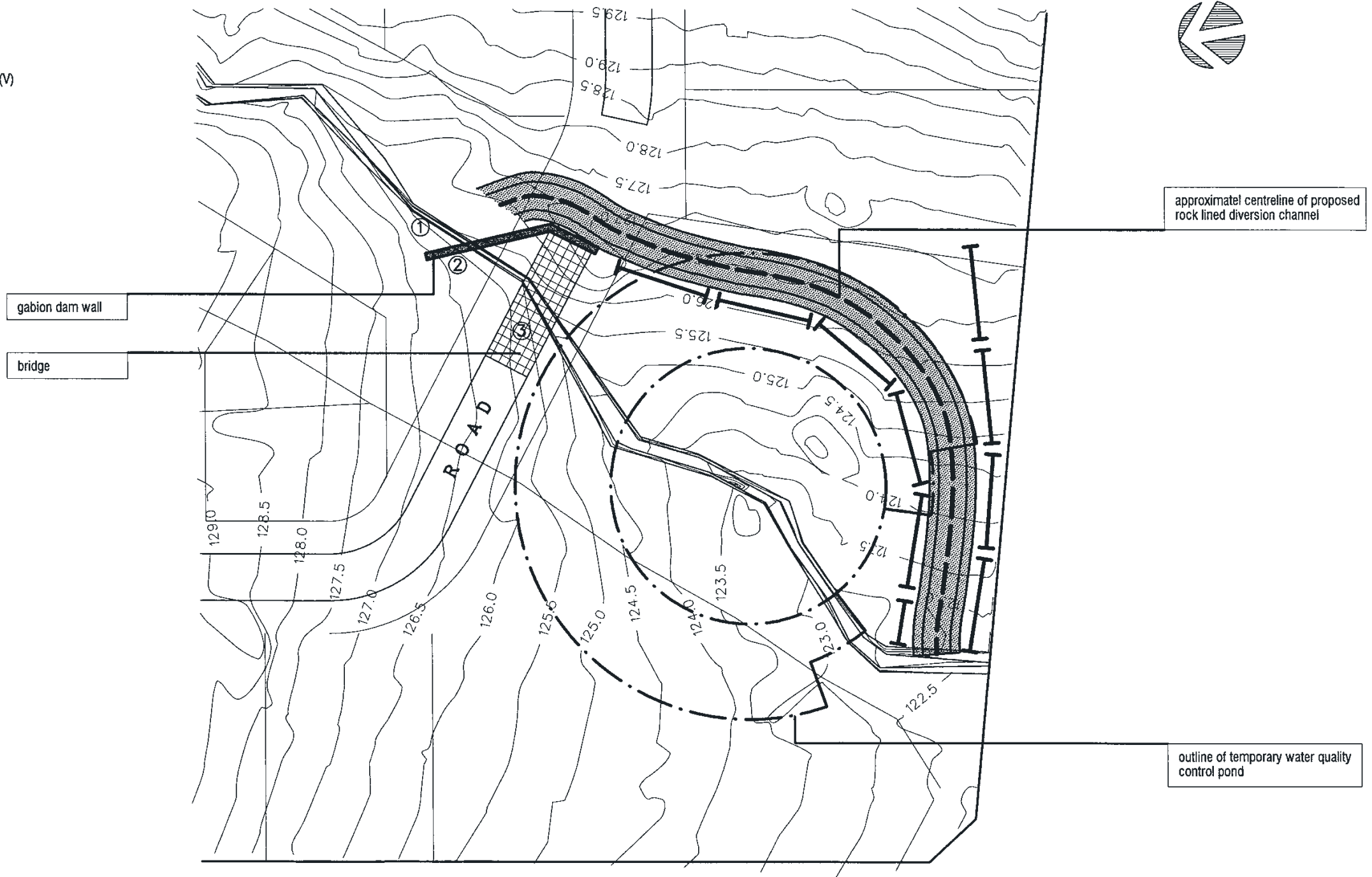
DETAIL - STAGE 3 AND 4

PLAN SOIL AND WATER MANAGEMENT PLAN		
PROJECT PROPOSED RESIDENTIAL DEVELOPMENT STONY DRIVE SUNSHINE HEIGHTS		
DRAWING SCALE 1:1000 @ A3	DRAWN I. Draw	CHECKED B. Neat
DATE September 2003		DRAWING No 922970-3



typical section

creek diversion
scale 1:100



approximate centreline of proposed rock lined diversion channel

gabion dam wall

bridge

outline of temporary water quality control pond

legend

	soil and water management
	sediment fence

levels

MARK	DESCRIPTION	R.L.
1	diversion channel invert - inlet	126.5
2	crest of diversion bank	127.0
3	deck of proposed bridge	126.5

DETAIL - STAGE 3

PLAN		
TEMPORARY CREEK DIVERSION		
PROJECT		
PROPOSED RESIDENTIAL DEVELOPMENT STONY DRIVE SUNSHINE HEIGHTS		
DRAWING SCALE	DRAWN	CHECKED
1:500 @ A3	I. Draw	B. Neat
DATE	DRAWING No	
September 2003	922970-4	

9. Urban Construction Sites

34. Construct Phase 2 of the WQCP (Sediment Basin 6) and stabilise any disturbed lands.
35. Upon completion of Sediment Basin 6 and stabilisation of all remaining disturbed lands, divert waters into it that had previously entered Sediment Basin 4.

Stage 4 Conditions (refer to Drawings 922970-3 and 922970-4).

36. Conditions 26 and 27 for Stage 2, above, apply to the whole of Stage 4.
37. Complete the roadworks east of the southern bridge, ensuring they do not hinder the flow of waters to Sediment Basin 6. This will probably require the construction of a culvert.
38. Connect Earth Banks 5 and 8, and 6 and 7 so that waters drain to Sediment Basins 5 or 6. Also, adjust the location of Earth Bank 9 to ensure that waters enter Sediment Basin 5.
39. Remove all sediment from Sediment Basins 1 and 2 and decommission them.

Stage 5 Conditions

40. Building works can be undertaken in this stage. It concludes after the lesser of:
 - a period of four years from the completion of Stage 4
 - 90 percent of the building works have been completed with associated disturbed lands stabilised.

During this Stage, the developer's responsibilities are limited to maintenance of the CDS device and Sediment Basins 5 and 6.

Stage 6 Conditions (refer to Drawing 922970-3).

41. Remove sediment from Sediment Basins 5 and 6 and decommission them. Decommission other temporary soil conservation works.
42. Where necessary, complete connections to the stormwater system (some aspects of this have been connected to temporary paths in earlier stages).
43. Complete works on the WQCP as shown on separate engineering drawings. This involves converting Sediment Basins 5 and 6 into wetlands, reconfiguring the inlets and outlets to the wetlands to meet the design criteria, and ensuring all site stormwater enters the GPT device (up to the design flow) and the WQCP sediment forebay.
44. Undertake final site stabilisation.

Erosion Control Conditions

45. Clearly visible barrier fencing shall be installed as shown on the SWMP and elsewhere at the discretion of the site superintendent to ensure traffic control and

-
- prohibit unnecessary site disturbance. Vehicular access to the site shall be limited to only those essential for construction work and they shall enter the site only through the stabilised access points.
46. Soil materials will be replaced in the same order they are removed from the ground. It is particularly important that all subsoils are buried and topsoils remain on the surface at the completion of works.
47. Where practicable, schedule the construction program so that the time from starting land disturbance activities to stabilisation is a duration of less than six months. Here stabilisation means achieving a C-factor of less than 0.1 and set in motion a program that should ensure it will drop permanently, by vegetation, paving, armouring, etc. to less than 0.05 within a further 60 days. Of course, local water restrictions might affect this in drought times.
48. Notwithstanding this, schedule works so that the duration from the conclusion of land shaping to completion of final stabilisation is less than 20 working days.
49. While C-factors are likely to rise to 1.0 during the work's program, they should not exceed those given in Table 9.7 in the long term. The requirements of Table 9.7 can be achieved as follows:
- (i) In areas of sheet flow, with a temporary vegetative cover and a suggested listing of suitable plant species is shown in Table 9.8 (note, these plants only protect the ground surface for up to six months). Where the plants suggested in Table 9.8 are used, lime amendments at rates of 4.0 kg/tonne of topsoil and 7.5 kg/tonne of subsoil will help surface stabilisation. Alternately, the area can be sprayed with a soil binder for protection up to 3 months duration using Terra-Control® or equivalent
 - (ii) In areas of concentrated water flow, with 350 gsm jute matting or equivalent, installed following SD 5-7 – see also Table 5.1 in Landcom (2004).
50. Lands recently established with grass species will be watered regularly until an effective cover has properly established and plants are growing vigorously. Further application of seed might be necessary later in areas of inadequate vegetation establishment.
51. Where practical, foot and vehicular traffic will be kept away from all recently stabilised areas.
52. Earth batters shall be constructed with as low a gradient as practical but not steeper than:
- 2(H):1(V) where slope length is less than 7 metres
 - 2.5(H):1(V) where slope length is between 7 and 10 metres
 - 3(H):1(V) where slope length is between 10 and 12 metres

9. Urban Construction Sites

Table 9.7 Maximum acceptable C-factors at Nominated Times During Works

Lands	Maximum C-factor	Remarks
Waterways and other areas subjected to concentrated flows, post construction	0.05	Applies after ten working days from completion of formation and before they are allowed to carry any concentrated flows. Flows will be limited to those shown in Table 5.1 of Landcom (2004). Foot and vehicular traffic will be prohibited in these areas (70% ground cover)
Stockpiles, post-construction	0.1	Applies after ten working days from completion of formation. Maximum C-factor of 0.10 equals 60% ground cover
All lands, including waterways and stockpiles during construction	0.15	Applies after 20 working days of inactivity, even though works might continue later. Maximum C-factor of 0.15 equals 50% ground cover

Table 9.8 Plant species for temporary cover

Sowing season	Seed mix
Autumn / Winter	oats @ 40 kg/ha Japanese millet @ 10 kg/ha
Spring / Summer	Japanese millet @ 20 kg/ha oats @ 20 kg/ha

-
- 4(H):1(V) where slope length is between 12 and 18 metres
 - 5(H):1(V) where slope length is between 18 and 27 metres
 - 6(H):1(V) where slope length is greater than 27 metres.

Slope length can be shortened by using low flow earth banks (SD 5.5) as catch drains.

53. Stockpiles (SD 4-1) will be located as shown on Drawings 922970-2 and 922970-3.
54. All earthworks, including waterways/drains/spillways and their outlets, will be constructed to be stable in at least the 10-year ARI time of concentration storm event.
55. During windy weather, large, unprotected areas will be kept moist (not wet) by sprinkling with water to keep dust under control. In the event water is not available in sufficient quantities, soil binders and/or dust retardants will be used or the surface will be left in a cloddy state that resists removal by wind.

Pollution Control Conditions

56. Notwithstanding Condition 54, stockpiles will not be located within 5 metres of hazard areas, including likely areas of high velocity flows such as waterways, paved areas and driveways.
57. Sediment fences (SD 6-8) will:
- (i) be installed where shown on Drawings 922970-1, 922970-2 and 922970-3 and elsewhere at the discretion of the site superintendent to contain the coarser sediment fraction (including aggregated fines) as near to as possible to their source;
 - (ii) have catchment areas not exceeding 1,030 square metres,
 - (iii) have returns of 1 metre upslope at intervals along the fences where the catchment areas exceed 1,030 square metres, to limit the discharge reaching each section to 50 litres per second in a maximum 10-year tc discharge.
58. The sediment retention basins (SD 6-4) will:
- (i) be constructed where shown on Drawings 922970-2 and 922970-3. They have been designed to a formula based on a design storm event (Attachment);
 - (ii) be flocculated (Appendix E, Landcom (2004)) before discharge occurs (unless the design storm event is exceeded); and
 - (iii) have one or more pegs placed on the floor to indicate clearly the level at which design capacity occurs and when sediment will be removed.
- Note: Capacities include an additional calculated amount to cater for sediment build up.

9. Urban Construction Sites

59. Stored contents of the basins will be treated with gypsum (Appendix E, Landcom (2004)) or other flocculating agents where they contain more than 50 mg/L of suspended solids. Treatment will be as follows:
- treat the waters and allow at least 24 hours to settle within four days from the conclusion of a rainfall event
 - drain the basins so that full storage capacity is regained without discharging sediment from the site within five days from the conclusion of a rainfall event.
60. Sediment removed from any trapping device will be disposed in locations where further erosion and consequent pollution to downslope lands and waterways will not occur.
61. Water will be prevented from directly entering the permanent drainage system unless it is relatively sediment free (i.e. the catchment area has been permanently landscaped and/or any likely sediment has been treated in an approved device). Nevertheless, stormwater inlets will be protected (SD 6-11 and SD 6-12).
62. Temporary soil and water management structures will be removed only after the lands they are protecting are stabilised.

Waste Management Condition

63. Acceptable bins will be provided for any concrete and mortar slurries, paints, acid washings, lightweight waste materials and litter. Clearance services will be provided at least weekly.

Site Inspection and Maintenance

(a) During Stages 1, 2, 3, 4 and 6

64. A self-auditing program will be established based on a Check Sheet. A site inspection using the Check Sheet will be made by the site manager:
- at least weekly
 - immediately before site closure
 - immediately following rainfall events greater than 5-mm in any one 24-hour period.

The self audit will include:

- recording the condition of every BMP employed
- recording maintenance requirements (if any) for each BMP
- recording the volumes of sediment removed from sediment retention systems, where applicable
- recording the site where sediment is disposed
- forwarding a signed duplicate of the completed Check Sheet to the project manager/developer for their information.

65. In addition, a suitably qualified person will be required to oversee the installation and maintenance of all soil and water management works on the site. The person will be required to spend a minimum of:

- (i) two hours onsite each fortnight during Stages 1, 2, 3, 4 and 6 and to provide a short monthly written report; and
- (ii) one-hour onsite each two months during Stage 5 to provide a short written report each four months.

The responsible person will ensure that:

- the Plan is being implemented correctly
- repairs are undertaken as required
- essential modifications are made to the Plan if and when necessary.

The report shall carry a certificate that certifies that works have been carried out following the approved plans.

66. Waste bins will be emptied as necessary. Disposal of waste will be in a manner approved by the Site Superintendent.

67. Proper drainage of the site will be maintained. To this end drains (including inlet and outlet works) will be checked to ensure that they are operating as intended, especially that:

- (i) no low points exist which can overtop in a large storm event;
- (ii) areas of erosion are repaired (e.g. lined with a suitable material) and/or velocity of flow is reduced appropriately through construction of small check dams or installing additional diversions upslope; and
- (iii) blockages are cleared (these might occur because of sediment pollution, sand/soil/spoil being deposited in or too close to them, breached by vehicle wheels, etc.).

68. Sand/soil/spoil materials placed closer than 2 metres from hazard areas will be removed. Such hazard areas include any areas of high velocity water flows (e.g. waterways and gutters), paved areas and driveways.

69. Recently stabilised lands will be checked to ensure that the erosion hazard has been effectively reduced. Any repairs will be initiated as appropriate.

70. Excessive vegetative growth will be controlled through mowing or slashing.

71. All sediment detention systems will be kept in good, working condition. In particular, attention will be given to:

- (i) recent works to ensure that they have not resulted in diversion of sediment laden water away from them;
- (ii) degradable products to ensure they are replaced as required; and

9. Urban Construction Sites

- (iii) sediment removal, to ensure the design capacity or less remains in the settling zone.
 - 72. Any pollutants removed from sediment basins or litter traps will be disposed in areas where further pollution to downslope lands and waterways should not occur.
 - 73. Additional erosion and/or sediment control works will be constructed as might become necessary to ensure the desired protection is given to downslope lands and waterways, i.e. make ongoing changes to the SWMP where it proves inadequate in practice or is subjected to changes in conditions at the work site or elsewhere in the catchment.
 - 74. Erosion and sediment control measures will be maintained in a functioning condition until all earthwork activities are completed and the site stabilised.
- (b) During Stage 1, 2, 3, 4, 5 and 6***
- 75. Waters in sediment retention basins that occupy more than one quarter of the design capacity will be:
 - (i) treated with a flocculating agent (Appendix E of Landcom (2004)); and
 - (ii) discharged within five days from the conclusion of any storm event large enough to fill the basin to that level.
 - 76. Litter, debris and coarse sediment will be removed from the gross pollutant traps and trash racks as required.

Attachment: Sediment Basin Calculations (construction phase)

This site in question has been divided into four subcatchments to better manage the control of erosion and sediment.

Sediment Basin 1 (northwest basin)

Catchment Characteristics

Total catchment area	=	0.72 ha
Disturbed catchment area	=	0.20 ha
RUSLE R-factor	=	2,500
Slope length	=	80 m
Slope gradient	=	10 %

Basin Volume

Basin volume = settling zone volume + sediment storage volume

Settling Zone Volume

The settling zone volume for Type D soils is calculated to contain all runoff expected from the 75th percentile, 5-day rainfall depth.

$$\text{Volume} = 10 \times C_v \times A \times R_{75\text{th ile, 5 day}}$$

Where:

- 10 is a unit conversion factor
- C_v is the volumetric runoff coefficient, defined as that portion of rainfall that runs off as stormwater over the 5-day period (0.5)
- R is the 5-day total rainfall depth (mm) that is not exceeded in 75 percent of rainfall events (18.6)
- A is area of catchment in hectares (ha) (0.72)

$$\begin{aligned}\text{Volume} &= 10 \times C_v \times A \times R_{75\text{th ile, 5 day}} \\ &= 10 \times 0.5 \times 0.72 \times 18.6 \\ &= 67 \text{ m}^3\end{aligned}$$

9. Urban Construction Sites

Sediment Storage Zone Volume

The sediment storage volume is normally taken as 50 percent of the capacity of the settling zone or as two months soil loss as calculated by the RUSLE, whichever is the larger. The settling zone volume is 67 m³ giving a potential sediment storage volume of 34 m³. However, two months (0.17 years) soil loss is:

$$\text{Sediment storage zone}_{\text{Type D}} = 0.17 A (R \times K \times LS \times P \times C) / 1.3 \text{ m}^3$$

Where:

- 0.17 is a factor to convert the annual calculated soil loss to the 2-month soil loss
- A is the disturbed area
- R is the RUSLE R-factor (2,500)
- K is the RUSLE K-factor (0.036)
- LS is the RUSLE LS-factor (2.81)
- P is the RUSLE P-factor (1.3)
- C is the RUSLE C-factor (1.0)
- 1.3 is a factor to convert tonnes to cubic metres, assuming a typical density of saturated sediment of 1.3

$$\begin{aligned}\text{Sediment storage zone}_{\text{Type D}} &= 0.17 \times 0.2 \times 2500 \times 0.036 \times 2.81 \times 1.3 \times 1.0 / 1.3 \\ &= 8.5 \text{ m}^3\end{aligned}$$

Total Basin Volume

$$\begin{aligned}\text{Total basin volume} &= \text{settling zone volume} + \text{sediment storage volume} \\ &= 67 + 34 \\ &= 101 \text{ m}^3\end{aligned}$$

Sediment Basin 2 (northeast basin)

Catchment Characteristics

Total catchment area	=	0.85 ha
Disturbed catchment area	=	0.30 ha
RUSLE R-factor	=	2,500
Slope length	=	80 m
Slope gradient	=	10 %

Basin Volume

$$\text{Basin volume} = \text{Settling zone volume} + \text{sediment storage volume}$$

Settling Zone Volume

The settling zone volume for *Type D* soils is calculated to contain all runoff expected from the 75th percentile, 5-day rainfall depth.

$$\text{Volume} = 10 \times C_v \times A \times R_{75\text{th ile, 5 day}}$$

Where:

- 10 is a unit conversion factor
- C_v is the volumetric runoff coefficient, defined as that portion of rainfall that runs off as stormwater over the 5-day period (0.5)
- R is the 5-day total rainfall depth (mm) that is not exceeded in 75 percent of rainfall events (18.6)
- A is area of catchment in hectares (ha) (0.85)

$$\begin{aligned}\text{Volume} &= 10 \times C_v \times A \times R_{75\text{th ile, 5 day}} \\ &= 10 \times 0.5 \times 0.85 \times 18.6 \\ &= 79 \text{ m}^3\end{aligned}$$

Sediment Storage Zone Volume

The sediment storage volume is normally taken as 50 percent of the capacity of the settling zone or as two months soil loss as calculated by the RUSLE, whichever is the larger. The settling zone volume is 79 m³ giving a potential sediment storage volume of 40 m³. However, two months (0.17 years) soil loss is:

9. Urban Construction Sites

$$\text{Sediment storage zone}_{\text{Type D}} = 0.17 A (R \times K \times LS \times P \times C) / 1.3 \text{ m}^3$$

Where:

- 0.17 is a factor to convert the annual calculated soil loss to the 2-month soil loss
- A is the disturbed area
- R is the RUSLE R-factor (2,500)
- K is the RUSLE K-factor (0.036)
- LS is the RUSLE LS-factor (2.81)
- P is the RUSLE P-factor (1.3)
- C is the RUSLE C-factor (1.0)
- 1.3 is a factor to convert tonnes to cubic metres, assuming a typical density of saturated sediment of 1.3

$$\begin{aligned}\text{Sediment storage zone}_{\text{Type D}} &= 0.17 \times 0.3 \times 2500 \times 0.036 \times 2.81 \times 1.3 \times 1.0 / 1.3 \\ &= 12.7 \text{ m}^3\end{aligned}$$

Total Basin Volume

$$\begin{aligned}\text{Total basin volume} &= \text{settling zone volume} + \text{sediment storage volume} \\ &= 79 + 40 \\ &= 119 \text{ m}^3\end{aligned}$$

Sediment Basin 3 (southwest basin)

Catchment Characteristics

Total catchment area	=	1.14 ha
Disturbed catchment area	=	0.60 ha
RUSLE R-factor	=	2,500
Slope length	=	80 m
Slope gradient	=	10 %

Basin Volume

Basin volume = settling zone volume + sediment storage volume

Settling Zone Volume

The settling zone volume for Type D soils is calculated to contain all runoff expected from the 75th percentile, 5-day rainfall depth.

$$\text{Volume} = 10 \times C_v \times A \times R_{75\text{th ile, 5 day}}$$

Where:

- 10 is a unit conversion factor
- C_v is the volumetric runoff coefficient, defined as that portion of rainfall that runs off as stormwater over the 5-day period (0.5)
- R is the 5-day total rainfall depth (mm) that is not exceeded in 75 percent of rainfall events (18.6)
- A is area of catchment in hectares (ha) (1.14)

$$\begin{aligned}\text{Volume} &= 10 \times C_v \times A \times R_{75\text{th ile, 5 day}} \\ &= 10 \times 0.5 \times 1.14 \times 18.6 \\ &= 106 \text{ m}^3\end{aligned}$$

Sediment Storage Zone Volume

The sediment storage volume is normally taken as 50 percent of the capacity of the settling zone or as two months soil loss as calculated by the RUSLE, whichever is the larger. The settling zone volume is 106 m^3 giving a potential sediment storage volume of 53 m^3 . However, two months (0.17 years) soil loss is:

9. Urban Construction Sites

$$\text{Sediment storage zone}_{\text{Type D}} = 0.17 A (R \times K \times LS \times P \times C) / 1.3 \text{ m}^3$$

Where:

0.17 is a factor to convert the annual calculated soil loss to the 2-month soil loss

A is the disturbed area

R is the RUSLE R-factor (2,500)

K is the RUSLE K-factor (0.036)

LS is the RUSLE LS-factor (2.81)

P is the RUSLE P-factor (1.3)

C is the RUSLE C-factor (1.0)

1.3 is a factor to convert tonnes to cubic metres, assuming a typical density of saturated sediment of 1.3

$$\begin{aligned}\text{Sediment storage zone}_{\text{Type D}} &= 0.17 \times 0.6 \times 2,500 \times 0.036 \times 2.81 \times 1.3 \times 1.0 / 1.3 \\ &= 25.3 \text{ m}^3\end{aligned}$$

Total Basin Volume

$$\begin{aligned}\text{Total basin volume} &= \text{settling zone volume} + \text{sediment storage volume} \\ &= 106 + 53 \\ &= 159 \text{ m}^3\end{aligned}$$

Sediment Basin 4 (southeast basin)

Catchment Characteristics

Total catchment area	=	1.29 ha
Disturbed catchment area	=	1.0 ha
RUSLE R-factor	=	2,500
Slope length	=	80 m
Slope gradient	=	10 %

Basin Volume

Basin volume = settling zone volume + sediment storage volume

Settling Zone Volume

The settling zone volume for *Type D* soils is calculated to contain all runoff expected from the 75th percentile, 5-day rainfall depth.

$$\text{Volume} = 10 \times C_v \times A \times R_{75\text{th ile, 5 day}}$$

Where:

- 10 is a unit conversion factor
- C_v is the volumetric runoff coefficient, defined as that portion of rainfall that runs off as stormwater over the 5-day period (0.5)
- R is the 5-day total rainfall depth (mm) that is not exceeded in 75 percent of rainfall events (18.6)
- A is area of catchment in hectares (ha) (1.29)

$$\begin{aligned}\text{Volume} &= 10 \times 0.5 \times 1.29 \times 18.6 \\ &= 120 \text{ m}^3\end{aligned}$$

Sediment Storage Zone Volume

The sediment storage volume is normally taken as 50 percent of the capacity of the settling zone or as two months soil loss as calculated by the RUSLE, whichever is the larger. The settling zone volume is 120 m³ giving a potential sediment storage volume of 60 m³. However, two months (0.17 years) soil loss is:

9. Urban Construction Sites

$$\text{Sediment storage zone Type D} = 0.17 A (R \times K \times LS \times P \times C) / 1.3 \text{ m}^3$$

Where

0.17 Is a factor to convert the annual calculated soil loss to the 2-month soil loss

A is the disturbed area

R is the RUSLE R-factor (2,500)

K is the RUSLE K-factor (0.036)

LS is the RUSLE LS-factor (2.81)

P is the RUSLE P-factor (1.3)

C is the RUSLE C-factor (1.0)

1.3 is a factor to convert tonnes to cubic metres, assuming a typical density of saturated sediment of 1.3

$$\begin{aligned}\text{Sediment storage zone Type D} &= 0.17 \times 1.0 \times 2500 \times 0.036 \times 2.81 \times 1.3 \times 1.0 / 1.3 \\ &= 42.2 \text{ m}^3\end{aligned}$$

Total Basin Volume

$$\begin{aligned}\text{Total basin volume} &= \text{settling zone volume} + \text{sediment storage volume} \\ &= 120 + 60 \\ &= 180 \text{ m}^3\end{aligned}$$



Chapter 10
BIBLIOGRAPHY

10. Bibliography

Abraham, S.M. and Abraham, N.A. (Eds.) (1996). *The Soil Data System Site and Profile Information Handbook* (Second Edition). Department of Infrastructure Planning and Natural Resources, Sydney.

ANZECC (2000). *Australian Water Quality Guidelines for Fresh and Marine Waters*. Australian and New Zealand Environment and Conservation Council, Canberra.

Australian Natural Resources Atlas (2001). Available from CSIRO Land and Water, Canberra at http://audit.ea.gov.au/ANRA/atlas_home.cfm.

Australian Plant Study Group (1980). *Grow What Where*. Thomas Nelson, Melbourne.

Aveyard, J.M. (Ed.) (1982). *Design Manual for Soil Conservation Works*. Technical Handbook No. 5. Department of Infrastructure Planning and Natural Resources, Sydney.

Beadle, N.C.W., Evans, O.D. and Carolin, R.C. (1986). *Flora of the Sydney Region* (Revised Edition). Reed Books, Frenchs Forest, Sydney.

Beca Carter Hollings & Ferner Ltd (2003). Report TP90 Flocculation Guidelines. Auckland Regional Council, Auckland.

Black, C.A. (Ed.) (1965). *Methods of Soil Analysis*. (Two vols). American Society of Agronomy, Inc., Madison, Wisconsin.

Blamey, N. (1987). *Walking Track Management Manual*. Department of Lands, Parks and Wildlife, Tasmania.

Bohan, J.P. (1970). *Erosion and Riprap Requirements at Culvert and Storm-Drain Outlets*. Hydraulic Laboratory Investigation, US Army Engineer Waterways Experiment Station, Mississippi.

Bond, R., Craze, B., Rayment, G. and Higginson, F.R. (1987). *Australian Soil and Land Survey Laboratory Handbook*. Inkata Press, Melbourne.

Brown, M., Mackay, P., Young, C. and White, G.C. (1996). "Community Involvement and Participation in Stormwater Constructed Wetland Systems", in proceedings of Water Technology Conference, Sydney, 27-28 May 1996.

California Stormwater Quality Task Force (1993) "California Stormwater Construction Activity Best Management Practice Handbook".

Casagrande, A. (1947). "Classification and identification of soils". *Proceedings of the American Society of Civil Engineers*, 73: 783-810.

Chapman, G.A. and Atkinson, G. (2000). "Soil Survey and Mapping". In Charman, P.E.V. and Murphy, B.W. (Eds.). *Soils – Their Properties and Management: A Soil Conservation Handbook for New South Wales*. Sydney University Press, Sydney.

Chapman, G.A. and Murphy, C.L. (1989). *Soil Landscapes of the Sydney 1:100,000 Sheet*. Department of Infrastructure, Planning and Natural Resources, Sydney.

Charman, P.E.V. and Murphy, B.W. (Eds.) (2000). *Soils: Their Properties and Management*. Oxford University Press, South Melbourne.

Constandopoulos, J. and Clark, P. (1996). "Pollutant Load Retention Curves for a Sydney Stormwater Water Pollution Control Pond at Mt. Annan", in *Proceedings of the 4th Annual Conference on Soil and Water Management for Urban Development*, 9-13 September 1996, Sydney.

Corps of Engineers (1953). "The Unified Soil Classification System". Technical Memorandum 3-357, Volumes 1 and 2. Corps of Engineers, US Army.

CSIRO (1983). *Soils: An Australian Viewpoint*. CSIRO, Division of Soils, Melbourne, in association with Academic Press, London.

DEC (in prep.). *Managing Urban Stormwater: Council Handbook*. Department of Environment and Conservation, Sydney.

DEC (in prep.). *Managing Urban Stormwater: Treatment Techniques* (2nd edition). Department of Environment and Conservation, Sydney.

DEC (in prep.). *Managing Urban Stormwater: Urban Design*. Department of Environment and Conservation, Sydney.

Dent, R. and Young, A. (1981). *Soil Survey and Land Evaluation*. George Allen and Unwin, London.

Department of Housing (1993). *Soil & Water Management for Urban Development* (Second Edition). NSW Department of Housing, Sydney.

Department of Housing (1993-94). *Guidelines for Plant Selection in New South Wales*. Volumes 1 to 5, NSW Department of Housing, Sydney.

10. Bibliography

Department of Main Roads (2002). *Road Drainage Design Manual*. Queensland Government, Department of Main Roads, Brisbane.

Derrick, D.L. (1996). "The Bendway Weir: An In-stream Erosion Control and Habitat Improvement Structure for the 1990s", in Proceedings of Conference XXVII of the International Erosion Control Association: Erosion Control Technology – Bringing it Home, 27 February to 1 March 1996, Seattle, Washington.

DLWC (1998). *The Constructed Wetlands Manual*. Department of Infrastructure Planning and Natural Resources, Sydney.

DLWC (1994/5). Various "RiverWise" pamphlets. Department of Infrastructure Planning and Natural Resources, Sydney.

DLWC (1997). "Soil and Landscape Issues in Environmental Impact Assessment". Technical Report No. 34, Department of Infrastructure Planning and Natural Resources, Sydney.

Dunkerley, G. (1995). "Using Wetlands to Treat Wastewater: NSW EPA Guidelines", in proceedings of a national conference on *Wetlands for Water Quality Control*, James Cook University, Townsville, 25-29 September, 1995.

Dwyer, P. and Kidd, R. (1993). *Erosion and Sediment Control – Model Policy and Code of Practice*. Department of Infrastructure Planning and Natural Resources, Sydney.

Emerson, W.W. (1967). "A classification of soil aggregates based on their coherence in water". *Australian Journal of Soil Resources*, 5: 47-57

EPA (1997b). *Managing Urban Stormwater: Treatment Techniques*. NSW Department of Environment and Conservation, Sydney. [Revised edition to be published by the DEC in 2004 or 2005]

EPA (1997c). *Environmental Guidelines: Use and Disposal of Biosolids Products*. NSW Department of Environment and Conservation, Sydney.

ESD Steering Committee (1992). *National Strategy for Ecologically Sustainable Development*. Commonwealth of Australia, Canberra.

Fifield, G.S. (2001a). *Designing for Effective Sediment and Erosion Control on Construction Sites*. Forester Press, Santa Barbara, California, USA.

Fifield, G.S. (2001b). *Field Manual on Sediment and Erosion Control Best Management Practices for Contractors and Inspectors*. Forester Press, Santa Barbara, California, USA.

Foster, G.R., McCool, D.K., Renard, K.G. and Moldenhauer, W.C. (1981). "Conversion of the universal soil loss equation to SI metric units". *Journal of Soil and Water Conservation*, 36: 335-360.

Freebairn, D.M., Silburn, D.M. and Loch, R.J. (1989). "Evaluation of three soil erosion models for clay soil". *Australian Journal of Soil Research*, 27:199-211

Freeman, G., Howells, L. (1995). "Saline Flocculation in Stormwater Quality Management", in Proceedings of the 3rd Annual conference on Soil and Water Management Development for Urban Development, 12-15 September 1995, Sydney.

Geeves, G.W., Craze, B. and Hamilton, G.J. (2000). "Soil Physical Properties". In Charman, P.E.V. and Murphy, B.W. (Eds.), *Soils – Their Properties and Management: A Soil Conservation Handbook for New South Wales*. Sydney University Press, Sydney.

Goldman, S.J., Jackson, K. and Bursztynsky, T.A. (1986). *Erosion and Sediment Control Handbook*. McGraw-Hill, New York.

Goldrick, D.A. and Armstrong, J.L. (1994). "The impact of urban development on water quality at Albion Park, Wollongong", in Proceedings of the 2nd Annual Conference on Soil & Water Management for Urban Development, Sydney, 6-7 September 1994.

Goldrick, D.A. Yassini, I. and Jones, B.G. (1996). "Flocculation behaviour of West Dapto and Albion Park soils types in urban runoff treatments", in Proceedings of the 4th Annual Conference on Soil & Water Management for Urban Development, Sydney, 9-13 September 1996.

Gray, J.M. and Murphy, B.W. (1999). *Parent Material and Soils: A Guide to the Influence of Parent Material on Soil Distribution in Eastern Australia*. Department of Infrastructure Planning and Natural Resources Sustainable Land and Coastal Management (Information and Planning) Branch, Sydney.

Gunn, R.H., Beattie, J.A., Reid, T.E. and van de Graff, R.H.M. (Eds.) (1988). *Australian Soil and Land Survey Handbook: Guidelines for Conducting Surveys*. Inkata Press, Melbourne.

Handreck, K.A. and Black, N.D. (1989). *Growing Media for Ornamental Plants and*

10. Bibliography

Turf. New South Wales University Press, Kensington, Sydney.

Hazelton, P.A. (Ed.) (1992). *Bibliography of the Soils of Sydney and Adjacent Regions*. Australian Society of Soil Science Inc (NSW Branch), Sydney.

Hazelton, P.A. and Murphy, B.W. (Eds.) (1992). *What do all the Numbers Mean? A Guide for the Interpretation of Soil Test Results*. Department of Infrastructure Planning and Natural Resources, Sydney.

Healthy Rivers Commission (2002). *Independent Inquiry into Coastal Lakes: Final Report*. Healthy Rivers Commission of New South Wales

Hornsby Council (1994). *Urban Runoff Management Code and Soil and Water Management Code*. Hornsby Shire Council.

Houghton, P.D. and Charman P.E.V. (1986). *Glossary of Terms Used in Soil Conservation*. Department of Infrastructure Planning and Natural Resources, Sydney.

Hunt, J.S. (Ed.) (1992). *Urban Erosion and Sediment Control*. Department of Infrastructure Planning and Natural Resources, Sydney.

Illawarra TCM Committee (1989). "Draft Soil and Water Guidelines and Specifications for Urban, Industrial and Resort Developments". Total Catchment Management Committee of Lake Illawarra, Wollongong.

IEA, Queensland Division (1996). *Soil Erosion and Sediment Control: Engineering Guidelines for Queensland Construction Sites*. Institution of Engineers, Australia (Queensland Division), Brisbane.

IEA (2003), *Australian Rainfall Quality* (draft). Institution of Engineers, Australia, Canberra.

Isbell, R.F. (1996). *The Australian Soil Classification*. CSIRO Publishing, Collingwood, Vic.

Israelson *et al* (1980). *Erosion Control During Highway Construction: Manual on Principles and Practices*, Report 221.

Karsees, L. and Prosser, I. (2001). "The Application of the RUSLE as a Risk Assessment Tool in Site Specific Projects", in *Proceedings of the 9th Annual Conference on Soil and*

Water Management, 20-23 November 2001. Australasian Chapter of the International Erosion Control Association, Picton, NSW.

Lancaster, T. (1997). "Texas Department of Transportation Releases Results of 1996 Channel Lining Tests". Newsletter of North American Green Technical Services, Volume 2, Issue 1, April 1997.

Lawrence, A.I. (1986). "Source and fate of urban runoff constituents and their management", in Proceedings of a Symposium on Stormwater Quality in Urban Areas. Water Research Foundation, Illawarra Region, Wollongong.

Leys, John (1991). "The role of trees in providing shelter to crops and controlling erosion". In Proceedings of Conference on The Role of Trees in Sustainable Agriculture, Albury, 30 September to 3 October 1991.

Livingston, E.H., McCarron, E., Cox, J. and Sanzone, P. (1988). *The Florida Development Manual: A Guide to Sound Land and Water Management*. Florida Department of Environmental Regulation, Tallahassee, Florida, USA.

Loch, R.J. and Rosewell, C.J. (1992). "Laboratory methods for measurement of soil erodibilities (K-factors) for the Universal Soil Loss Equation". *Australian Journal of Soil Research*, 30: 233-248.

Maryland Department of the Environment (1984). Standards and Specifications for Infiltration Practices. Annapolis, Maryland.

McDonald, R.C., Isbell, R.F., Speight, J.G., Walker, J. and Hopkins, M.S. (1990). *Australian Soil and Land Survey Field Handbook*. Inkata Press, Melbourne.

McFarlane, D.J., Davies, R.J. and Westcott, T. (1986). "Rainfall erosivity in Western Australia", in Proceedings of Hydrology and Water Resources Symposium, Griffith University, Brisbane. Institution of Engineers, Australia.

McLaughlin, R.A. (2002). "Measures to Control Erosion and Turbidity in Construction Site Runoff: Final Report". Soil Science Department, North Carolina State University, Raleigh, North Carolina.

Metcalf, P. (2001). "The performance of chemically treated sediment retention ponds", in Proceedings of the 9th Annual Conference of the Australasian Chapter of the International Erosion Control Association on Soil and Water Management, Gold Coast, 20-23 September 2001.

10. Bibliography

Meyer, L.D. and Ports, M.A. (1976). "Prediction and Control of Urban Erosion and Sedimentation" in Proceedings from the National Symposium on Urban Hydrology, Hydraulics and Sediment Control – a mini-course held at the University of Kentucky, Lexington, Kentucky, 26-29 July 1976: 323-331.

Mills, J.J., Murphy, B.W. and Wickham, H.G. (1980). "A Study of Three Simple Laboratory Tests for the Prediction of Soil Shrink-swell Behaviour". *Journal of the Soil Conservation Service of NSW*, 36: 77-82.

Morisawa, M. (1968). *Streams, Their Dynamics and Morphology*. McGraw-Hill Book Company, Sydney.

Morse, R. (2001). "Application of Soils Data to Urban Erosion and Sediment Control Programs". In Cattle, S.R and George, B.H. (Eds.), *Describing, Analysing and Managing Our Soil*. Proceedings of the DAMOS 1999 workshop held at The University of Sydney, 22-26 November 1999. Published jointly by The University of Sydney and the Australian Society of Soil Science Inc. (NSW Branch), pp285–306.

Morse, R.J., Chapman, G.A. and Hird, C. (1992). "Specific Urban Land Capability Assessment", in Proceedings of the 7th International Soil Conservation Organisation Conference, Sydney, 27-30 September 1992.

Morse, R.J., Lang, D. and McVey G.C. (1990). "Vegetative Erosion Control", in Proceedings of a seminar on Vegetation and Landscaping in Water Engineering. Institution of Engineers, Australia, Sydney, 11 September 1990.

Morse, R.J., Mitchell, P.B., Hird, C., Chapman, G.A. and Lawrie, R. (1991). "Assessment of soil limitations in Environmental Impact Statements". *Australian Journal of Soil and Water Conservation*, 4(2): 12-17.

Morse, R.J. and Rosewell, C. (1993). "Application of the USLE to Classifying Urban Lands", in Proceedings of the 24th Annual Conference of the International Erosion Control Association, Indianapolis, Indiana, 23-26 February 1993: 169-184.

Morse, R.J. and Rosewell, C. (1996). "Use of the USLE as a Tool in the Management of Urban Lands", in Proceedings of the 4th Annual IECA (Australasia) and SIA Conference on Soil and Water Management for Urban Development, Sydney, 9-13 September 1996.

Murphy, B.W. (1984). "A scheme for the Field Assessment of Soil Erodibility for Water Erosion". Wellington Research Centre Technical Paper 19/84. NSW Department of Infrastructure Planning and Natural Resources, Sydney.

MWRA (1983). 1983 Maryland Standards and Specifications for Soil Erosion and Sediment Control. Maryland Water Resources Administration, United States Soil Conservation Service and State Soil Conservation Service. MWRA, Annapolis, Maryland, USA

Newman, P. (1996). "Issues in urban development: lessons at home and abroad". Waring, S.A. (Ed.). Invited lecture on "Land Management for Urban Development" held in Brisbane 22-24 April 1996 by the Australian Society of Soil Science Inc.

Northcote, K.H., Hubble, G.D., Isbell, R.F., Thompson, C.H. and Bettenay, E. (1975). *A Description of Australian Soils*. CSIRO, Melbourne.

Northcote, K.H. (1978). "Soils". In *Atlas of Australian Resources*. Third Series. Volume 1, Soils and Land Use. Division of National Mapping, Canberra.

Northcote, K.H. (1979). *A Factual Key for the Recognition of Australian Soils*. Rellim Technical Publications, Adelaide.

NSW Government (2001). *Floodplain Management Manual: The Management of Flood Liable Land*. New South Wales Government, Sydney.

Ontario Ministry of Environment and Energy (1994). *Stormwater Management Practices Planning and Design Manual*. Marshall Macklin Monaghan Ltd, Toronto.

Pilgrim, D.H. (Ed.) (1998). *Australian Rainfall and Runoff: A Guide to Flood Estimation*. Volume 1. Institution of Engineers, Australia.

Power, G.A. (1987). *Land Rehabilitation Manual*. Soil Conservation Service of NSW and Penrith Lakes Development Corporation.

Rayment, G.E. and Higginson, F.R. (1992). *Australian Laboratory Handbook of Soil and Water Chemical Methods*. Inkata Press, Melbourne.

Renard, K.G., Foster, G.R., Weeies, G.A. and Porter, J.P. (1991). "RUSLE: Revised Universal Soil Loss Equation". *Journal of Soil & Water Conservation*, 1991: 30-33.

Renard, K.G., Foster, G.R., Weeies, G.A., McCool, D.K. and Yoder, D.C.

10. Bibliography

(Coordinators) (1997). "Predicting Soil Erosion by Water: A guide to conservation planning with the Revised Universal Soil Loss Equation (RUSLE)". USDA Handbook 703, US Department of Agriculture, Washington D.C.

Ritchie, J.A. (1963) . "Earthwork Tunnelling and the Application of Soil Testing Procedures". *Journal of the Soil Conservation Service of NSW*, 19: 111-129.

Rosenthal, K.M. and White, B.J. (1980). "Distribution of rainfall index in Queensland". Report 80/8, Department of Primary Industry, Brisbane.

Rosewell, C.J. (1993a). Estimation of rainfall erosivity. *Erosion Research Newsletter No. 11*. Department of Infrastructure Planning and Natural Resources, Sydney.

Rosewell, C.J. (1993b). "SOILOSS-A program to assist in the selection of management practices to reduce erosion" (Second Edition). *Technical Handbook No. 11*. Department of Infrastructure Planning and Natural Resources, Sydney.

Rosewell, C.J. (1997). "Potential source of sediments and nutrients: Sheet and rill erosion and phosphorus sources." *Australia: State of the Environment Technical Paper Series (Inland Waters)*. Department of the Environment, Sport and Territories, Canberra.

Rosewell, C.J. and Loch, R.J. (2002). "Estimation of the RUSLE Soil Erodibility Factor". In: *Soil Physical Measurements and Interpretation for Land Evaluation* (Editors N. McKenzie, K. Coughlan and H. Cresswell). Australian soil and land survey handbook series; Vol.5 CSIRO Publishing.

Rosewell, C.J. and Turner, J.B. (1992). Rainfall erosivity in New South Wales. *CaLM Technical Report No. 20*. Department of Infrastructure Planning and Natural Resources, Sydney.

Sheridan, G.J. and Rosewell, C.J. (2003). "An improved Victorian erosivity map". *Australian Journal of Soil Research*, 41: 141-149.

Singer, M.J., Janitzky, P. and Blackard, J. (1982). "The influence of exchangeable sodium percentage on soil erodibility". *Soil Science Society of America Journal*, 46: 117-121.

Soil Conservation Service of NSW (1985). *Guidelines for Selection, Establishment and Maintenance of Recreation Vehicle Areas*. Department of Infrastructure Planning and Natural Resources, Sydney.

SPCC (1980). *An Atlas of Classified Water in New South Wales*. Department of Environment and Conservation, Sydney.

SPCC (1983). *Environmental Audit of Lake Macquarie*. Department of Environment and Conservation, Sydney.

Stace, H.C.T., Hubble, G.D., Brewer, R., Northcote, K.H., Sleemen, J.R., Mulcahy, M.J. and Hallsworth, E.G. (1968). *A Handbook of Australian Soils*. Rellim Technical Publications, Adelaide.

Stewart, J. (1955). "Spacing of graded banks". *Journal of Soil Conservation, NSW*, 11: 165-171.

Stone, Y., Ahern, C.R. and Blunden, B. (1998). *Acid Sulfate Soils Manual*. Acid Sulfate Management Advisory Committee, Wollongbar.

Stone, Y. and Hopkins, G. (1998). *Acid Sulfate Soil Planning Guidelines*. Acid Sulfate Soil Management Advisory Committee, Wollongbar.

Stone, Y., Ahern, C.R. and Blunden, B. (1998). *Acid Sulfate Soil Manual 1998*. Acid Sulfate Soil Management Advisory Committee, Wollongbar.

Sydney Coastal Councils Group (1995). *Urban Stormwater Management Model Policies and Guidelines*. Prepared by Bewsher Consulting, Morse McVey & Associates, Fairfield City Council and Geoffrey O'Loughlin, SCCG, Sydney.

Temple, J.M. and Bungey, D. (1980). *Revegetation: Methods and Management*. State Pollution Control Commission, Sydney.

Tobiason, S., Jenkins, D., Molash, E. and Rush S. (2001). "Polymer Use and Testing for Erosion and Sediment Control on Construction Sites". *Erosion Control*, 8 (1): 90-101.

Tomlinson, G.W., Fisher, A.G. and Clark, R.D.S. (1993). *The Paddocks*, EWS Report No. 93/11, Hydrology Unit, Water Resources Branch, South Australian Engineering and Water Supply Department, Adelaide.

URS Greiner Woodward Clyde (1999). *Soil Stabilisation for Temporary Slopes*. Report prepared for State of California Business, Transportation and Housing Agency. Contract No. 43A0004C, Task Order No. 17.

10. Bibliography

USDA (1968). Roads Handbook. USDA Handbook No. 2310. United States Department of Agriculture, Forest Service, Washington, D.C.

USDA (1975). *Standards and Specifications for Soil Erosion and Sediment Control in Developing Areas*. United States Department of Agriculture, Soil Conservation Service, College Park, Maryland.

USDA (1983). *National Soils Handbook*. 430-VI-NSH, July 1983, Part 603. United States Department of Agriculture, Washington, D.C.

USDA (1993). Soil Survey Manual. USDA Handbook No. 18. United States Department of Agriculture, Washington, D.C.

USDA (1996). *National Catalogue of Erosion and Sediment Control and Storm Water Management: Guidelines for Community Assistance*. United States Department of Agriculture Natural Resources Conservation Service, Washington, D.C.

US Dept Transportation (1975). "Hydraulic Design for Energy Dissipaters for Culverts and Channels". United States Department of Transportation, Federal Highway Administration, Hydraulic Engineering Circular No. 14, Washington, D.C.

US Dept Transportation (1975b). "Design of Stable Channels with Flexible Linings". United States Department of Transportation, Federal Highway Administration, Hydraulic Engineering Circular No. 15, Washington, D.C.

US EPA (1983). Results of the Nationwide Urban Runoff Program, Volume 1, Final Report. US Environmental Protection Agency, Water Planning Division, Washington, D.C.

Virginia SWCC (1980). *Virginia Erosion and Sediment Control Handbook*. Virginia Soil and Water Conservation Commission, Richmond, Virginia.

Whelans, Halpern Glick Maunsell, Thompson Palmer, Murdoch University (1994). *Planning and Management Guidelines for Water Sensitive Urban (Residential) Design*. Prepared for Department of Planning and Urban Development, Water Authority of Western Australia and the WA Environment Protection Authority.

Whitehead, E. (1976). "A Guide to the Use of Grass in Hydraulic Engineering Practice". Technical Note 71, Construction Industry Research and Information Association, London.

Williams, J.R. (1975). "Sediment-yield prediction with Universal Equation using runoff energy factor", in *Present and Prospective Technology for Predicting Sediment Yields and sources*. ARS-S-40, USDA-ARS, pp. 244-252

Willing and Partners Pty Ltd (1992). *Design Guidelines for Gross Pollutant Traps*. Prepared for ACT Department of Environment, Land and Planning and the Department of Urban Services, Canberra.

Wischmeier, W.H. and Smith, D.D. (1978). *Predicting Rainfall Erosion Losses – A Guide to Conservation Planning*. United States Department of Agriculture, Agriculture Handbook No. 537. United States Government Printing Office, Washington, D.C.

Wrigley, J.W. and Fagg, M. (1983). *Australian Native Plants*. Collins, Sydney.

Yu, B. (1998). "Rainfall erosivity and its estimation for Australia's tropics". *Australian Journal of Soil Research* 36: 143-165.

Yu, B. and Rosewell, C.J. (1996a). "An assessment of a daily rainfall erosivity model for New South Wales". *Australian Journal of Soil Research* 34: 139-152.

Yu, B. and Rosewell, C.J. (1996b). "Rainfall erosivity estimation using daily rainfall amounts for South Australia". *Australian Journal of Soil Research*, 34: 721-733.

Yu, B. and Rosewell, C.J. (2001). "Evaluation of WEPP for runoff and soil loss prediction at Gunnedah, NSW, Australia". *Australian Journal of Soil Research*, 39: 1131-1145.



APPENDIX A

A1 Revised Universal Soil Loss Equation

While assessment of runoff is commonplace in the urban planning process, estimating possible soil loss is not. Nonetheless, estimates of soil loss have four important applications to soil and water management. These are to:

- assess the erosion risk at a site
- identify suitable measures to overcome the erosion risk
- estimate the required capacity of sediment retarding basins
- compare the effectiveness of various erosion control measures.

Therefore, by estimating likely soil loss levels, land planners can gear erosion and sediment control measures to each part of any development site. Consequently, they can mitigate possible soil erosion and consequent sediment pollution to downslope lands and waterways.

The Revised Universal Soil Loss Equation (RUSLE) is designed to predict the long term, average, annual soil loss from sheet and rill flow at nominated sites under specified management conditions. The predicted losses are empirically derived and it is anticipated that the monitoring and comparison of actual soil loss onsite measured against that calculated will lead to a substantiation of the equation. Further validations of this methodology on construction sites are still being investigated. The original application is described by Wischmeier and Smith (1978) and revised by Renard, Foster, Weesies and Porter (1991) and Renard, Foster, Weesies, McCool and Yoder (1997). It has been adapted to urban sites by Goldman *et al.*, (1986) and modified for Australian conditions in a computer program called SOILOSS (Rosewell, 1993b). The equation is represented by:

$$A = R K L S P C \dots\dots\dots \text{Equation (1)}$$

where, A = computed soil loss (tonnes/ha/yr)^[1]

R = rainfall erosivity factor

K = soil erodibility factor

LS = slope length/gradient factor

P = erosion control practice factor

C = ground cover and management factor.

Because the RUSLE takes into consideration all major components likely to affect sheet erosion, it is the most widely used (and abused) soil loss equation available. While it does have great practical value, its limitations should be recognised and understood.

1. In the urban context, it can be assumed that soil loss derived from the RUSLE is equal to the sediment flux into a sediment retardation basin located on, or immediately next to a site, and the volume of sediment entering within a year is:

$$\text{Volume (m}^3\text{)} = \frac{\text{mass of dry delivered sediment}}{\text{density of saturated sediment}}$$

The main limitations of the RUSLE are that:

- (i) It only predicts sediment entrained in the erosion process and does not predict sediment yields into particular sediment basins;^[2]
- (ii) It predicts average annual soil loss and not that for a particular storm event;
- (iii) It is effective for erosion through sheet and rill flow only on short slopes (<300m) and not for concentrated flow or long slopes; and
- (iv) It does not adequately take into account soil dispersibility in assessment of the K-factor.

Despite these matters, the RUSLE has its benefits and should be applied at all urban development sites, even at a cursory level.

A2 Rainfall Erosivity Factor – R

The rainfall erosivity factor, R, is a measure of the ability of rainfall to cause erosion. It is the product of two components: total energy (E) and maximum 30-minute intensity for each storm (I30). So, the total of EI for a year is equal to the R-factor.

Rosewell and Turner (1992) have identified a strong correlation between the R-factor and the 2-year ARI, 6-hour storm event. Data in Appendix B has been based on this phenomenon. It includes a small-scale map of the R-factor for all New South Wales and more detailed information for some coastal locations where contours are very tight. Where Appendix B still does not give sufficient detail, the R-factor can be obtained from Equation 2.

$$R = 164.74(1.1177)^S S^{0.6444} \dots \dots \dots \text{Equation (2)}$$

where S is the 2-year ARI, 6-hour ARI rainfall event (mm) (Rosewell and Turner, 1992).

Isoerodent maps showing lines of equal erosivity were published for Queensland (Rosenthal and White, 1980), Western Australia (McFarlane *et al.* 1986), New South Wales (Rosewell and Turner 1992), South Australia (Yu and Rosewell, 1966b), and Victoria (Sheridan and Rosewell, 2003). In addition, a relationship between the R-factor and 2-year, 6-hour rainfall intensity has been developed for many sites in Australia (Rosewell and Turner 1992, Rosewell 1993a). Such a relationship has been used to estimate rainfall erosivity for all states and territories based on rainfall intensity data published in Pilgrim (1998), Rosewell (1993b and 1997), and Sheridan and Rosewell (2003). High resolution, Australia-wide maps of R-factor are in the Australian Natural Resources Atlas (figure A1).

2. In most situations, not all the sediment entrained on eroding lands is transported away from the site. However, at most construction sites where sediment trapping devices are very close to areas of erosion and the fine particles are flocculated, it can be assumed that most sediment entrained can be trapped.

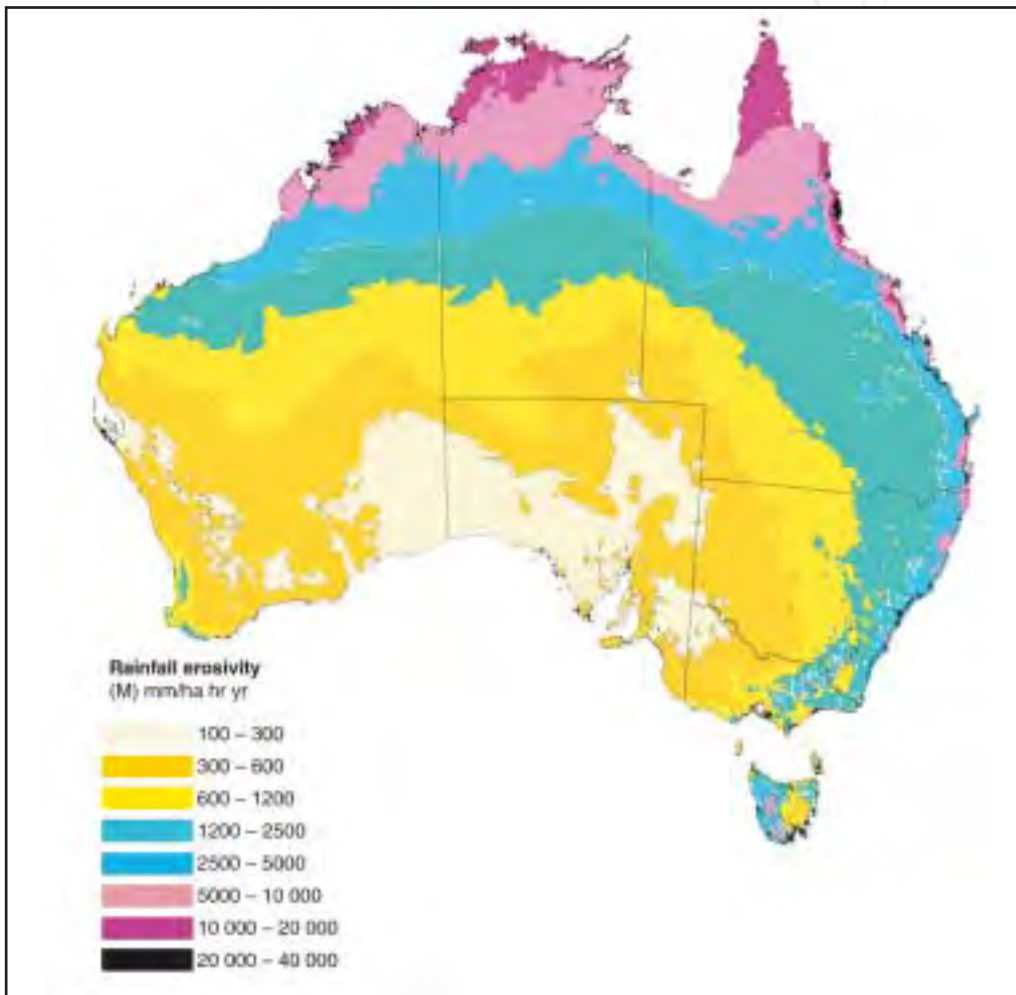


Figure A1 R-factors for Australia (Australian Natural Resources Atlas, 2001)

The quality of the estimated R-factor depends on the quality of the limited pluviograph data. To overcome the problem with limited pluviograph data and to estimate the seasonal distribution of rainfall erosivity, a model using daily rainfall data has been tested for both temperate and tropical regions of Australia (Yu and Rosewell 1996a and 1996b, Yu 1998). Also, regional relationships of model parameters were developed to allow prediction of the R-factor and its monthly distribution from daily rainfall anywhere in Australia (Yu, 1998).

Based on average rainfall data, the high R-factor for Cairns (16,950) is particularly relevant because 77 percent of it occurs in the four-month monsoon season between December and March. Conversely, Adelaide has a very low R-factor (330) with a much more non seasonal rainfall that is very much lower in total.

Where there is any significant seasonality to the R-factor, monthly or fortnightly data should be used to identify those times of the year when lands with very high erosion hazards should:

- either not be developed, or
- have special erosion control measures put in place to compensate.

Fortnightly EI data are available for some locations in New South Wales (Rosewell and Turner, 1992) (Table 7.1) and monthly data in Queensland (Rosenthal and White, 1980). Monthly estimates are available for some locations in South Australia (Yu and Rosewell, 1996b) and Western Australia (McFarlane *et al.*, 1986). A method for estimating half monthly values of erosivity from monthly data is provided by Renard *et al.* (1997).

Noting that data on the R-factor in the RUSLE are derived from average annual rainfall information is important. Consequently, it does not account for seasonality or hydrology, especially antecedent conditions affecting peak flow and total runoff. Other methods are available to help where more detailed data are required (Section A7).

In some areas in eastern Australia, rainfall erosivity does not vary much throughout the year. Such areas usually have quite low R-factors, so erosion hazards are relatively low. However, local rainfall statistics in other areas show marked seasonal trends and some of these have quite high R-factors. In these areas, development and construction works programs should take advantage of the statistical information and encourage works on lands with high erosion hazards to be undertaken in “drier” months. This risk-based approach recognises that unseasonable rainfall events might occur at unexpected times, both from one year to another and seasonally.

Rosewell and Turner (1992) provide data for 29 sites in NSW on the “annual exceedence probability” (AEP) for rainfall erosivity. The annual exceedence probability is the probability of exceedence of a given R-factor in any one year. Figure A2 illustrates the effect of rainfall variation at a site at Richmond, NSW. It shows computed average annual soil loss for different slopes using:

- the R-factor for the site (1,772); and
- the 50 percent, 20 percent and 5 percent AEP for rainfall erosivities (1,397, 2,247 and 3,536, respectively) instead of the R-factor.

The Richmond site has a K-factor of 0.038, a P-factor of 1.3, a C-factor of 1.0 and slope length is 80 metres. Most importantly, the data shows that the calculated average annual soil loss based on:

- the 5 percent AEP rainfall erosivity is higher than data based on the R-factor by 1.99
- the 20 percent AEP is higher by 1.27
- the 50 percent AEP is lower by 0.79.

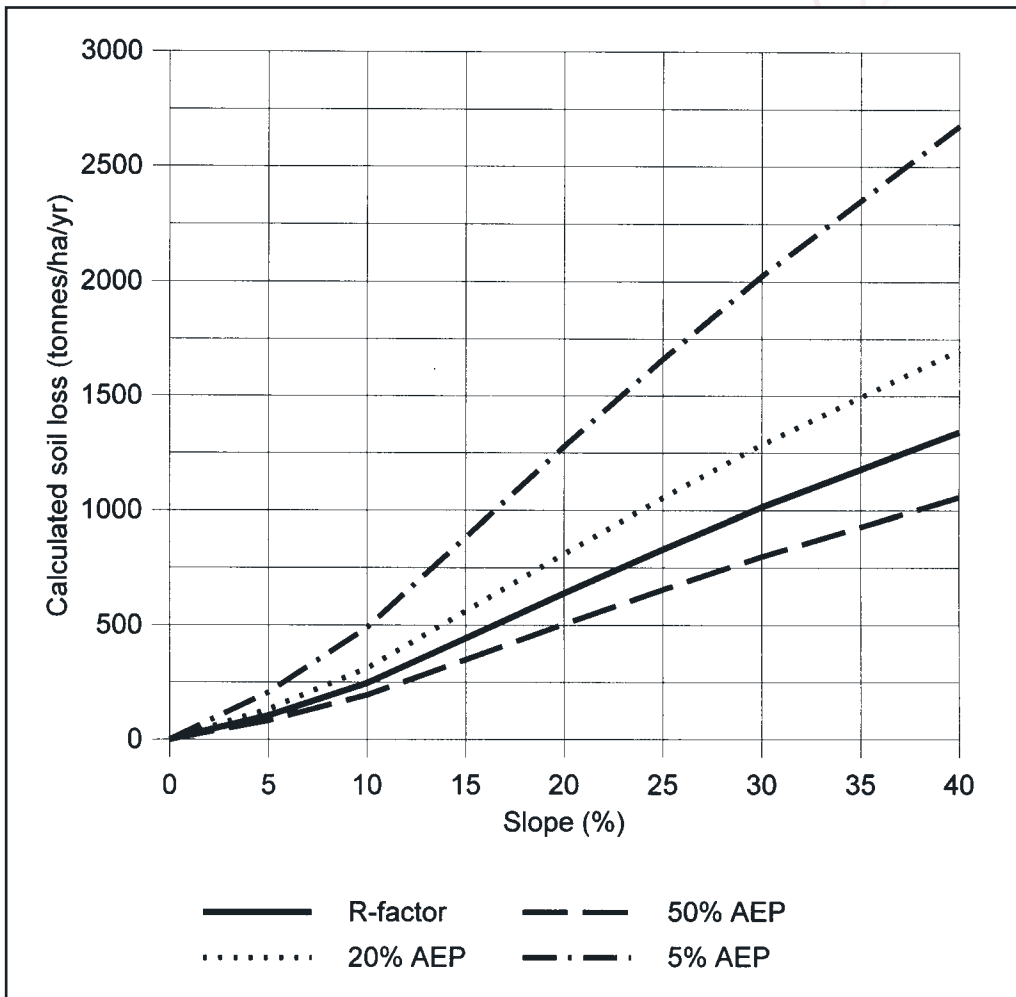


Figure A2 Average annual soil losses calculated for a site near Richmond, NSW, based on the usual R-factor, and the 50 percent, 20 percent and 5 percent AEP

Note that the variations illustrated in Figure A2 are not constant from one location to another. For example, a similar analysis at Port Kembla, NSW, shows the 5 percent AEP higher by 3.28, the 20 percent AEP higher by 1.52 and the 50 percent AEP lower by 0.68.

Also, note that at Richmond, there is a 20 percent probability that a single storm can yield a rainfall erosivity (erosion index) of 1,021 compared with the R-factor (long-term average annual sum of erosion index) of 1,772. Likewise, there is a 10 percent and 5 percent probability that it can yield rainfall erosivities of 1,453 and 2,258 respectively.

A3 Soil Erodibility Factor – K

The soil erodibility factor, K, is a measure of the susceptibility of soil particles to detachment and transport by rainfall and runoff. Soil texture is the principle component affecting K, but soil structure, organic matter and profile permeability also contribute. In the RUSLE, it is a quantitative value experimentally determined.

K should be derived for each particular site and based on laboratory analysis, particularly at sensitive sites. The method for estimating the K-factor is described by Rosewell and Loch (2002). Figure A3 or the SOILOSS program (Rosewell, 1993b) or can help deriving K from raw laboratory data.^[3] Generally, the K-factor ranges from 0.005 (very low) to 0.075 (very high).

When using figure A3, note the following:

- (a) "Texture grading" is described in the following classes – only particles finer than 2 mm are entered here:
 - Coarse sand – 0.2 to 2.0 mm diameter (200 to 2,000 microns)
 - Fine sand – 0.1 to 0.2 mm (100 to 200 microns)
 - Very fine sand – 0.02 to 0.1 mm diameter (20 to 100 microns)
 - Silt – 0.002 to 0.02 mm diameter (2 to 20 microns)
 - Clay – < 0.002 mm diameter (<2 microns).
- (b) "Organic matter" – to convert percentage organic carbon to percent organic matter, multiply by 1.72.
- (c) "Soil structure" is described in the following grades:
 - 1 – very fine granular where particles are mostly less than 1 mm diameter
 - 2 – fine granular where particles are mostly 1 to 2 mm diameter
 - 3 – medium or coarse granular where particles are mostly 2 to 10 mm diameter
 - 4 – blocky, platy or massive.
- (d) "Profile permeability" refers to the rate of infiltration of water (Ksat) into the whole soil profile as follows:
 - 1 – rapid, greater than 130 mm per hour (includes most Soil Hydrologic Group A (Table F2))
 - 2 – moderate to rapid, 60 to 130 mm per hour (includes some Soil Hydrologic Group B and some Group A)
 - 3 – moderate, 20 to 60 mm per hour (includes some Soil Hydrologic Group B)

3. Rosewell (1993b) is an excellent program for estimating the K-factor in Australia. However, the program was developed for use in agricultural situations and should not be used on other lands except to derive the K-factor.

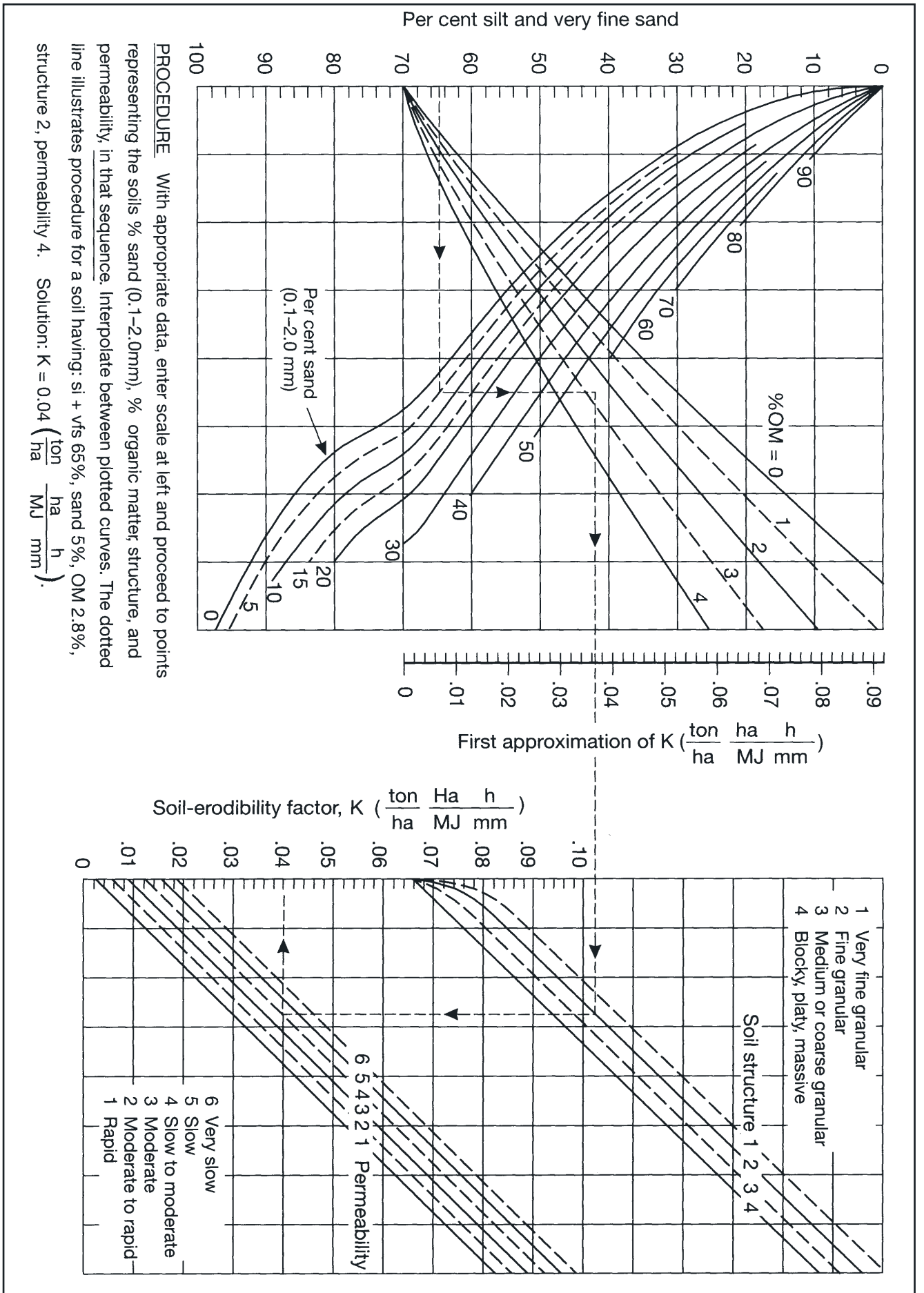


Figure A3 Soil erodibility nomograph in SI units (Foster et al., 1981)

- 4 – slow to moderate, 5 to 20 mm per hour (includes some Soil Hydrologic Group B and some Group C)
- 5 – slow, 1 to 5 mm per hour (includes some Soil Hydrologic Group C)
- 6 – very slow, <1 mm per hour (includes all Soil Hydrologic Group D).

In addition, Rosewell (1993) suggests that:

- (i) Soils where the subsoil structure grade is moderate or strong or where the texture is coarser than silty clay are usually Class 3;
 - (ii) Soils that have moderately permeable topsoils underlain by silty clays or silty clay loams with weak subangular or angular blocky structures are usually Class 4;
 - (iii) Permeable surface soils overlying massive clays or silty clays are usually Class 5; and
 - (iv) All soils with hardpans or other impervious layers near the surface (see figure F1) are usually Class 6.
- (e) "Gravel" describes those particles from 2 to 60 mm diameter. Do not enter data here if the permeability class already includes an allowance for the effect of rock fragments. Rocks on the surface should be treated as surface cover and allowed for in the C-factor.

Probable conservative values for subsoil K-factors of many New South Wales soils are provided at Appendix C. Here, various soil landscape data prepared by the Department of Infrastructure Planning and Natural Resources (DIPNR) are listed. The DIPNR data are derived from 1:100 000 scale mapping and, consequently, might not apply to any particular site especially on highly variable Soil Landscapes, e.g. alluvial units. On highly variable units and/or on sensitive sites and/or where Appendix C does not contain soils information for a site, obtain K from data derived for the local soils and applied to figure A3 or the SOILOSS program.

Arguably, the K-factor is the least accurate component of the RUSLE. It has special weaknesses on soils that are strongly stabilised by iron and on those that are highly dispersible.^[4] The problem of strongly stabilised soils can be addressed by ensuring that a chemical dispersion agent (e.g. Calgon) is not used before particle size analysis, i.e. dispersion is achieved only through mechanical means. However, there is very little data to show the effect of soil dispersion on the K-factor. Nevertheless, it is suggested that the K-factor be increased by 20 percent for all Emerson Aggregate Class 1 and 2 soils. No further advice can be given at this time.^[5]

4. Usually, soils that are strongly stabilised by iron are red and well aggregated (e.g. Krasnozems). Some of their clay fraction exists as very small aggregates in the silt and fine sand-size range, the most erodible size. Dispersible soils usually have high levels of exchangeable sodium on the clay fraction, and low levels of soluble salts in the soil (see Section 6.3.3 and Appendix E).

5. Research by Singer *et al.*, (1982) suggests that K-factor values determined using the methods outlined here should be increased by 20 percent where the exchangeable sodium percentage exceeds 2.

A4 Slope Length/Gradient Factor – LS

The slope length–gradient factor, LS, describes the combined effect of slope length and slope gradient on soil loss. It is the ratio of soil loss per unit area at any particular site to the corresponding loss from a specific experimental plot of known length and gradient. Take typical upper values for slope length (metres) and gradient (percent) for the site in question and apply them to Table A1.

In the RUSLE, different LS-factors apply to low, moderate and high ratios of rill to interrill erosion:

- low ratio applies to undisturbed grazing/pasture lands with good cover (e.g. many construction sites before works start) – Option 1
- moderate applies to moderately consolidated crop lands with little to moderate cover (the default used in SOILOSS) – Option 2
- high applies to highly disturbed lands with little or no cover (e.g. most operational construction sites) – Option 3.

No experimental data exist to support the LS-factor for undisturbed soils (Option 1) on slopes steeper than 60 percent. Further, only limited data are available for disturbed soils (Option 3) on slopes of less than 5 metres length and steeper than 84 percent. Because SOILOSS defaults to Option 2 and construction sites should be using Option 3, any LS data from SOILOSS should be adjusted according to Table A1. Note that, generally, LS should be kept below 10.00 on construction sites.

Table A1 LS-factors on construction sites using the RUSLE

Slope ratio	Slope gradient (%)	Slope length (m)															
		5	10	20	30	40	50	60	70	80	90	100	150	200	250	300	
100:1	1	0.09	0.11	0.13	0.15	0.16	0.17	0.18	0.19	0.19	0.20	0.20	0.23	0.24	0.26	0.27	
50:1	2	0.14	0.18	0.24	0.28	0.31	0.34	0.36	0.39	0.41	0.43	0.44	0.52	0.58	0.64	0.69	
33.3:1	3	0.17	0.24	0.34	0.41	0.47	0.52	0.57	0.61	0.65	0.69	0.72	0.87	1.00	1.11	1.22	
25:1	4	0.21	0.30	0.44	0.54	0.63	0.71	0.78	0.85	0.91	0.97	1.03	1.26	1.47	1.65	1.82	
20:1	5	0.24	0.36	0.54	0.68	0.80	0.91	1.01	1.10	1.19	1.27	1.35	1.70	2.00	2.28	2.53	
16.6:1	6	0.28	0.42	0.64	0.81	0.97	1.11	1.24	1.36	1.47	1.58	1.68	2.14	2.54	2.91	3.25	
12.5:1	8	0.34	0.53	0.83	1.08	1.31	1.51	1.70	1.88	2.05	2.21	2.37	3.07	3.70	4.28	4.82	
10:1	10	0.42	0.68	1.09	1.44	1.75	2.04	2.31	2.56	2.81	3.04	3.27	4.06	4.94	5.75	6.52	
8.3:1	12	0.52	0.85	1.39	1.85	2.27	2.66	3.02	3.37	3.70	4.02	4.33	5.77	7.07	8.28	9.42	
7.1:1	14	0.62	1.02	1.69	2.26	2.79	3.28	3.74	4.18	4.61	5.02	5.42	7.27	8.95	10.52	12.01	
6.3:1	16	0.71	1.19	1.98	2.67	3.31	3.90	4.46	5.00	5.52	6.02	6.51	8.78	10.86	12.81	14.65	
5.5:1	18	0.80	1.35	2.27	3.07	3.82	4.51	5.17	5.81	6.42	7.02	7.59	10.30	12.78			
5:1	20	0.89	1.50	2.55	3.47	4.32	5.12	5.88	6.61	7.32	8.01	8.68	11.92	14.84			
4:1	25	1.09	1.88	3.23	4.43	5.54	6.59	7.60	8.57	9.51	10.43	11.32					
3.3:1	30	1.28	2.23	3.86	5.32	6.69	7.99	9.23	10.43	11.60	12.74	13.85					
2.5:1	40	1.61	2.83	4.98	6.92	8.74	10.48	12.15	13.77								
2:1	50	1.88	3.33	5.89	8.22	10.42	12.52	14.55									

Table A1 assumes that on Soil Loss Classes 3, 4, 5, 6 or 7 lands where more than 1,000 square metres of land are to be disturbed, slope lengths do not exceed 80 metres immediately before forecast rainfall or during shutdown periods (Section 4.3.1). Longer slopes might be acceptable where the calculated average annual soil loss from the total area of land disturbance is maintained at low levels (e.g. <150 cubic metres per year).

A5 Erosion Control Practice Factor – P

The erosion control practice factor, P, is the ratio of soil loss with a nominated surface condition ploughed up and down the slope. It is reduced by practices that reduce both the velocity of runoff and the tendency of runoff to flow directly downhill. At construction sites, it reflects the roughening or smoothing of the soil surface by machinery (figure A4).

Table A2 suggests appropriate values for P for construction sites. While changing the surface condition does not greatly affect P, roughening of the surface greatly increases the chances of establishment of a vegetative cover that does substantially reduce soil loss.



Figure A4 Smooth and compact ground surface typical of an urban construction site, raising the P-factor as high as 1.3

Table A2 P-factors for construction sites (Goldman et al., 1986)

Surface condition	P-factor
Compacted and smooth	1.3
Track-walked along the contour ^[6]	1.2
Track-walked up and down the slope ^[7]	0.9
Punched straw ^[8]	0.9
Loose to 0.3 metres depth	0.8

A6 Cover Factor – C

The cover factor, C , is the ratio of soil loss from land under specified crop or mulch conditions to the corresponding loss from continuously tilled, bare soil. The C -factor is different from the runoff coefficient used in hydrologic calculations.

The most effective method of reducing the C -factor is maintenance, or formation of a good ground cover such as outlined in Chapter 7. The best practices (Table A3, figure A5) are those that reduce both the soil exposed to raindrop impact and the erosive effects of runoff. Figure A6 shows the effect of different land uses on calculated average annual soil loss where the R -factor is 2,500, the K -factor is 0.035, the gradient is 10 percent and the slope length is 100 metres. The P and C -factors were:

- the defaults used in the SOILOSS program (Rosewell, 1993) for cultivation, forest and pasture
- those presented here at Sections A5 and A6 for a construction site.

Note that the C -factor provides gross information only. It does not give a true indication as to the fraction retained. Table A4 provides data on this matter based on University of Washington research. The table assumes proper installation and maintenance of the practice.

6. Track marks are orientated normal to the contours.

7. Track marks orientated parallel to the contour.

8. Straw mulch has been punched into a loose ground surface with a disc harrow.

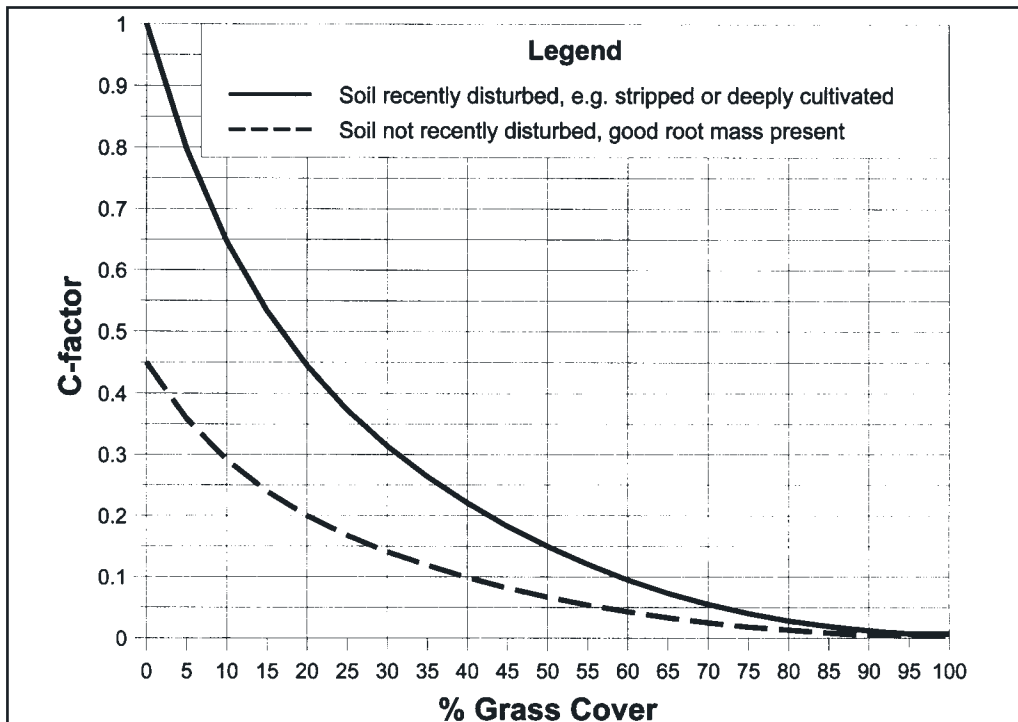


Figure A5 C-factors for established grass cover

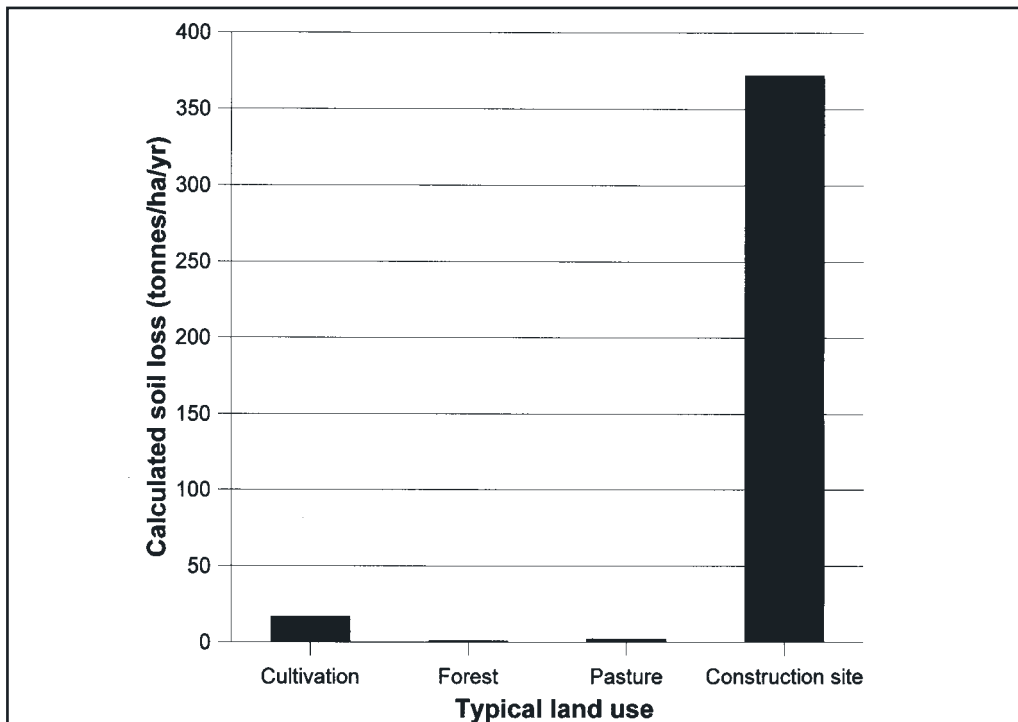


Figure A6 Calculated annual soil losses for different land uses

Table A3 Soil Stabilisation Control Matrix (adapted from various sources, including Meyer and Ports (1976), Israelson et al. (1980), Goldman et al. (1986), URS Greiner Woodward Clyde (1999) and the North American Green website).

Class	Type	Suitable for Vegetation Type ^[1]	Design Life (months)	Use in Concentrated Flow ^[2]	Availability (days) ^[3]	Relative Cost Bracket ^[4]	Residual Impact ^[5]	C-factor ^[6] <33%, <6m	C-factor <33%, 6-15m	C-factor <33%, >15m	C-factor 33-50%, <6m	C-factor 33-50%, 6-15m	C-factor 33-50%, >15m	Notes
BIODEGRADABLE MULCHES ^[7]														
Straw (anchored)	4.5 tonnes per hectare	Grass	1 to 6	No	< 5days	Low	Moderate	0.17	0.17	0.20	0.20	0.20	0.20	<p>1 Whether vegetation is required and its type if so, will affect the technique used. Biodegradable mulches, RECPs and hydraulic soil stabilisers can all be used on their own to provide short term protection. However, their effectiveness is less when used in isolation than when used with vegetative growth. Most techniques are used to help establish vegetative growth using sown grasses. Should the client specify shrubs (primarily planted as tubestocks), then thicker mulches, RECPs or biodegradable mulches should be used. Non biodegradable RECP's are used to reinforce grasses (turf) permanently. They are not suitable for use with individual shrubs. They can work synergistically with the established grass to increase its resistance to shear stress and, therefore, increase its resistance to erosion by concentrated flow.</p> <p>2 Products might or might not be suitable for use in areas of concentrated flow. All products are suitable for sheet flow conditions, although some would be over designed in such cases.</p> <p>3 Whether or not a product is readily available is critical to the selection process. Many RECP and hydraulic soil stabiliser techniques use products that might be "off the shelf" and available from several suppliers. Biodegradable mulches can be affected by seasonal variation, although they might also be available on site after initial clearing and grubbing. Temporary seeding might also be seasonal.</p>
Wood Chip	16 tonnes per hectare	Grass/Shrubs	1 to 6	No	< 5days	Low	Moderate	0.08	0.08	0.08	No data			
Wood Chip	27 tonnes per hectare	Shrubs	1 to 6	No	< 5days	Low	Moderate	0.05	0.05	0.05	No data			
Wood Chip	56 tonnes per hectare	Shrubs	1 to 6	No	< 5days	Low	Moderate	0.02	0.02	0.02	0.02	0.02	0.02	
Hydromulching	1.5 tonnes mulch + 300 litres binder per hectare	Grass	1 to 3	No	< 5days	Low	Low	0.00	0.03	0.07	0.03	0.06	0.10	
Bonded Fibre	5 tonnes fibre per hectare	Grass	1 to 6	No	< 5days	Low	Moderate	0.00	0.03	0.07	0.03	0.06	0.10	
ROLLED EROSION CONTROL PRODUCTS (RECPs) ^[7]														
Biodegradable	Jute mesh	Grass	6 to 12	Yes	< 5days	Low	Moderate	0.10	0.20	0.40	0.20	0.40	0.60	<p>4 For any given technique, cost can vary greatly depending on geographic location, size of project and installation requirements. In addition, costs can vary over time. Because of these factors, giving accurate installed costs is not possible. However, if a product is relatively inexpensive to purchase and install close to its point of manufacture, it will still be relatively inexpensive to purchase and install remote from it.</p> <p>5 This criterion relates to the impact that a particular practice might have on construction activities once they are resumed on an area that was temporarily stabilised.</p> <p>6 The performance of an erosion control technique is quantified by assigning it with a C-factor (Appendix A). The C-factor will vary from close to zero for full cover, to 1.0 for no cover on highly disturbed soils. The C-factor strongly affects the soil loss calculation (RUSLE) and users need to be careful in specifying its value, particularly when values <0.01 are quoted. Note that the C-factor does not apply to concentrated flow.</p>
	Coconut fibre mesh	Grass	6 to 12	Yes	< 5days	Low	Moderate	0.10	0.20	0.40	0.20	0.40	0.60	
	Curled wood fibre	Grass	6 to 12	Yes	< 5days	Medium	Moderate	0.01	0.05	0.10	0.10	0.15	0.20	
	Jute matting (~350 gsm)	Grass	6 to 12	Yes	< 5days	Medium	Moderate	0.00	0.03	0.07	0.03	0.06	0.10	
	Jute matting (~600 gsm)	Shrubs	6 to 12	Yes	< 5days	Medium	Moderate	0.00	0.03	0.07	0.03	0.06	0.10	
	Coconut fibre matting (~450 gsm)	Grass	6 to 12	Yes	< 5days	Medium	Moderate	0.00	0.03	0.07	0.03	0.06	0.10	
	Coconut fibre matting (~900 gsm)	Shrubs	6 to 12	Yes	< 5days	Medium	Moderate	0.00	0.03	0.07	0.03	0.06	0.10	
Photodegradable	Mesh (< 5 mm openings)	Grass	1 to 6	Yes	< 5days	Low	Moderate	0.01	0.05	0.10	0.10	0.15	0.20	
	Non Biodegradable	Plastic fibres with netting	Grass	> 12	Yes	< 5days	High	High	0.00	0.05	0.10	0.03	0.05	0.10
	Composite with biodegradable	Grass/Shrubs	> 12	Yes	< 5days	High	High	0.00	0.03	0.07	0.03	0.06	0.10	
HYDRAULIC SOIL STABILISERS ^[7]														
	Polymers/Polyacrylamide (rate depends on type)	Grass	1 to 6	No	< 5days	Low	Low	0.01	0.05	0.10	0.10	No data		
	Bitumen emulsion (12,000 l/ha)	Grass	1 to 6	No	< 5days	Low	Low	0.01	0.05	0.10	0.10	No data		
TEMPORARY SEEDING														
	Annual	NA	6 to 12	No	< 5days	Low	Low	0.05	0.05	0.10	0.10	No data		
	Perennial	NA	> 12	No	< 5days	Low	Low to moderate	0.05	0.05	0.10	0.10	No data		
INSTANT TURF ^[7]														
	Kikuyu	Grass	> 12	Yes	< 5days	Medium	Low	<0.01	<0.01	<0.01	<0.01	<0.01	<0.01	<p>7 For information on trade names and suppliers of these products, please phone the office of Australasian Chapter of the International Erosion Control Association on 1800 354 322 or (+61 2) 4677 0901.</p>
	Reinforced turf (pregrown)	Grass	> 12	Yes	5 - 15 days	High	High	<0.01	<0.01	<0.01	<0.01	<0.01	<0.01	

Practice	C-factor	Turbidity factor	Loss factor for phosphorus
Open-weave jute mesh	0.4	0.97	0.7
Wood fibre mulch	0.01	0.04	0.4
Straw mulch	0.06	0.2	0.2
Woven straw blanket	0.08	0.2	0.13

Table A4 Factors for practices tested in University of Washington research

A7 Sediment Yields

A7.1 Sediment Delivery Ratio

The ratio of sediment yield at a given location to the sediment entrained in the erosion process is the sediment delivery ratio. The RUSLE can calculate the sediment entrained in the erosion process. Other factors influencing the sediment delivery ratio include:

- the drainage area
- the topography and channel density
- the relief and length of the watershed
- the presence of natural or built sediment traps
- rainfall characteristics
- coefficient of runoff.

Once a value has been determined for the sediment delivery ratio, sediment yield can be determined.

A7.2 The Modified USLE (MUSLE)

The Modified USLE (MUSLE) eliminates the need for a sediment delivery ratio in many situations. It is based on work by Williams (1975), who replaced the R-factor in the USLE with a term for runoff intensity to eliminate the need for a delivery ratio. This modified USLE (MUSLE) is shown in Equation 3.

$$S_y = a (V Q_p)^b K LS C P \dots \dots \dots \text{Equation (3)}$$

where: S_y is the sediment yield in tonnes

a and b are coefficients

V is the volume of runoff for the event in cubic metres

Q_p is the peak runoff rate for the event in cubic metres per second

K , LS , P and C are normal USLE factors.

The equation is identical to the USLE except that:

- S_y is sediment yield instead of soil loss
- $(VQp)^b$ is a runoff factor for sediment transport instead of the USLE rainfall erosivity factor R .

Studies in the USA, mainly for rainfall events, have produced coefficients of $a = 89.6$ and $b = 0.56$. Some references show the value of $a = 11.8$, which is for K in metric units rather than the SI units quoted here. A comparison on agricultural soils in southern Queensland (Freebairn *et al.*, 1989) shows that MUSLE explained better than 80 percent of the variance in the measured sediment yield.

A7.3 Water Erosion Prediction Project (WEPP)

The Water Erosion Prediction Project (WEPP) has been a major program of several US agencies to develop soil erosion prediction technology that will advance, and possibly replace the USLE in a few years. It is a physically based model, based on algorithms that simulate physical processes such as infiltration, detachment, sediment transport, etc. This contrasts with the USLE, which is based largely on empirical relationships.

The WEPP model operates by running a continuous simulation of most of the components of the water cycle on a daily time step. It contains components that model hydrology, plant growth and residue production, and erosion.

WEPP predicts runoff volume from a rainfall event using a water balance submodel. Depending on soil and cover conditions, this runoff may entrain soil particles. It determines:

- the total runoff volume
- average and maximum sediment yields (annual or storm-based)
- whether erosion is by rill and/or interrill erosion processes
- where eroded sediment might be deposited
- the particle size composition of the eroded sediment
- whether further sediment might be entrained.

Unfortunately, WEPP requires a large data input, much more than the USLE. Evaluation of WEPP at Gunnedah, New South Wales, (Yu and Rosewell, 2001) shows that it has a good potential to provide a quantitative basis for further development of erosion hazard.

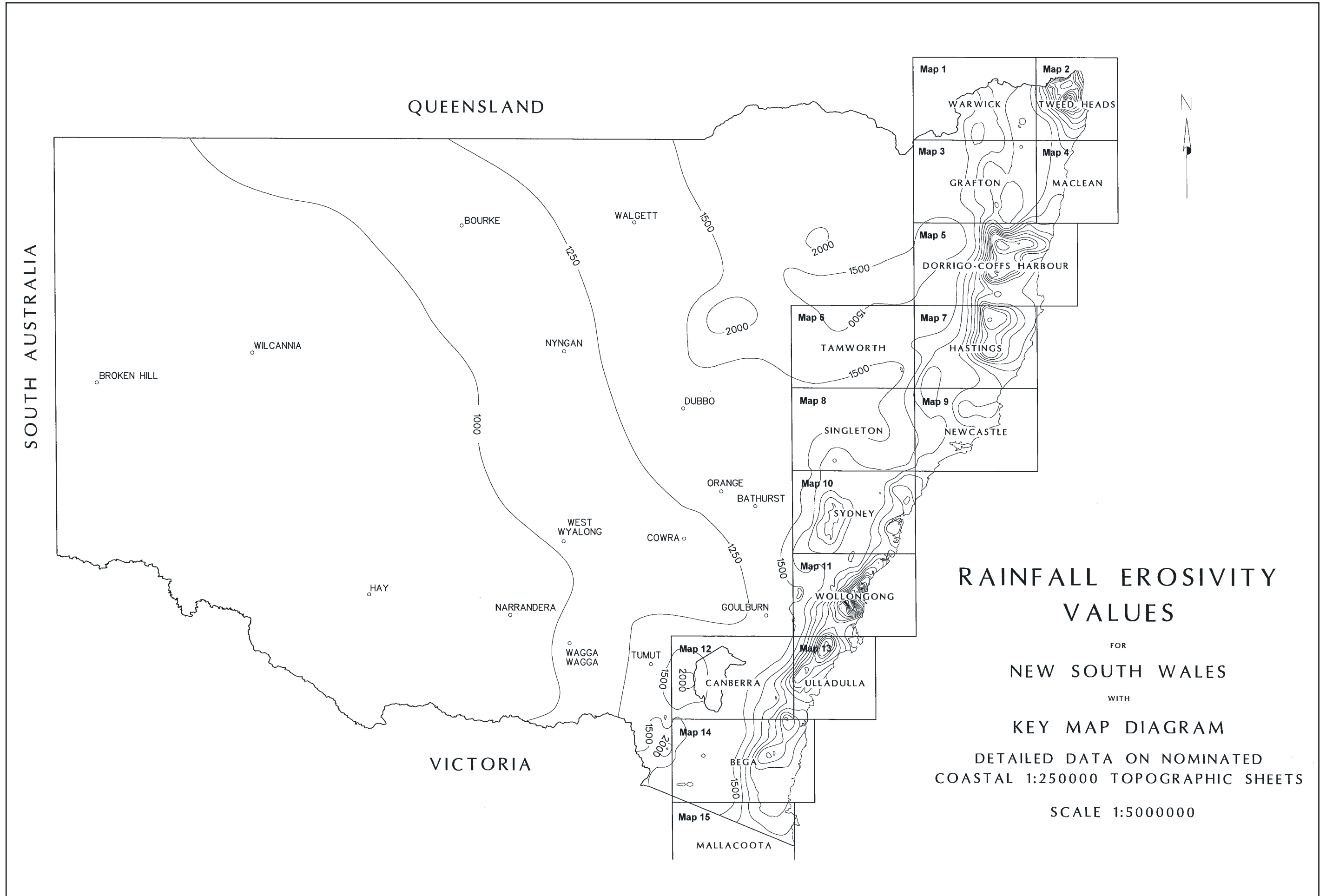


APPENDIX B

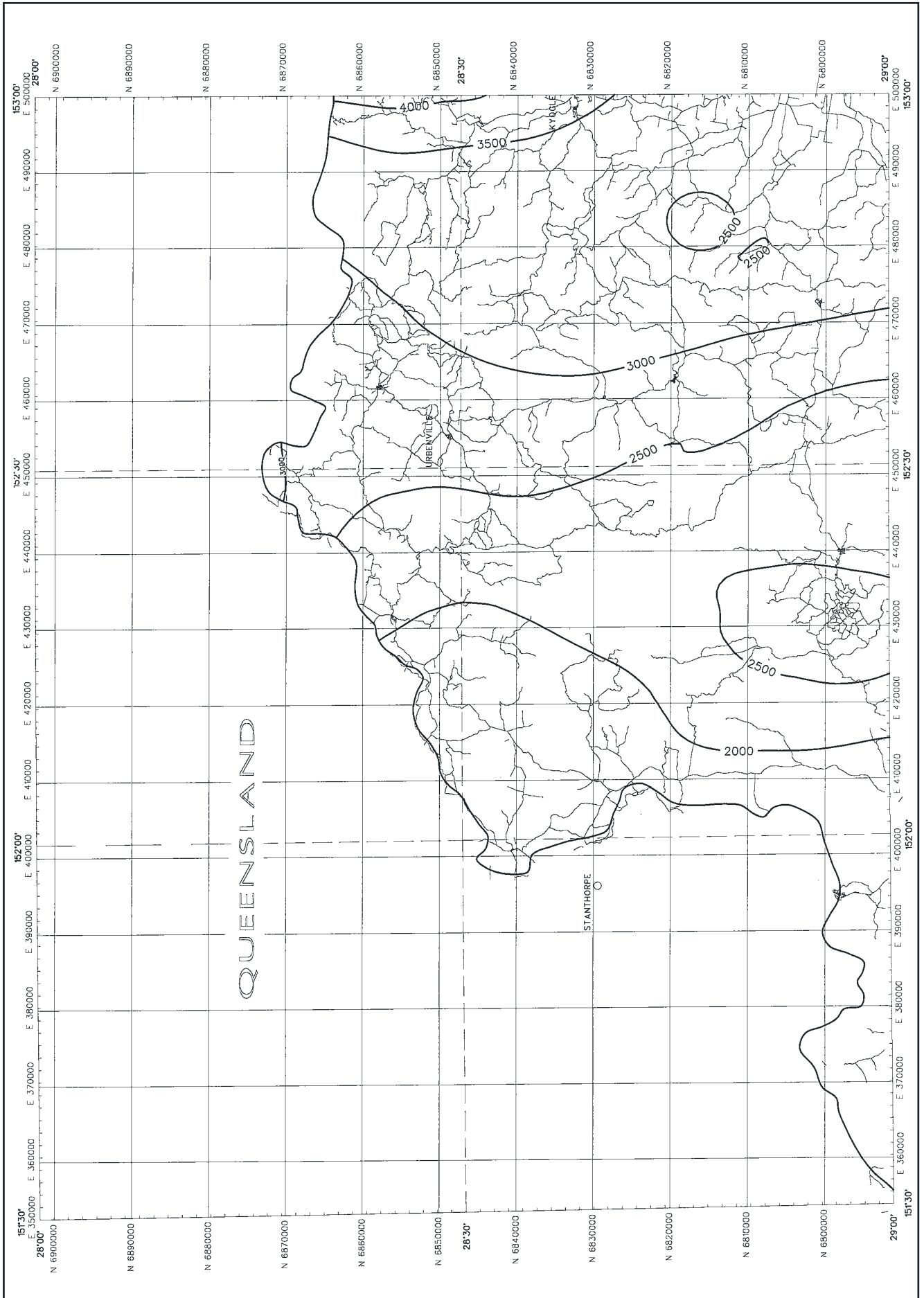
B R-factor Maps

Information relating to the R-factor is taken from data supplied by the Department of Land and Water Conservation, but under agreement with the copyright owners, The Institution of Engineers, Australia and the Australian Bureau of Meteorology. The data were captured at scale 1:1,000,000, so positional accuracy cannot be guaranteed at larger scales. In coastal areas, maps have been prepared to coincide with existing 1:250,000 topographic sheets published by National Mapping. For areas outside New South Wales, refer to figure A1 in Appendix A.

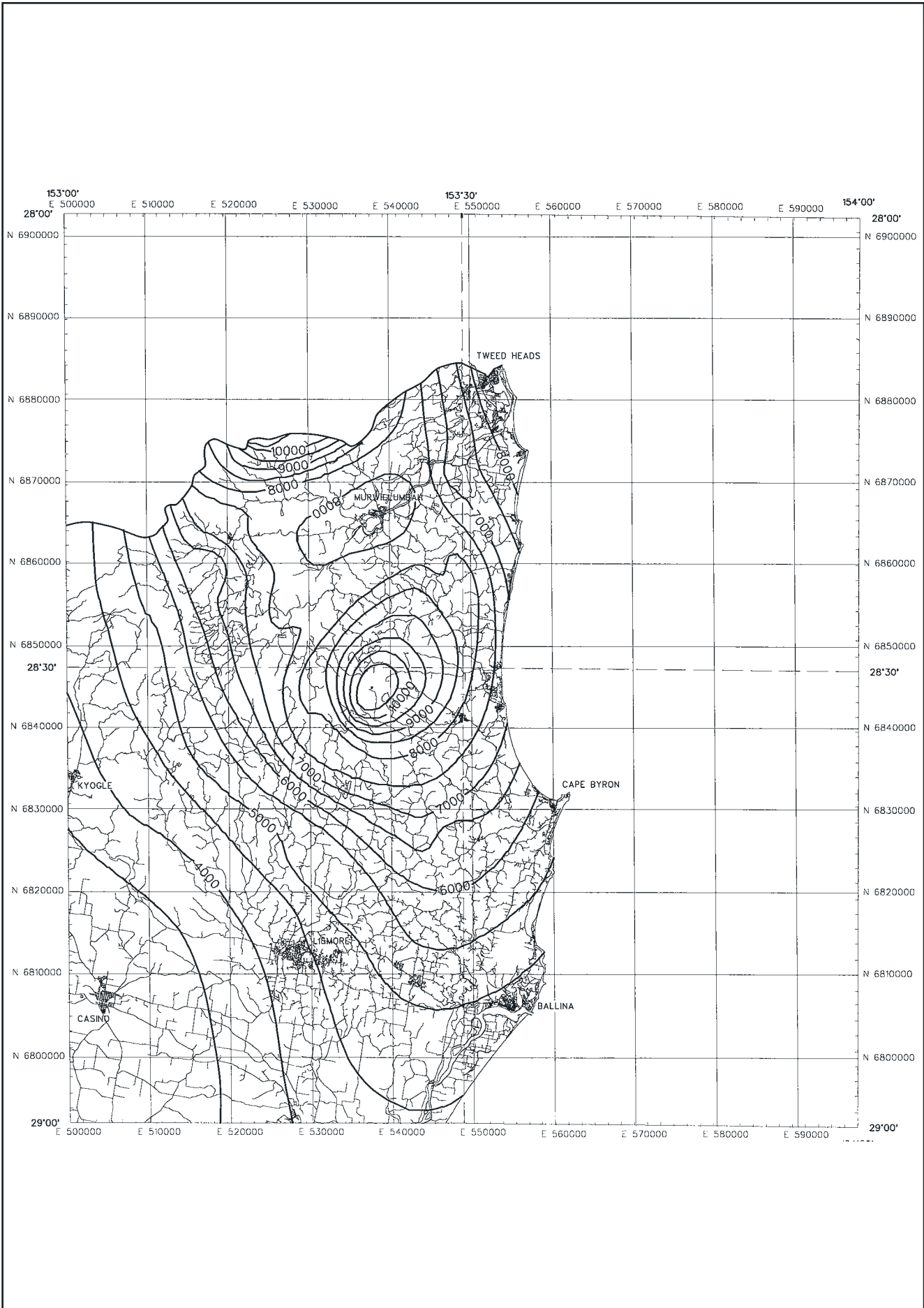
Base mapping was provided by NSW Department of Housing and adapted to the standard 1:250,000 map sheet areas. Map produced on Universal Transverse Mercator Projection with Geographical and Australian Map Grid coordinate reference systems. All mapping is subject to copyright.



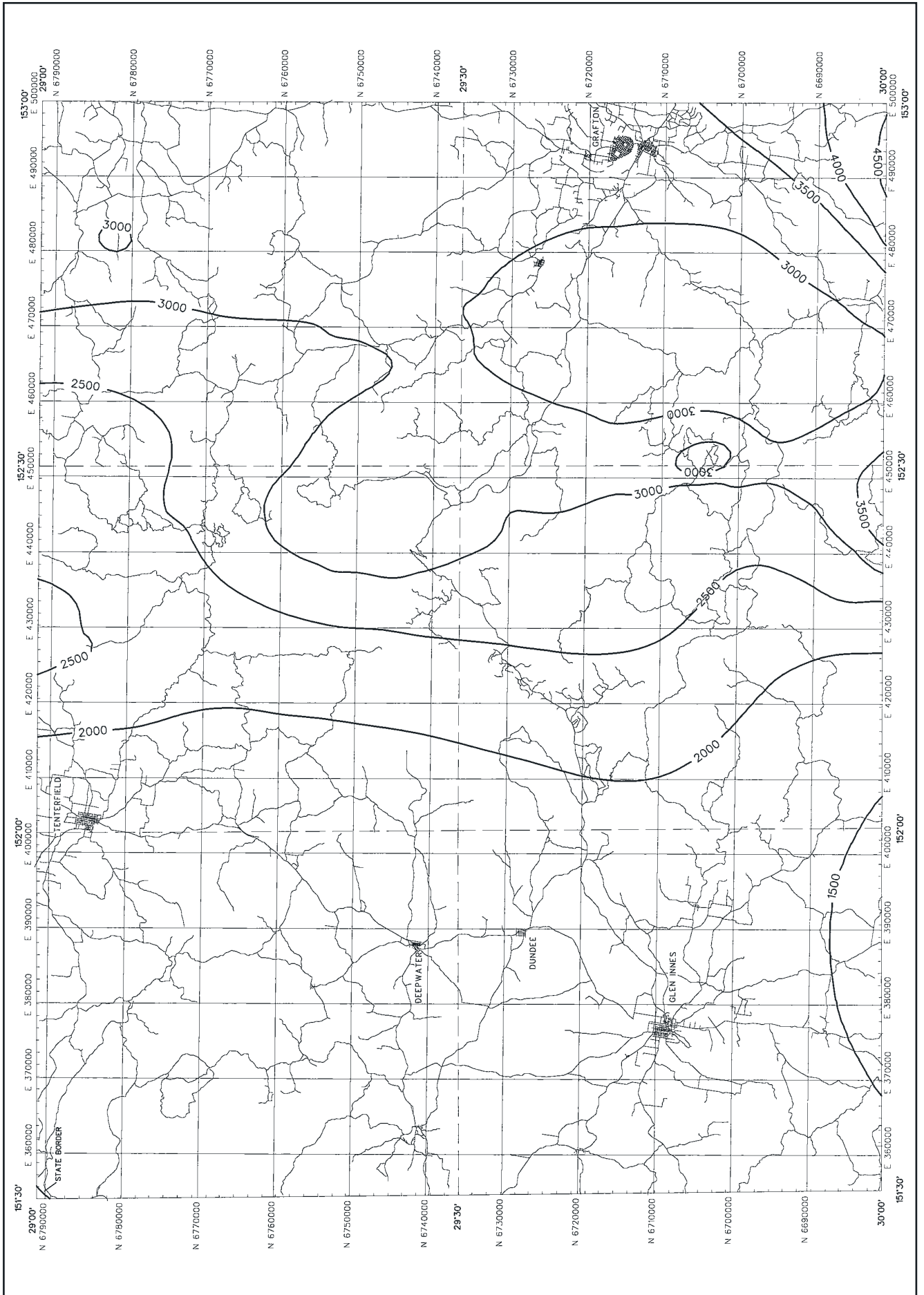
**RAINFALL EROSIVITY
VALUES**
 FOR
NEW SOUTH WALES
 WITH
KEY MAP DIAGRAM
 DETAILED DATA ON NOMINATED
 COASTAL 1:250000 TOPOGRAPHIC SHEETS
 SCALE 1:5000000



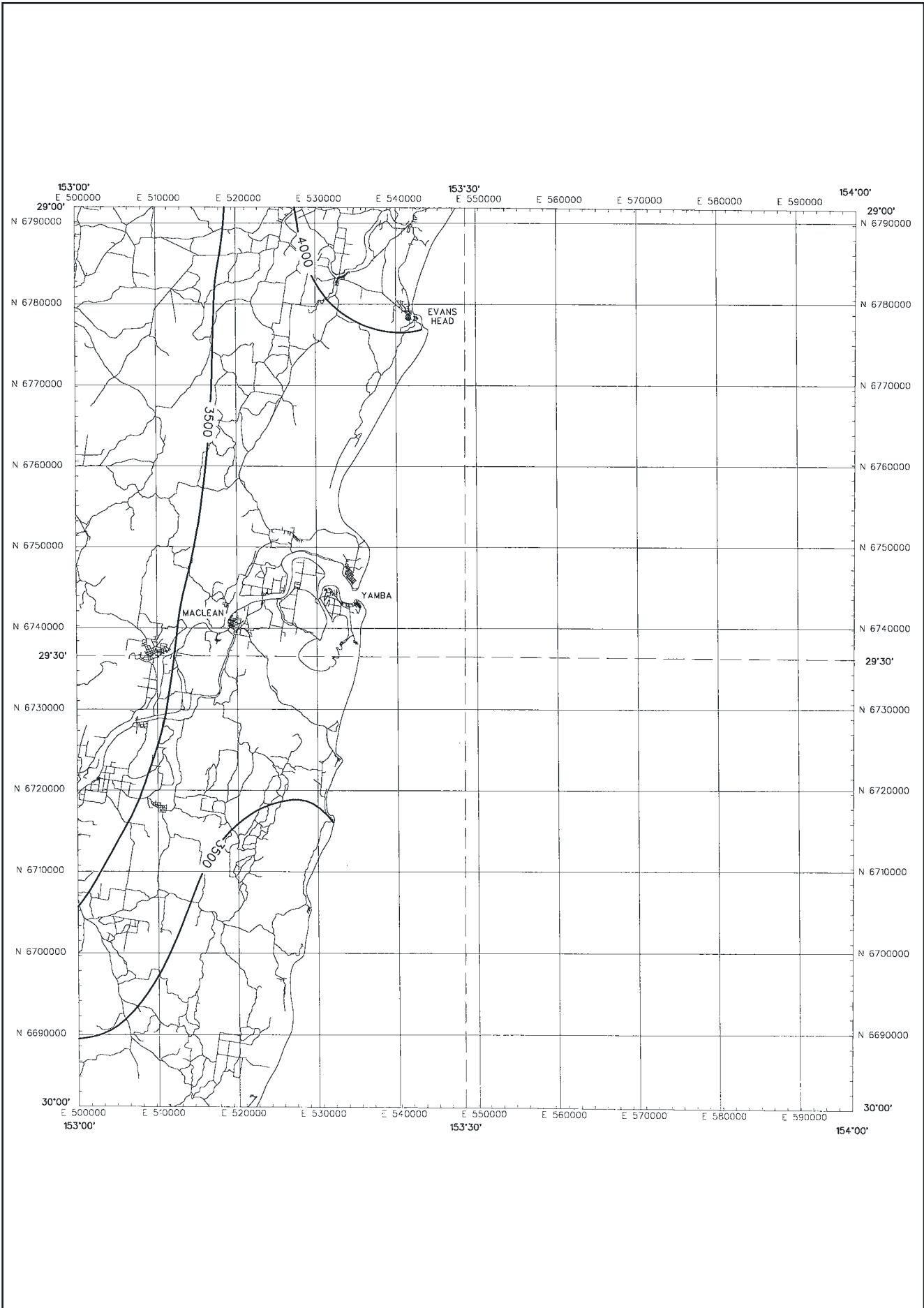
Map 1: Rainfall Erosivity of the Warwick 1:250,000 topographic Sheet



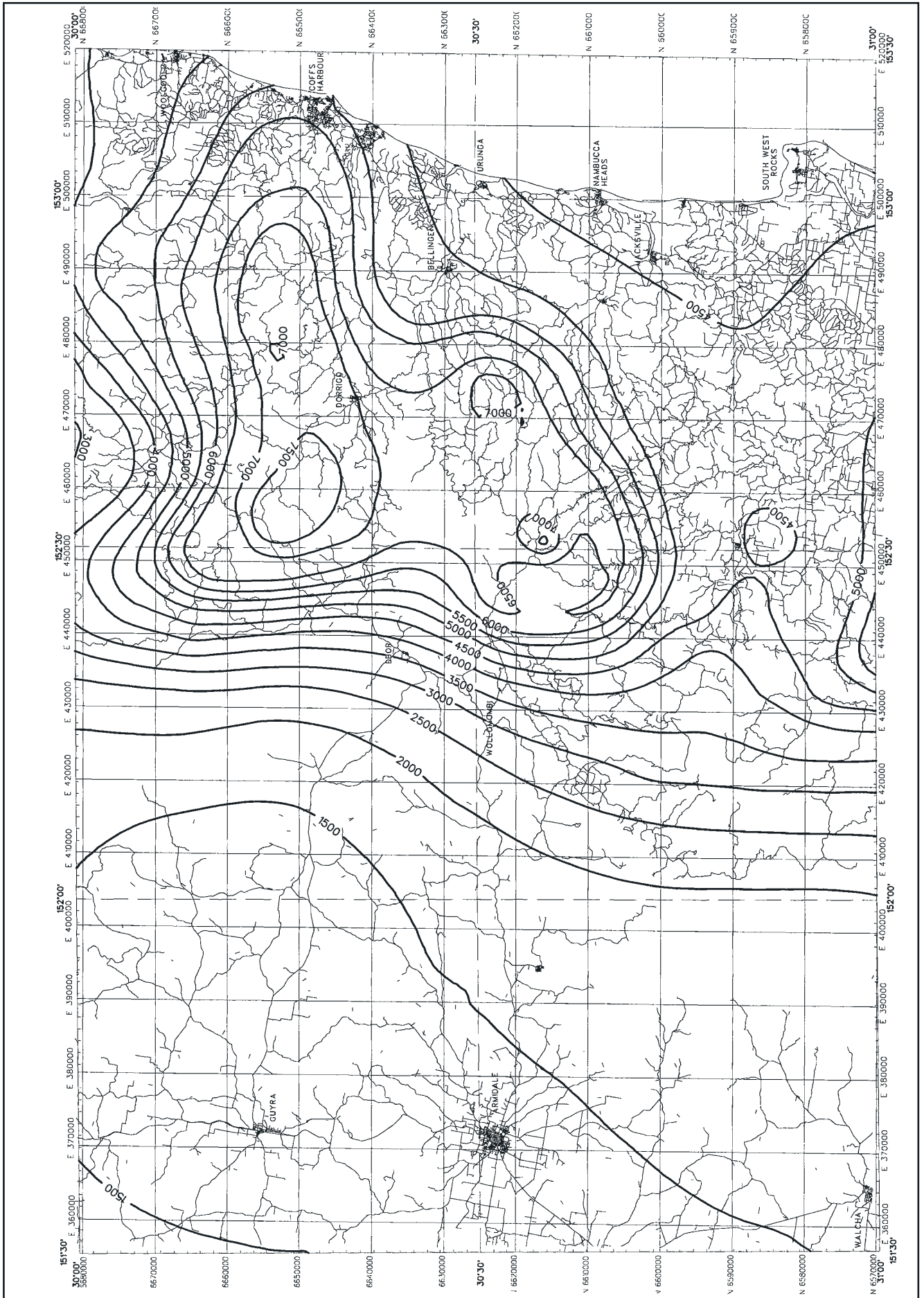
Map 2: Rainfall Erosivity of the Tweed Heads 1:250,000 topographic Sheet



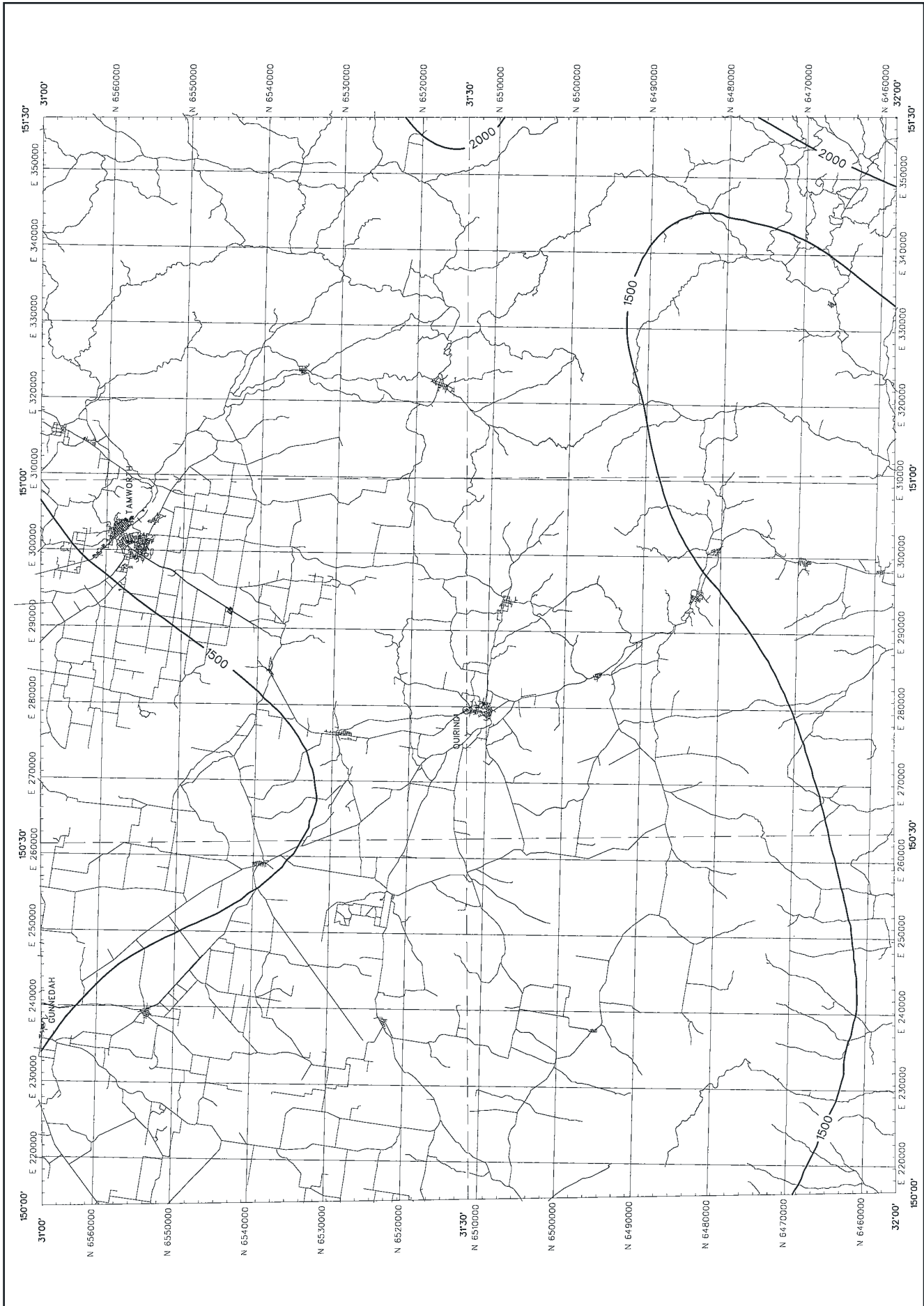
Map 3: Rainfall Erosivity of the Grafton 1:250,000 topographic Sheet



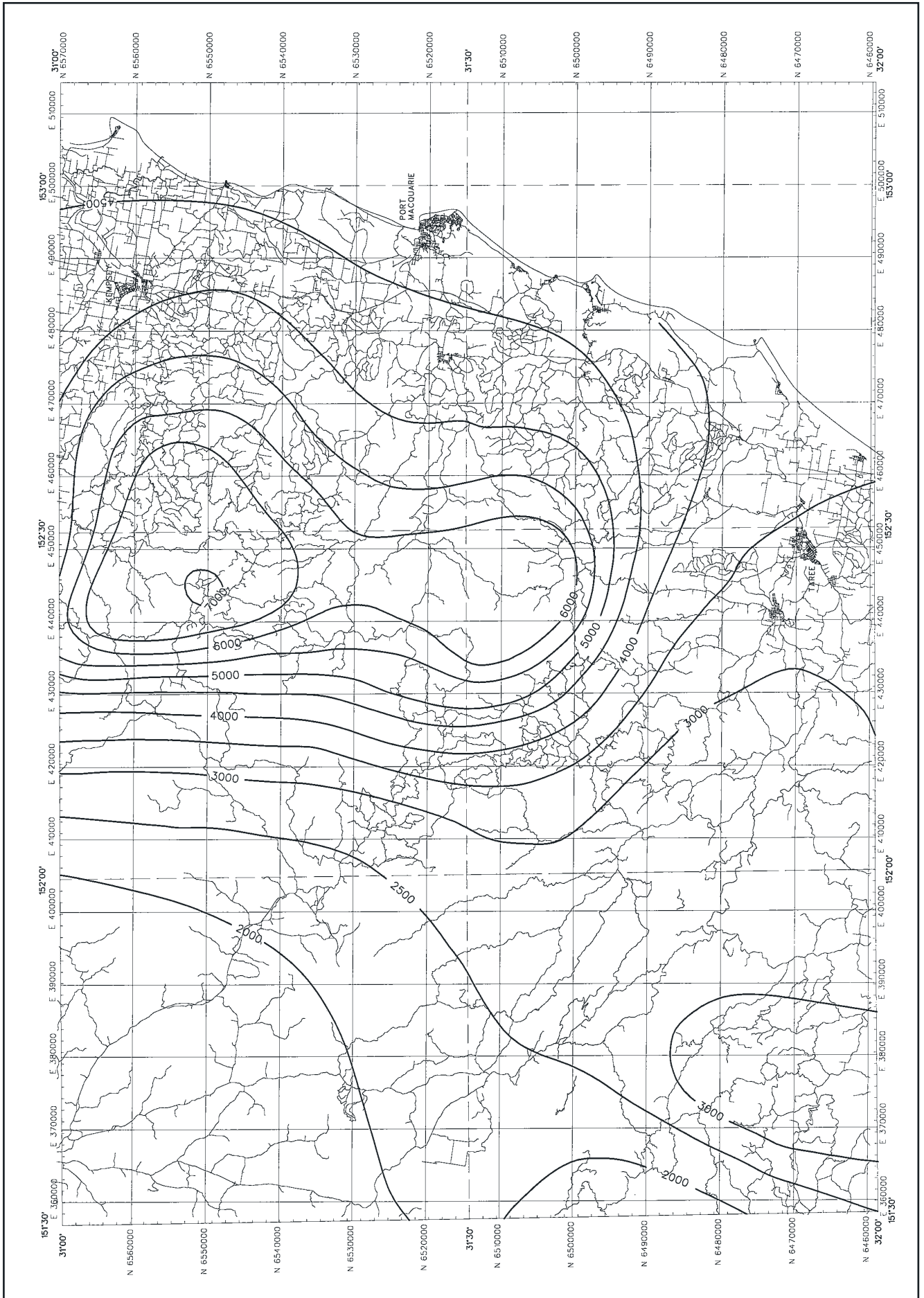
Map 4: Rainfall Erosivity of the Maclean 1:250,000 topographic Sheet



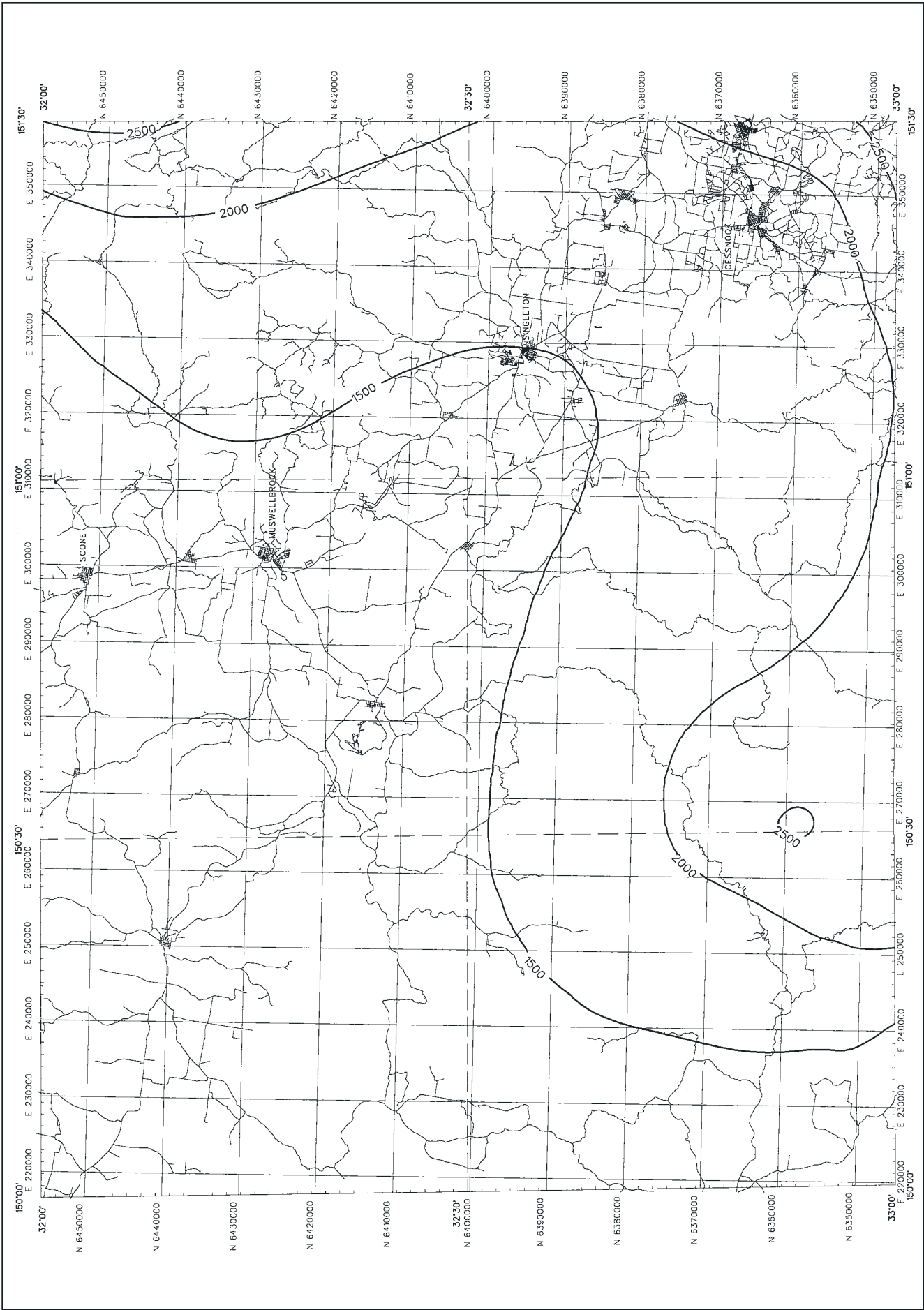
Map 5: Rainfall Erosivity of the Dorrigo 1:250,000 topographic Sheet



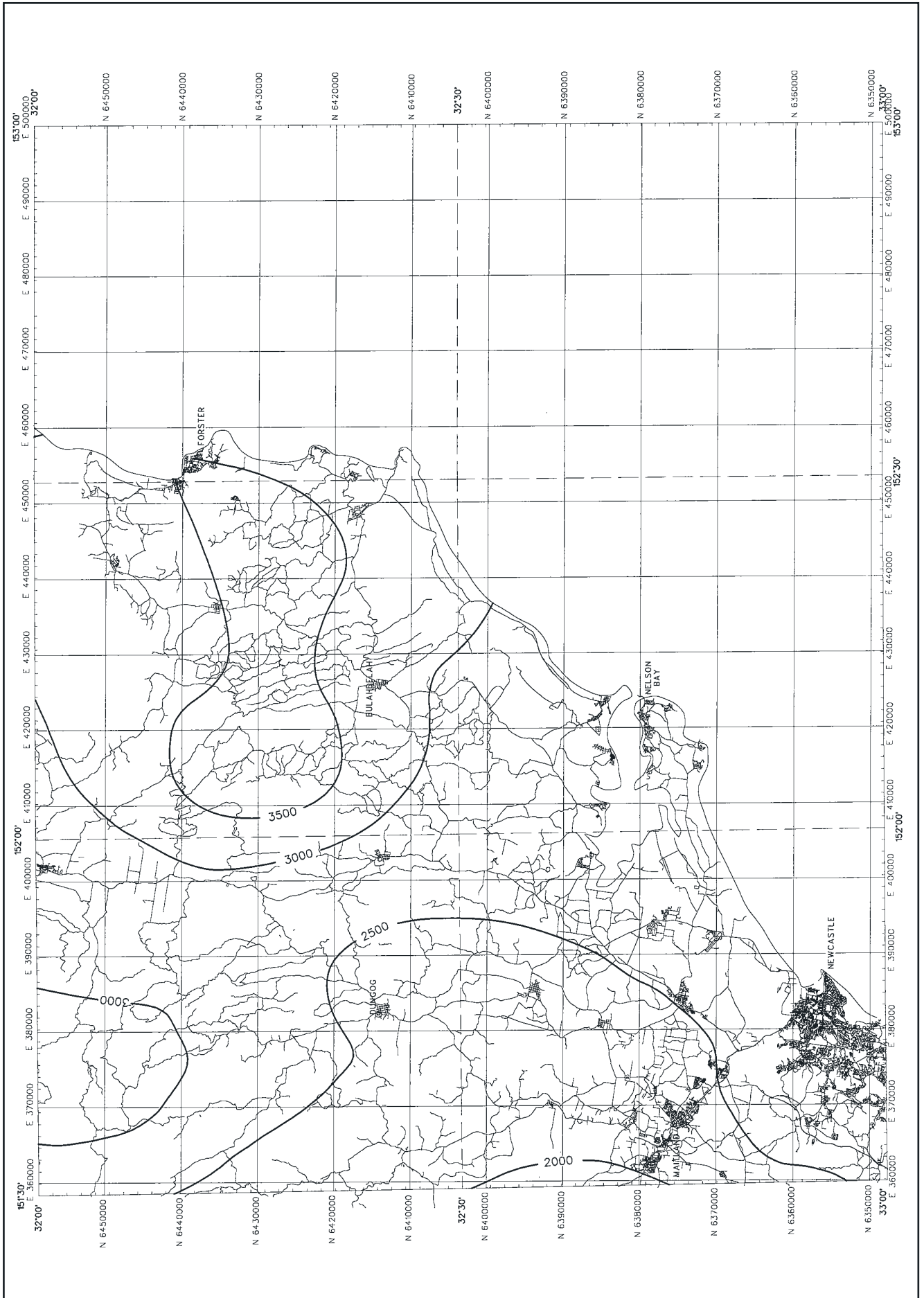
Map 6: Rainfall Erosivity of the Tamworth 1:250,000 topographic Sheet



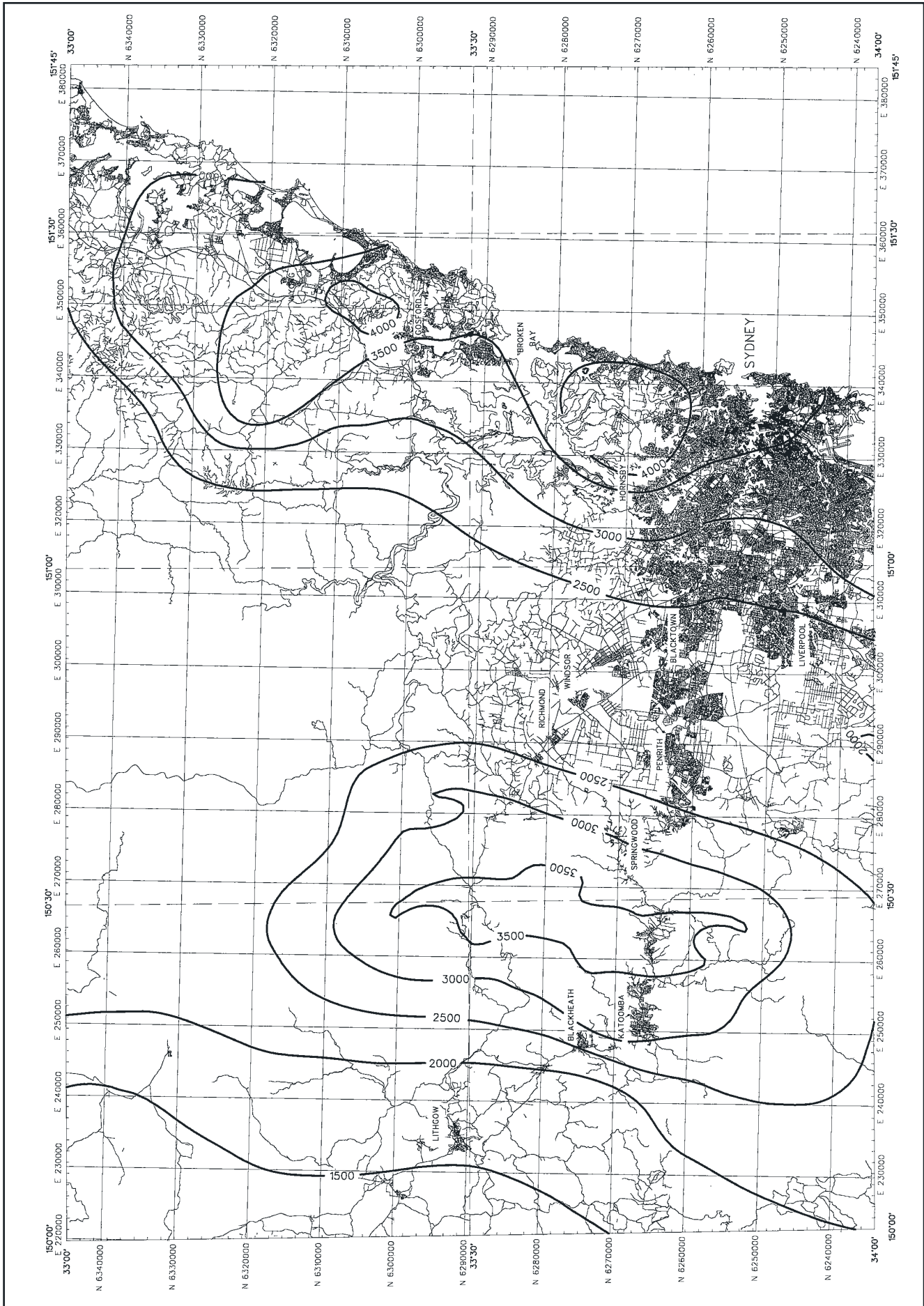
Map 7: Rainfall Erosivity of the Hastings 1:250,000 topographic Sheet



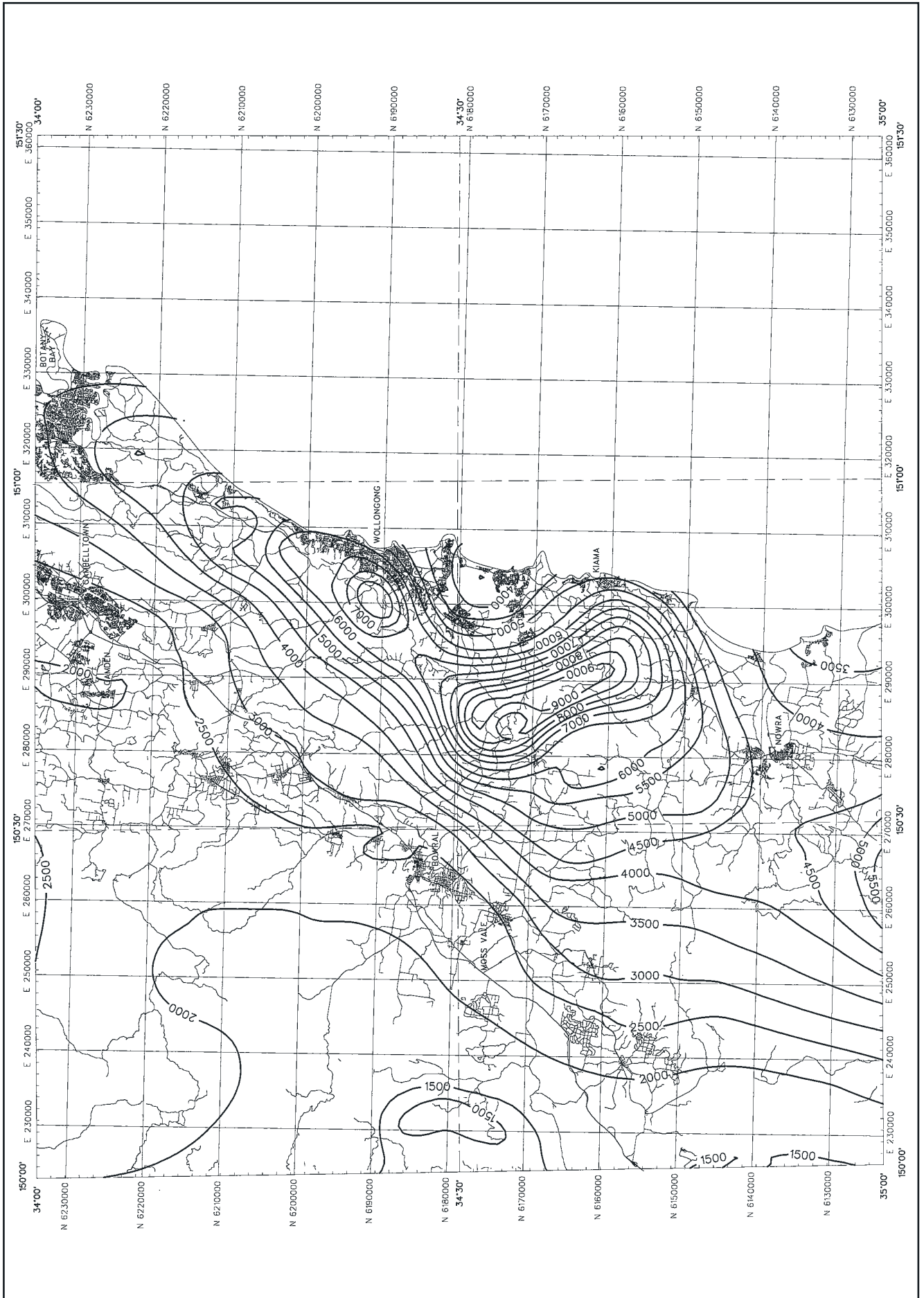
Map 8: Rainfall Erosivity of the Singleton 1:250,000 topographic Sheet



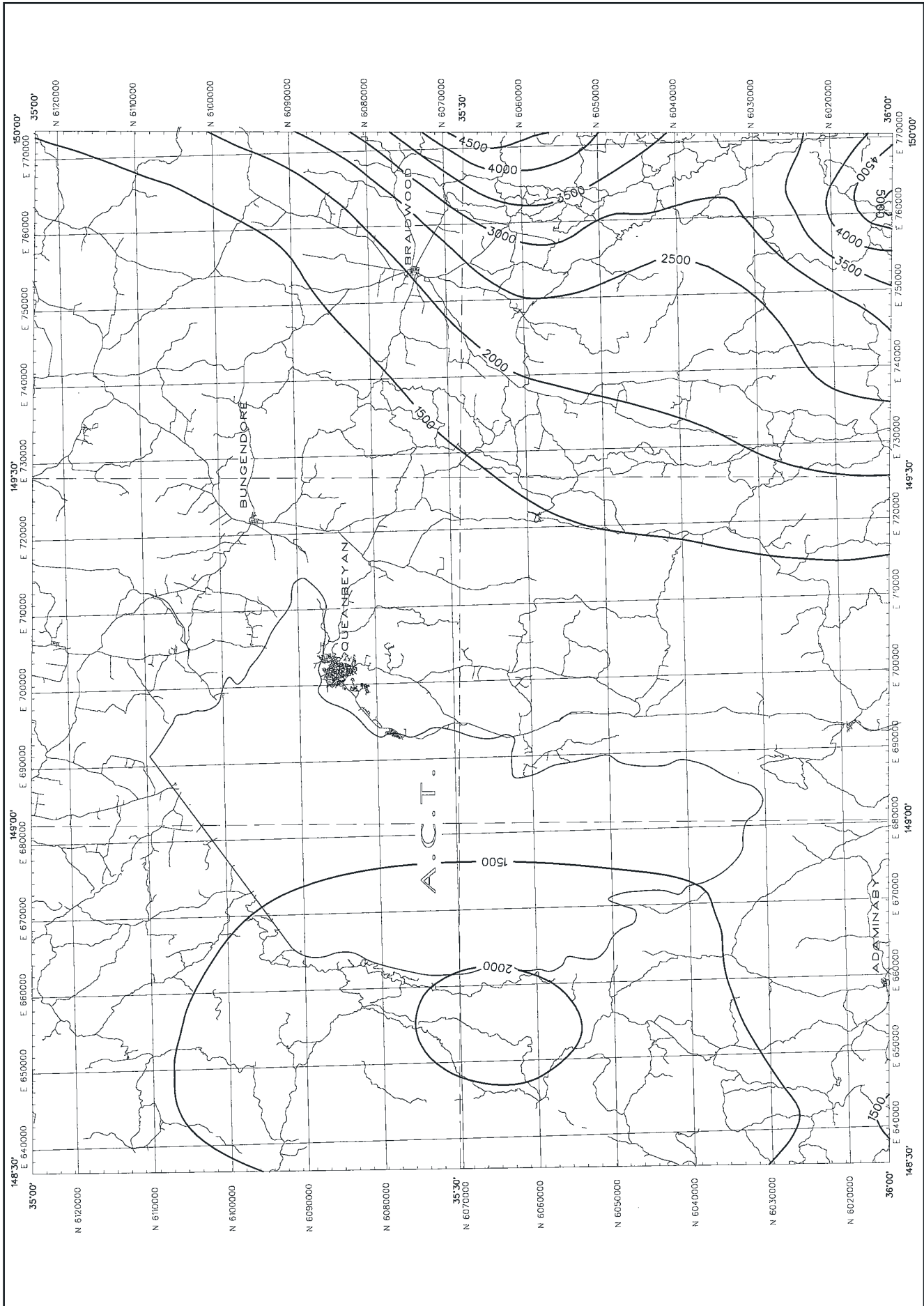
Map 9: Rainfall Erosivity of the Newcastle 1:250,000 topographic Sheet



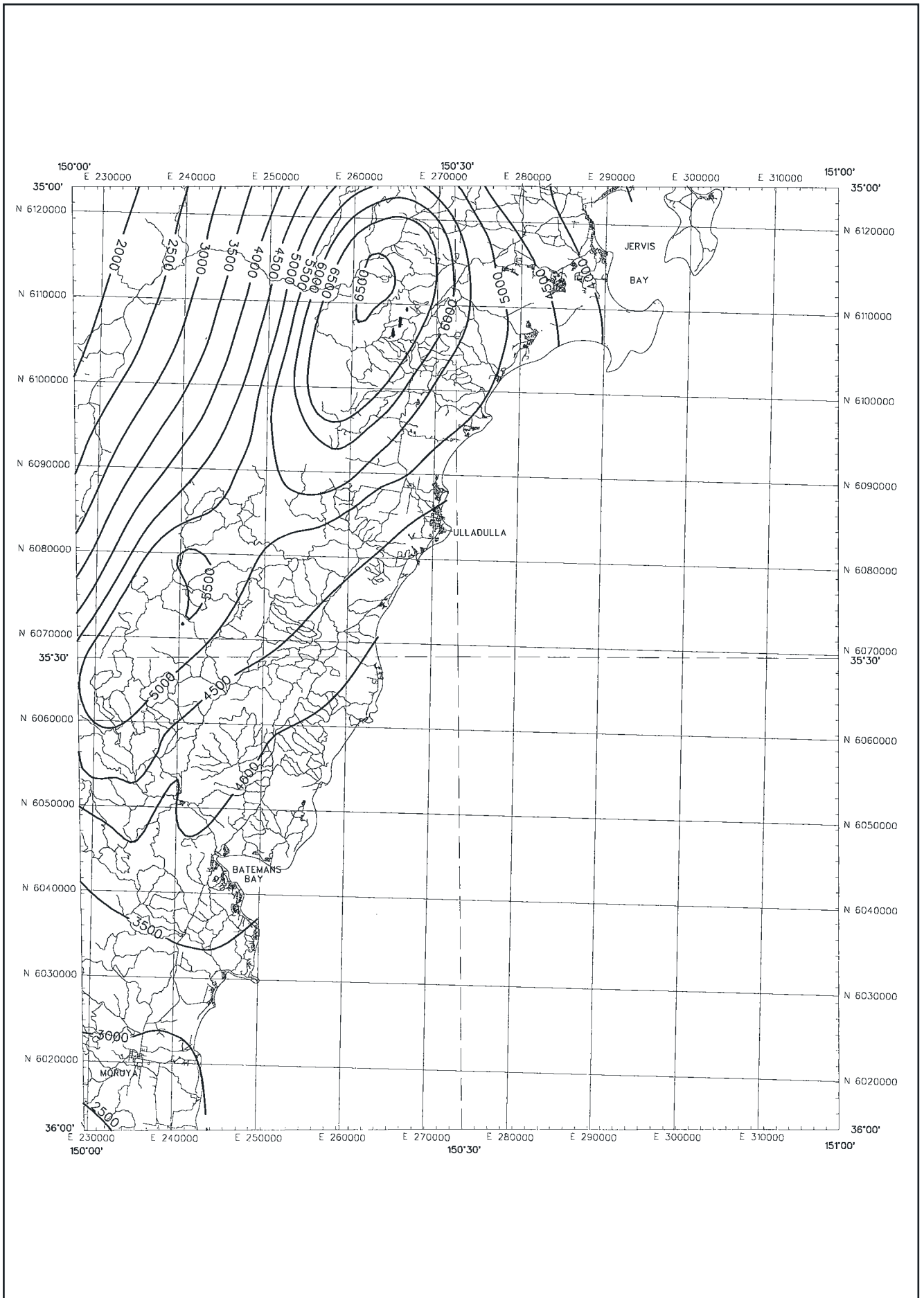
Map 10: Rainfall Erosivity of the Sydney 1:250,000 topographic Sheet



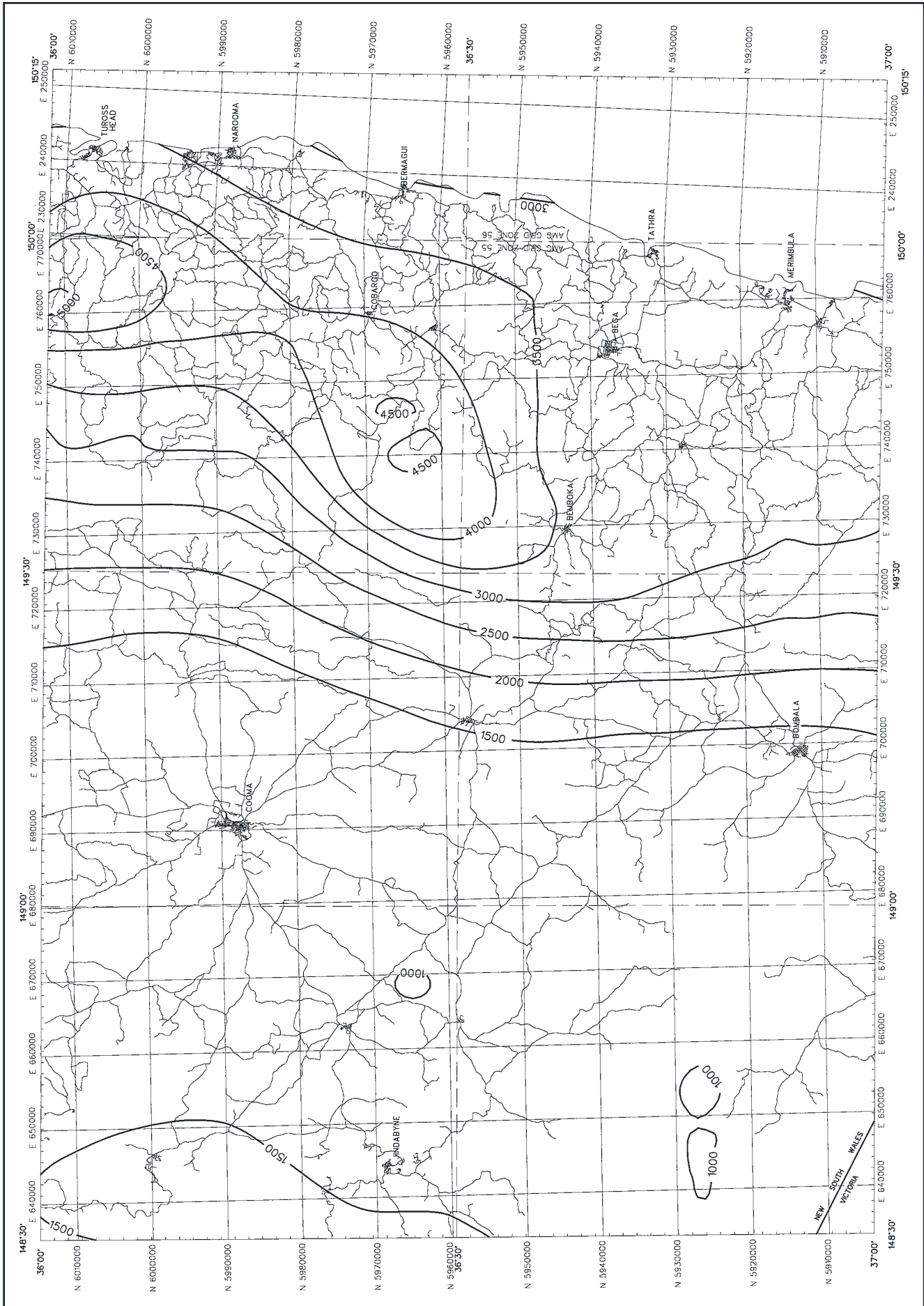
Map 11: Rainfall Erosivity of the Wollongong 1:250,000 topographic Sheet



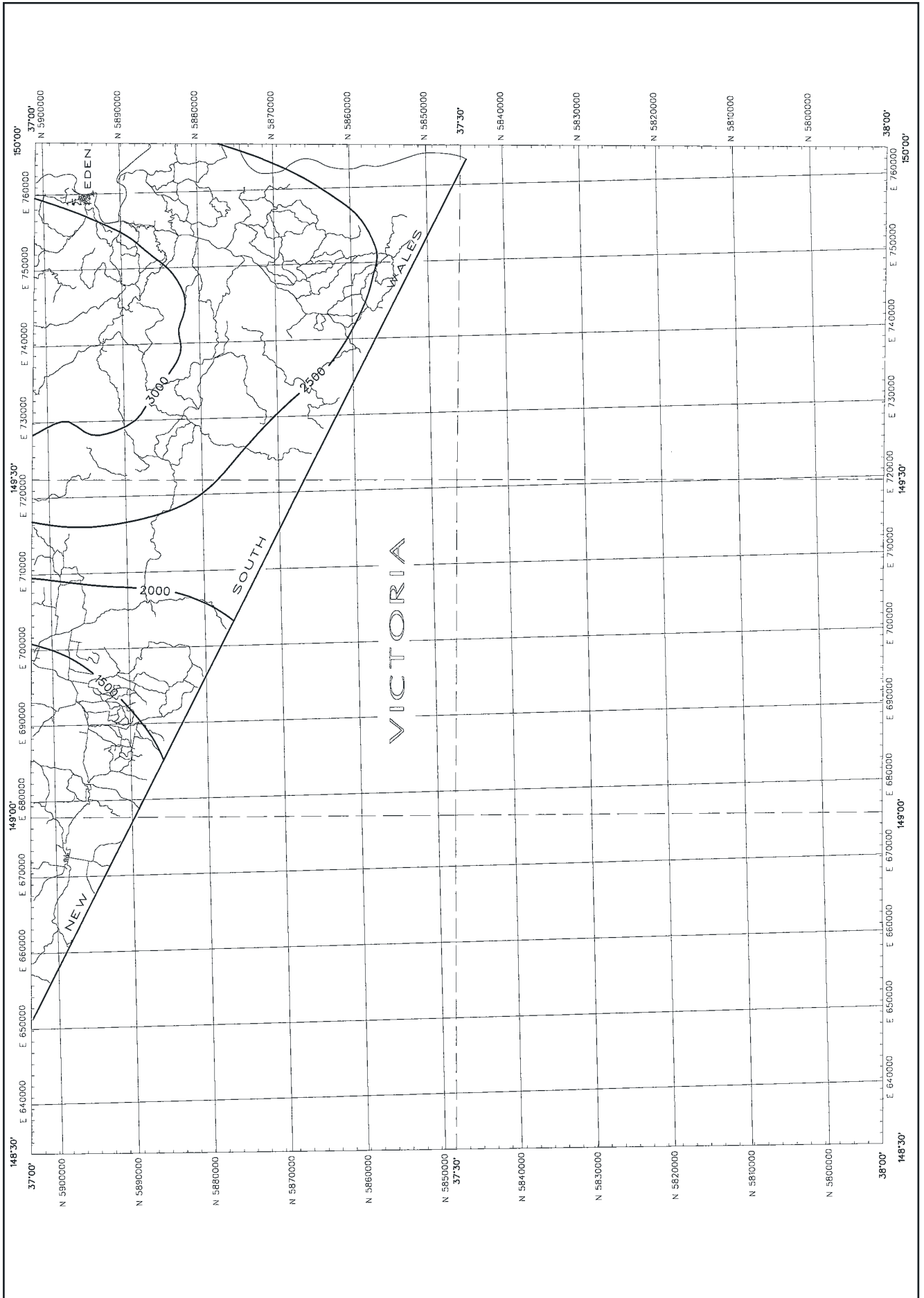
Map 12: Rainfall Erosivity of the Canberra 1:250,000 topographic Sheet



Map 13: Rainfall Erosivity of the Ulladulla 1:250,000 topographic Sheet



Map 14: Rainfall Erosivity of the Bega 1:250,000 topographic Sheet



Map 15: Rainfall Erosivity of the Mallacoota 1:250,000 topographic Sheet



APPENDIX C

C Constraints to Development

In the following tables, soil landscape names and other information have been taken from the current 1:100,000 soil landscape mapping prepared by the NSW Department of Infrastructure Planning and Natural Resources (DIPNR). Some information about constraints is presented here and can be used in fulfilment of the requirements of Chapter 3, other than on very sensitive or contentious sites. Site-specific information should be collected for these.

Understanding that these parameters are relevant to a mapping scale of 1:100 000 is important and, consequently, the described soil landscapes can include significant variations when considered at a particular location. These variations occur because mapping unit boundaries at scales of 1:100 000 allows errors of up to 250 metres of their true position, while the minimum mapping unit is about 30 hectares.

Further, the topographic position of a particular site and the specific soil forming factors that apply there can affect the soil characteristics. Variations can affect texture, structure, depth, permeability and drainage among others and so have a key role in runoff, erosion and pollution potential of exposed soil surfaces.

To improve the relevance and representativeness of the various parameters, experienced soil technicians can interpret these landscape attributes with published laboratory test results. These interpretations can give balanced assessments of soil hydrologic group, K-factor, sediment type and constraints to earthwork construction.

Arriving at the Parameters Presented in the Tables

Soil landscape

Soil landscape names and the two-letter soil layer nomenclature are drawn directly from DIPNR's 1:100 000 soil landscape maps and accompanying handbooks for NSW.

Where given, the *common constraints'* listing is derived directly from the published DIPNR soil landscape handbooks. Constraints selected are considered the most relevant to protecting the environment from the negative impacts of land disturbance.

Where given, the *typical slope gradient* is drawn directly from the published DIPNR soil landscape handbooks.

Soil Hydrologic Group

Soil Hydrologic Group refers to the parameters used in calculating runoff coefficients for different textural soil groups (Appendix F). To arrive at individual groups we have reviewed each soil landscape looking specifically at the published K_{sat} and layer depth data together with layer arrangements illustrated in the schematic cross sections. *R*-factor maps (Appendix B) and depths derived from figure F1 have been used to estimate critical layer depths. Weighting of the results has been applied based on a professional

understanding of *in situ* landscape limitations where, probably, these would override the influence of sample-based laboratory measurements.

Acid sulfate risk

Acid sulfate risk has been derived directly from the frequency with which possible acid sulfate soil (PASS) indicators have appeared in DIPNR’s samples of each landscape. The groupings correspond to the combined high and low PASS frequencies in the following way:

none	no PASS samples detected
sporadic	PASS indications in <20% of samples
common	PASS indications in 20-39% of samples
frequent	PASS indications in 40-59% of samples
widespread	PASS indications in 60-80% of samples
endemic	PASS indications in >80% of samples

Subsoil USCS and K-factor

Subsoil USCS and K-factor Data are transferred directly from the published DIPNR soil landscape handbooks.

Sediment type

Sediment type is a parameter to help in the design of sediment retention basins as described at Section 6.3.3. It is calculated from grading and dispersion data from the published DIPNR soil landscape handbooks

Sediment basin wall construction (earth)

Sediment basin wall construction (earth) Recommendations have been derived from the published DIPNR soil landscape handbooks based on information presented in Charman and Murphy (2000). While the recommendations can apply to most sediment basins, users should be aware that they are based on experience with farm dams in central and eastern New South Wales. Usually, these dams have capacities of less than 10,000 cubic metres and have top water levels less than three to four metres above the original ground surface at the upstream side of the wall. Charman and Murphy (2000) list other matters that users should consider.

The ratings are:

- A. This soil is suitable for normal use. Take care to achieve good compaction, preferably with the soil in a moist condition. If the soil is too dry (cannot be moulded without breaking), reduce the layer thickness to less than 150 mm. The recommended minimum batter grades are 1:2.5 upstream and 1:2 downstream, except CH and MH classifications when they should be decreased to 1:3 and 1:2.5, respectively.

- B. This material is similar to A, but with high compaction requirements to at least 85 percent of maximum dry density. To achieve this, the soil should be close to the optimum moisture content for the compaction plant, be placed in layers less than 150 mm thick and compacted with four complete passes of a crawler tractor or roller (or equivalent). As a general guide, the soil should be sufficiently moist to be made into a thread 10 mm thick, but not moist enough to be rolled thinner than 3 mm without breaking. The recommended minimum batter grades are 1:3 upstream and 1:2.5 downstream.

Note: the following soils in groups C to J should be assessed in terms of:

- zonal use
- mixing with other local materials and/or ameliorants.

An additional option is the importation of lining materials, such as a stable, impervious membrane or incorporating bentonite into it.

- C. This is aggregated material that might not hold water. Compact to 95 percent of maximum with at least four passes of a sheepsfoot roller when the soil is slightly wet of optimum (can be rolled into a 3-mm diameter thread). Use a vibrating roller on dry soils. An ameliorant – STPP or sodium carbonate – could be required. If the EAT is Class 6 or the dispersion percentage is less than 10, then the dam is likely to leak unless sealed with better clay or treated with an ameliorant to induce dispersion. A permeameter test may be required.
- D. This soil is highly susceptible to tunnelling or piping failure. It must be well compacted throughout to reduce permeability and saturation settlement. The soil should be compacted to at least 90 percent maximum dry density by ensuring adequate moisture content. If drier than optimum, gypsum or hydrated lime should be incorporated into the soil at rates based on laboratory testing – the method to be determined by site and equipment constraints. For additional stability, the structure should be designed to hold no more than 1 metre of water against the wall and batter grades should be decreased to 3.5:1 (H:V) upstream and 3:1 (H:V) downstream.
- E. This soil is very susceptible to tunnelling or piping failure. In addition to Recommendation D, the structure must hold no more than 1 metre depth above the original ground surface at the upstream side of the wall and not be subject to more than 0.3 metres per day draw down (trickle pipes must not be more than 0.3 metres below top water level). Gypsum or hydrated lime should be incorporated in the upstream side of the wall. The recommended upstream batter grades should be decreased to 4:1 (H:V), following compaction to 95 percent of maximum dry density.
- F. This soil is very susceptible to tunnelling or piping failure. Because of the high shrink-swell potential, the batter grades must be decreased. In addition to Recommendation D, the freeboard must be increased to at least 1 metre above the

surcharge level and hydrated lime or gypsum should be applied at rates determined in the laboratory. The batter grades should be decreased to 4:1 (H:V) upstream and 3:1 (H:V) downstream where compaction at 95 percent maximum dry density cannot be assured.

- G. The high shrink-swell potential of this soil can result in cracks extending through the wall below top water level. To reduce this possibility, a compacted central core (at least 95 percent maximum compaction) must be obtained by constructing it when the soil is at near optimal soil moisture content. The freeboard must be increased to at least 1 metre above the surcharge level to prevent surface cracks extending below the waterline. The recommended batter grades are 3.5:1 (H:V) upstream and 3:1 (H:V) downstream. The structure must be designed to retain sufficient water to keep the wall moist and minimise crack development.
- H. These soils are highly susceptible to failure and the recommendations in G are more critical to prevent failure. Compaction should be to 95 percent of maximum dry density at least, and batter grades further reduced.
- I. These soils are pervious and not recommended for general use. However, they can be used in a zoned embankment or mixed with other materials. The recommended batter grades are 3:1 (H:V) upstream and 3:1 (H:V) downstream.
- J. The use of these soils is not recommended.
- K. Usually, these soils are unsuitable for use in construction.

QUEENSLAND

1. MURWILLUMBAH
2. LISMORE - BALLINA
3. WOODBURN
4. DORRIGO
5. COFFS HARBOUR
6. MACKSVILLE
7. CURLEWIS
8. TAMWORTH
9. KEMPSEY - KOROGORO POINT
10. BLACKVILLE
11. MURRURUNDI
12. DUNGO
13. NEWCASTLE
14. PORT STEPHENS
15. WALLERAWANG
16. ST. ALBANS
17. GOSFORD - LAKE MACQUARIE
18. KATOOMBA
19. PENRITH
20. SYDNEY
21. WOLLONGONG - PORT KACKING
22. KIAMA
23. WAGGA WAGGA
24. CANBERRA
25. BRAIDWOOD
26. MICHAELAGO
27. COOMA
28. NAROOMA
29. BEGA - GOALEN POINT

23

24 25
26
27 28
29

VICTORIA

7 8
10 11

12
13 14

15 16 17
18 19 20

21
22

1
2
3

4 5
6
9



SOIL LANDSCAPE MAPS

FOR

NEW SOUTH WALES

WITH

KEY MAP DIAGRAM

DETAILED DATA ON NOMINATED
1:100000 TOPOGRAPHIC SHEETS

SCALE 1:5000000

Table C1. Murwillumbah Soil Landscapes

Table 1 Murwillumbah Soil Landscapes								
Soil landscape	Soil hydrologic group	Percent area of high acid sulfate soil risk	Acid sulfate risk	USCS class	K-factor USLE	Sediment type	Sediment basin wall construction (earth)	
Angels Beach (ab)	Group A	1.50	sporadic	SP	0.010	Type C	I	
				SP	0.014	Type C	I	
Brays Creek (bc)	Group B	0.00	none	ML	0.036	Type F	A	
				SM	0.025	Type F	I	
				ML	0.042	Type F	J	
Billinudgel (bi)	Group C	0.88	sporadic	OL	0.017	Type F	J	
				ML	0.040	Type D	J	
				CL	0.034	Type D	D	
				CL	>0.085	Type F	C	
Bald Mountain (bm)	Group C/D	0.00	none	ML	0.027	Type F	J	
Burringbar (bu)	Group B/C	0.31	sporadic	OL	0.026	Type D	J	
				CL	0.030	Type D	D	
				CL	>0.081	Type F	C	
	Group D	Group C			ML	0.041	Type D	B
					ML	0.048	Type D	B
					ML	0.054	Type D	D
					CL	>0.087	Type F	C
Byrrill (by)	Group B	0.00	none	CH	0.014	Type D	G	
				ML	0.025	Type D	J	
				CL	0.089	Type F	C	
	Group D				CL	0.018	Type D	G
					OL	0.029	Type D	J
					CH	0.015	Type F	A
					CL	0.023	Type D	A
Carool (ca)	Group D	0.00	none	OL	Peaty	Type F	J	
				Group C	OL	0.006	Type F	J
				CL	0.065	Type F	G	
				CL	0.067	Type F	C	
Cobaki (cb)	Group D	49.22	endemic	ML	>0.075	Type F	C	
				CL	>0.089	Type F	G	
				PT	Peaty	Type F	J	
				OL	Peaty	Type F	J	
Cudgera (cd)	Group C	11.63	frequent	ML	0.048	Type D	J	
				ML	0.057	Type D	B	
				ML	>0.089	Type F	C	
				CL	>0.090	Type F	C	
Crabbes Creek (cr)	Group B	0.32	sporadic	SC	0.038	Type F	B	
				SC	0.032	Type F	B	
				ML	0.034	Type F	A	
				ML	0.036	Type D	A	
				CL	0.025	Type D	A	
Cudgen (cu)	Group C/D	0.68	sporadic	CL	0.006	Type F	K	
				CL	0.015	Type F	C	
Disputed Plain (dp)	Group D	0.00	none	CH	0.019	Type F	J	
				CH	0.023	Type D	F	
Frogs Hollow (fh)	Group C	0.00	none	CL	0.026	Type D	B	
				OL	Peaty	Type F	J	
				CL	0.024	Type D	A	
				ML	0.036	Type F	J	

Table C1. Murwillumbah Soil Landscapes (continued)

Table 1 Murwillumbah Soil Landscapes							
Soil landscape	Soil hydrologic group	Percent area of high acid sulfate soil risk	Acid sulfate risk	USCS class	K-factor USLE	Sediment type	Sediment basin wall construction (earth)
				CL	0.085	Type F	C
Georgica (ge)	Group C/D	0.00	none	CH	0.036	Type D	F
				ML	0.031	Type F	J
Green Pigeon (gp)	Group B/C	0.00	none	OL	0.001	Type F	J
				CH	0.065	Type F	C
				OL	0.009	Type F	J
				ML	0.038	Type F	A
Kingscliff (ki)	Group A/B	32.02	endemic	SP	0.009	Type F	J
				SP	0.016	Type F	J
				SP	0.009	Type C	I
				CL	0.024	Type D	G
Kunghur (ku)	Group C/D	0.00	none	SC	0.029	Type F	J
				CL	0.021	Type F	G
				CL	0.069	Type F	C
				CL	0.026	Type D	A
				CL	0.021	Type D	A
	SC			0.031	Type D	B	
	Group D			SW	0.022	Type F	J
				SC	0.029	Type F	B
Limpinwood (li)	Group C	0.00	none	CL	0.030	Type D	J
				CL	0.028	Type F	J
				CH	0.032	Type D	H
	Group C/D			OL	0.009	Type F	J
				CL	0.064	Type F	C
	Group C			ML	0.049	Type F	A
				Group D	OL	0.020	Type F
	CH				0.057	Type F	G
	MH				0.071	Type F	K
	Mebbin (me)			Group D	0.00	none	SM
ML		0.044	Type F				A
Mount Terragon (mt)	Group C	0.00	none	CL	0.069	Type F	C
				CL	0.050	Type F	C
				ML	0.045	Type F	C
				CL	0.027	Type F	A
				OL	0.009	Type F	J
				CL	0.022	Type F	A
				CL	0.069	Type F	G
	Group C/D			SM	0.033	Type F	J
				CL	0.034	Type D	G
	Mount Warning (mw)			Group C	0.00	none	ML
CL		0.062	Type F				C
Group D		OL	0.009	Type F			J
		CL	0.023	Type F			J
Nobbys Creek (no)	Group D	0.24	sporadic	ML	0.034	Type F	A
				ML	0.045	Type F	A
				ML	0.041	Type F	J
				ML	0.044	Type F	C
				SP	0.011	Type C	J
Nullum (nu)	Group B	0.00	none	OL	0.017	Type F	J
				ML	0.054	Type F	I
				CL	0.041	Type D	B

Table C1. Murwillumbah Soil Landscapes (continued)

Table 1 Murwillumbah Soil Landscapes							
Soil landscape	Soil hydrologic group	Percent area of high acid sulfate soil risk	Acid sulfate risk	USCS class	K-factor USLE	Sediment type	Sediment basin wall construction (earth)
	Group D			SM-ML	0.017	Type F	J
				CL	0.042	Type F	B
Ophir Glen (og)	Group C/D	10.23	common	PT	Peaty	Type F	J
				ML	0.040	Type D	A
				OL	0.035	Type D	J
				CL	0.018	Type F	A
				ML	0.027	Type D	J
				CL	0.019	Type D	A
				ML	>0.066	Type D	J
				ML	0.040	Type D	A
Oxley (ox)	Group B/C	0.39	sporadic	ML	0.049	Type F	A
Pottsville (po)	Group B	13.39	endemic	CL	0.029	Type F	J
				SP	0.015	Type F	I
				SP	Pan	Type F	I
Pumpenbill (pu)	Group B	0.00	none	ML	0.029	Type F	J
				CL	0.047	Type F	G
				CL	0.019	Type F	C
				OL	0.014	Type F	J
				CL	0.055	Type F	C
Rous (ru)	Group B	0.02	sporadic	ML	0.037	Type F	J
				SC	0.036	Type F	I
				SM	0.034	Type F	B&I
				CL	0.036	Type F	B
Tweed (tw)	Group C/D	88.07	endemic	ML	0.025	Type F	J
				SC	0.022	Type F	C
				OL	Peaty	Type F	J
				ML	0.050	Type F	A
				MH	0.048	Type F	A
				MH	0.030	Type D	B
				CL	0.041	Type D	E
				CH	0.035	Type D	J
				CH	0.039	Type D	G
Ukerabagh (uk)	inapplicable	96.12	endemic	ML	0.047	Type D	J
				CL	0.048	Type D	D
				OL	0.028	Type F	J
				PT	Peaty	Type F	J
				SP	0.025	Type F	J
Wollumbin (wl)	Group C	0.00	none	PT	Peaty	Type F	J
				ML	0.027	Type D	A
				CL	0.025	Type F	A
				CL	>0.089	Type F	C
Wooyung (wy)	Group A	0.80	endemic	SP	0.013	Type F	J
				SP	0.000	Type C	I
				SP	0.010	Type C	I
				SP	0.013	Type F	I

Table C2. Lismore-Ballina Soil Landscapes

Soil landscape	Common constraints	Slope range (%)	Soil hydrologic group	Acid sulfate risk	USCS Class	K-factor USLE	Sediment type	Sediment basin wall construction (earth)
Angels Beach (ab)	non cohesive dune materials; high wind and wave erosion hazards; waterlogging in some low areas; widespread risk to foundations	20 to 50	Group A	sporadic	SW	0.014	Type F	I
Bagotville (ba)	steep slopes and shallow soils; localised rock outcrop; localised mass movement and rock fall hazards; waterlogging and flooding in some low areas; localised non cohesive soils; localised risks to foundations	10 to 30	Group C/D	sporadic	SM	0.025	Type F	J
			Group B/C		CL	0.005	Type F	J
					CL	0.031	Type D	D
					CL-CH	0.016	Type D	A
Bangalow (bg)	generally steep slopes; widespread mass movement hazard; localised shallow soils upslope and waterlogging in low areas; localised risks to foundations	15 to 25	Group C	sporadic	MH	0.011	Type F	C
					MH-CH	0.011	Type F	C
Billinudgel (bi)	generally shallow soils; some localised steep slopes subject to mass movement	10 to 20+	Group C	sporadic	ML-MH	0.019	Type F	J
					CL	0.028	Type F	B
					CL	0.022	Type D	B
					CL	0.037	Type D	D
Burns Point (bp)	widespread waterlogging and flood hazard areas; localised risk of wave erosion; widespread risks to foundations	<2	Group D	endemic	SW	0.005	Type C	I
					ML	Peaty	Type D	K
					SM	0.013	Type F	B&I
					CL	0.034	Type D	A
Black Rock (br)	widespread non cohesive soils subject to wind erosion; permanently high watertables in low areas; localised risks to foundations	<5	Group A	endemic	SM	0.000	Type C	J
			Group D		SM	0.004	Type C	I
					PT	Peaty	Type F	J
Burringbar (bu)	generally steep slopes; widespread mass movement hazard; localised shallow soils upslope; widespread risks to foundations	15 to 33+	Group B	sporadic	CL	0.028	Type F	B
					ML-CL	0.035	Type F	D
					CL	0.034	Type D	D
Coffee Camp (cc)	localised steep slopes with general risk of mass movement and localised rock falls; shallow soils, and rock outcrop upslope; localised non cohesive soils; widespread risk to foundations	10 to 20	Group A	sporadic	SC	0.012	Type F	C
					CL	0.062	Type F	C
					SM	0.016	Type F	J
					CL-CH	0.023	Type F	G
Coraki (ck)	generally non cohesive soils; seasonal waterlogging in some low areas	2 to 10	Group A/B	sporadic	ML	0.016	Type F	I
					ML	0.024	Type F	A
					CH	0.010	Type F	G
Calico (ci)	generally steep slopes; widespread mass movement hazard;	10 to 25	Group C	none	CL	0.040	Type D	J

Table C2. Lismore-Ballina Soil Landscapes (continued)

Soil landscape	Common constraints	Slope range (%)	Soil hydrologic group	Acid sulfate risk	USCS Class	K-factor USLE	Sediment type	Sediment basin wall construction (earth)
	generally high erosion hazard; localised shallow soils upslope and waterlogging in low areas; widespread risks to foundations				CH CL-CH CL-CH CL CL	0.024 0.021 0.012 0.017 0.029	Type F Type F Type F Type F Type F	G C C J A
Coolamon (co)	generally steep slopes, widespread risk of mass movement; shallow soils, and rock outcrop upslope; localised non cohesive soils; widespread risk to foundations	20 to 60	Group C	sporadic	MH MH-CH	0.011 0.011	Type F Type F	C C
Disputed Plain (dp)	permanently high waterables; localised waterlogging in some low areas; widespread risk to foundations	1 to 3	Group C/D	sporadic	CH CH	0.010 0.009	Type D Type D	H H
Dungarubba (du)	permanently high waterables; widespread waterlogging and flooding in low areas; widespread risk to foundations	<1	Group C/D	endemic	MH MH	Peaty Peaty	Type F Type F	A C
East Ballina (eb)	generally non cohesive soils subject to wind erosion; seasonal waterlogging in lower areas	3 to 10	Group A	sporadic	SP SP	0.003 0.001	Type C Type C	J nt
Eltham (el)	widespread water erosion and flooding hazards; localised mass movement; widespread risks to foundations	<2	Group C	none	CL CL	0.029 0.045	Type F Type F	J C
Empire Vale (ep)	generally high waterables; widespread flooding hazard; widespread risks to foundations	<1	Group C/D	endemic	MH-CH CH CL CH	0.023 0.050 0.029 0.043	Type F Type D Type D Type D	H D J D
Ewingsdale (ew)	localised rock outcrop and mass movement; waterlogging in some low areas	3 to 10	Group C	sporadic	MH CL	0.033 0.029	Type F Type F	C G
Frederick (fr)	generally shallow soils and localised rock outcrop; wide_spread waterlogging; localised risks to foundations		Group C/D	none	CL CH	0.030 0.013	Type F Type D	B G
Georgica (ge)	generally steep slopes, localised shallow soils; widespread mass movement, localised rock falls; some seasonal waterlogging in low areas; widespread risk to foundations	15 to 30	Group B	none	CL-CH CH ML CL CL	0.016 0.045 0.052 0.024 0.033	Type F Type D Type D Type F Type F	K/H H B B A

Table C2. Lismore-Ballina Soil Landscapes (continued)

Soil landscape	Common constraints	Slope range (%)	Soil hydrologic group	Acid sulfate risk	USCS Class	K-factor USLE	Sediment type	Sediment basin wall construction (earth)
Leycester (le)	widespread water erosion and flooding hazards; localised mass movement; widespread risks to foundations	<2	Group C	common	CL-CH CL-CH	0.036 0.049	Type F Type F	B/A G
Mackellar (ma)	generally steep slopes; widespread risk of mass movement; shallow soils, and rock outcrop upslope; widespread risk to foundations	<50	Group C	none	CL-CH CL-CH CL-CH	0.038 0.044 0.064	Type F Type F Type F	B/A B/A B/A
Mount Burrel (mb)	generally steep slopes and rock outcrop, localised shallow soils; widespread mass movement and rock falls; some seasonal waterlogging in low areas; widespread risk to foundations	20 to 50	Group C/D	none	CL CL CL MH-CH	0.009 0.016 0.016 0.005	Type F Type F Type F Type D	J G G H
McKee (mc)	generally shallow soils; localised steep slopes widespread mass movement; seasonal waterlogging in some low areas; localised risks to foundations	<10	Group C	sporadic	CH SC-CL	0.009 0.025	Type F Type F	H C
Minyon (mi)	localised steep slopes; shallow soils and rock outcrop upslope; seasonal waterlogging in some low areas	10 to 15	Group C	none	ML-CL ML-CL ML-CL CL	0.014 0.021 0.045 0.026	Type F Type F Type F Type F	D D B D
Mullumbimby (mu)	widespread seasonal waterlogging and localised flooding hazard in low areas	<1	Group B/C Group C	frequent	MH-CH MH MH	0.020 Peaty 0.029	Type F Type F Type F	C C A
Myocum (my)	generally high waterables and widespread waterlogging; localised flood hazards; widespread risks to foundations	<2	Group C	frequent	CL-CH CL-CH	0.000 0.000	Type F Type F	G/C H
Nammoona (na)	generally high water erosion hazards; localised steep slopes, shallow soils; some localised mass movement	10 to 18	Group C	none	CL ML CH CH-MH	0.082 0.048 0.011 0.013	Type F Type F Type F Type F	D J J J
North Casino (nc)	generally high waterables and widespread waterlogging; general flooding hazard; widespread risks to foundations	<2	Group D	common	CH	0.016	Type D	H
Nightcap (ni)	generally steep slopes and shallow soils; widespread mass movement; widespread risks to foundations	20 to 50+	Group B/C	none	MH CH CL	0.016 0.023 0.031	Type F Type F Type F	C C J

Table C2. Lismore-Ballina Soil Landscapes (continued)

Soil landscape	Common constraints	Slope range (%)	Soil hydrologic group	Acid sulfate risk	USCS Class	K-factor USLE	Sediment type	Sediment basin wall construction (earth)
Rosebank (ro)	generally steep slopes widespread mass movement hazard; localised shallow soils upslope; waterlogging in some low areas; localised rock outcrop; widespread risks to foundations	20 to 40	Group C	none	MH MH-CH	0.018 0.040	Type F Type F	C C
Sandy Creek (sc)	widespread water erosion hazard; permanently high waterables, widespread waterlogging and localised flooding in low areas;	<5	Group B	common	SM CL CL ML-CL CL-CH	0.054 0.033 0.047 0.027 >0.085	Type F Type D Type F Type D Type F	nt B B D G/C
Tatham (ta)	generally high waterables, localised flooding and widespread seasonal waterlogging; widespread risks to foundations	<5	Group C/D	sporadic	CL CL-OH CH CH	0.046 Peaty 0.016 0.005	Type F Type F Type F Type D	B J H D
Terania (te)	widespread water erosion hazards; seasonal waterlogging and flooding of low areas; localised mass movement; localised risks to foundations	<3	Group C	none	CL CL	0.038 0.046	Type F Type F	C B
Tuckean (tu)	generally high waterables; general flooding hazard; widespread risks to foundations	<1	Group D	endemic	SM OL CL	Peaty Peaty 0.026	Type F Type F Type F	J J C
Tyagarah (ty)	generally high waterables; widespread waterlogging; general risk of wind erosion; localised risks to foundations	<1	Group C/D	endemic	SM SM ML	0.000 0.020 0.020	Type F Type F Type D	J J A
Wollongbar (wo)	localised mass movement hazards	3 to 15	Group B	sporadic	CL-CH CL-CH	0.007 0.059	Type F Type F	C C
Yorklea (yo)	generally high water erosion hazards; seasonal waterlogging and localised flooding in low areas; localised shallow soils upslope	2 to 10	Group C/D	sporadic	ML CL CH CL	0.053 0.024 0.013 0.051	Type F Type D Type D Type D	B A A A

Table C3. Woodburn Soil Landscapes

Table 3 Woodburn Soil Landscapes									
Soil landscape	Soil hydrologic group	Percent area of high acid sulfate soil risk	Acid sulfate risk	Percent area of low acid sulfate soil risk*	USCS Class	K-factor USLE (t.ha.h/ha.MJ.mm)	Sediment type	Sediment basin wall construction (earth)	
Angels Beach (ab)	Group A	0.02	sporadic	1.42	SM	0.016	Type F	J	
					SM	0.014	Type F	J	
					SM	0.007	Type C	J	
					SM	0.009	Type F	J	
					SM	0.002	Type C	I	
Angourie (an)	inapplicable	0.15	common	29.46	SM	Peaty	Type F	J	
					SM	0.011	Type C	J	
					SP-SM	0.000	Type C	J	
					Group B/C	SP-OL	0.016	Type C	J
					SP-SM	0.000	Type C	J	
					PT	Peaty	Type F	J	
					PT	Peaty	Type F	J	
The Broadwater (bd)		99.74	endemic	0.00	ML	0.061	Type D	B	
					SM-ML	0.056	Type F	B&I/A	
					ML	>0.087	Type F	C	
Bundjalung (bj)	inapplicable	2.18	common	27.46	SM	Peaty	Type C	J	
					SP-SM	0.000	Type C	J	
					OL	0.031	Type F	J	
					CL	0.029	Type F	J	
					SC-CL	0.019	Type F	J	
					SM	0.023	Type F	I	
					SM	0.000	Type C	I	
Bungawalbin (bw)	inapplicable	18.66	widespread	57.16	PT	Peat	Type F	J	
					OL	0.024	Type D	J	
					CH	0.018	Type D	H	
					CH	0.016	Type D	H	
					Group C/D	SM	0.026	Type F	I
					SM	0.029	Type F	B&I	
					SC	0.036	Type F	C	
					SC	0.038	Type F	C	
					Group B	SM	0.032	Type F	J
					SM	0.030	Type F	J	
					SM	0.026	Type F	nt	
					SP-ML	0.051	Type F	I	
					CL	0.044	Type F	G	
					Group B/C	OL	0.037	Type F	J
					MH	0.038	Type F	J	
					CH	0.025	Type D	A	
					CH	0.021	Type D	G	
					ML	0.049	Type F	A	
					Group C/D	OL	>0.028	Type F	J
					ML	>0.059	Type D	D	
ML	0.034	Type D	A						
CL	0.027	Type D	G						

Table C3. Woodburn Soil Landscapes (continued)

Table 3 Woodburn Soil Landscapes									
Soil landscape	Soil hydrologic group	Percent area of high acid sulfate soil risk	Acid sulfate risk	Percent area of low acid sulfate soil risk*	USCS Class	K-factor USLE (t.ha.h/ha.MJ.mm)	Sediment type	Sediment basin wall construction (earth)	
Cahills Road (ch)	Group C	0.15	sporadic	0.01	OL	0.027	Type F	J	
					CH	0.020	Type D	G	
					ML	0.039	Type F	A	
					CH	0.033	Type D	G	
	Group C/D					CL	0.051	Type D	D
						SM	0.028	Type F	J
						SC	0.032	Type F	B
						CL	0.014	Type D	A
	Group D					CL	0.026	Type D	A
						SM	0.049	Type F	J
						SM	0.056	Type F	J
						CL	0.031	Type D	B
	Group C/D					CL	0.035	Type D	B
						SM	0.012	Type F	J
						CL	0.014	Type F	A
						CL	0.017	Type F	A
	Group C					SC-CL	0.024	Type F	B/A
ML						0.032	Type F	A	
CL						0.024	Type D	G	
Coraki (ck)	Group B	1.95	sporadic	0.48	SM	0.016	Type F	I	
					SM	0.024	Type F	I	
					GM	0.026	Type C	I	
					SM	0.051	Type F	I	
	Group B					SM	0.015	Type F	J
						SM	0.019	Type F	I
						SM	0.025	Type F	I
	Group B					SM	0.019	Type F	J
						SM	0.021	Type F	I
					SM	Pan	Type F	I	
Cowper (cw)	Group B	99.39	endemic	0.00	ML	0.048	Type F	J	
					ML	0.048	Type F	J	
					SM	0.052	Type F	I	
	Group C/D					ML	0.050	Type D	J
						ML	0.053	Type D	A
Cliff Road (cx)	Group C/D	0.17	sporadic	0.03	SM	0.034	Type D	J	
					SM	0.042	Type F	J	
					SC	0.028	Type D	B	
	Group D					SM	0.000	Type C	I
						SM	0.003	Type C	I
	Group C/D					SM	0.003	Type C	J
						SM	0.011	Type C	I
						SM	0.017	Type C	I
						SC	0.019	Type F	B
	Group D					SM	0.017	Type F	J

Table C3. Woodburn Soil Landscapes (continued)

Table 3 Woodburn Soil Landscapes								
Soil landscape	Soil hydrologic group	Percent area of high acid sulfate soil risk	Acid sulfate risk	Percent area of low acid sulfate soil risk*	USCS Class	K-factor USLE (t.ha.h/ha.MJ.mm)	Sediment type	Sediment basin wall construction (earth)
Dungarubba (du)	Group D	88.69	endemic	8.11	SM	0.023	Type F	I
					ML	0.026	Type D	B
					CL	0.027	Type D	B
	Group C	88.69	endemic	8.11	PT	Peaty	Type F	J
					CL	0.027	Type F	J
					CL	>0.089	Type F	C
					ML	0.055	Type F	J
					CL	0.036	Type D	B
					CL	0.036	Type F	B
					PT	Peaty	Type F	J
PT	Peaty	Type F	J					
OL	Peaty	Type D	J					
Devils Pulpit (dv)	Group D	0.13	sporadic	0.00	SM	0.009	Type C	J
					SM	0.010	Type C	J
					SM	0.008	Type C	J
					SM	0.017	Type F	J
					SM	0.026	Type F	J
					CL	0.041	Type D	D
					SM	0.021	Type F	J
					SM	0.036	Type F	J
					SM	0.049	Type F	J
					CL	0.046	Type D	D
Ellangowan (eg)	Group A/B	0.05	sporadic	0.07	SM	0.017	Type F	J
					SM	0.037	Type F	I
					SC	0.025	Type F	B
	Group B/C	0.05	sporadic	0.07	SM	0.044	Type F	J
					SM	0.047	Type F	J
					ML	0.076	Type F	C
	Group D	0.05	sporadic	0.07	OL	Peaty	Type F	J
					ML	0.047	Type D	B
					CL	0.040	Type F	B
					CL	>0.091	Type F	C
	Group C	0.05	sporadic	0.07	SM	0.027	Type F	J
					SM	0.049	Type F	J
					CL	0.024	Type F	G
					CH	0.020	Type D	A
	Group B/C	0.05	sporadic	0.07	OL	0.019	Type F	J
					MH	0.040	Type D	E
					CL	0.031	Type D	D
SP-CL					0.015	Type F	K/G	
Evans River (er)	Group C	54.80	endemic	40.94	SP-OL	0.020	Type F	J
					ML	0.033	Type F	C
					SM	0.043	Type F	I
					SC	0.038	Type F	C

Table C3. Woodburn Soil Landscapes (continued)

Table 3 Woodburn Soil Landscapes								
Soil landscape	Soil hydrologic group	Percent area of high acid sulfate soil risk	Acid sulfate risk	Percent area of low acid sulfate soil risk*	USCS Class	K-factor USLE (t.ha.h/ha.MJ.mm)	Sediment type	Sediment basin wall construction (earth)
	inapplicable				SC	0.037	Type F	C
	inapplicable				OL	0.031	Type D	J
	inapplicable				OL	0.022	Type D	J
	inapplicable				SC	0.029	Type F	C
	inapplicable				SC	0.021	Type C	I
Everlasting (ev)	Group C/D	87.92	endemic	8.65	CL	>0.064	Type F	G
					ML	0.055	Type F	C
					CH	0.027	Type F	C
					CH	0.037	Type F	C
					CH	0.032	Type F	C
	inapplicable				PT	Peaty	dp% not	J
	inapplicable				PT	Peaty	Type F	J
					ML	>0.077	Type F	C
					ML	>0.088	Type F	C
					ML	>0.084	Type F	C
					ML	>0.072	Type F	nt
Gibberagee (gi)	Group D	0.00	none	0.00	SM	0.046	Type F	J
					SM	0.043	Type F	I
					CH	0.021	Type D	H
					CH	0.022	Type D	F
	Group C/D				SC	0.027	Type D	B
	Group C/D				SM	0.048	Type F	J
	Group C/D				SM	0.050	Type F	J
	Group C/D				CH	0.022	Type F	H
	Group C/D				CH	0.029	Type D	H
	Group C/D				CL	0.030	Type D	G
	Group D				SM	0.040	Type F	J
	Group D				SM	0.012	Type F	J
	Group D				SC	0.023	Type F	B
	Group D				SC	0.031	Type D	B
Gulmarrad (gu)	Group C	0.47	sporadic	0.63	SM	0.041	Type F	J
					SM	0.040	Type F	J
					CL	0.023	Type F	H
					ML	0.058	Type F	J
					CL	0.041	Type F	B
					CL	0.024	Type F	A
					CH	>0.094	Type F	C
					CL	0.023	Type D	B
					CL	0.043	Type F	C
	Group C/D				OL	0.015	Type F	J
	Group C/D				ML	0.031	Type F	A
	Group C/D				ML	0.047	Type F	A
	Group B/C				SM	0.014	Type F	J
	Group B/C				SC	0.008	Type F	J
	Group B/C				CH	0.018	Type D	B

Table C3. Woodburn Soil Landscapes (continued)

Table 3 Woodburn Soil Landscapes								
Soil landscape	Soil hydrologic group	Percent area of high acid sulfate soil risk	Acid sulfate risk	Percent area of low acid sulfate soil risk*	USCS Class	K-factor USLE (t.ha.h/ha.MJ.mm)	Sediment type	Sediment basin wall construction (earth)
					CL	0.026	Type D	B
	Group C				OL	Peaty	Type F	J
					OL	0.024	Type F	J
					CH	0.020	Type D	A
					CH	>0.080	Type F	C
					CH	>0.086	Type F	C
	Group D				PT	Peaty	Type F	J
					ML	0.049	Type D	J
					CL	0.030	Type D	A
					CL	0.024	Type D	A
					CL	>0.091	Type F	C
	Group C/D				OL	0.028	Type F	J
					SM	0.020	Type D	J
					SM	0.024	Type F	B&I
	Group D				ML	0.075	Type D	J
					ML	0.059	Type F	I
					CH	0.031	Type F	G
					CH	0.028	Type D	B
	Group B/C				SM	0.032	Type F	J
					SM	0.038	Type F	I
					SC	0.028	Type F	B
					SC-CL	0.024	Type F	G
	Group C				SM	0.007	Type C	J
					SM	0.043	Type F	J
					SM	0.042	Type F	J
					SM	0.034	Type D	J
	Group C/D				ML	0.032	Type F	A
					CL	0.047	Type F	C
					ML	0.048	Type F	J
					CL	0.041	Type F	B
					CL	0.034	Type D	A
Iluka (il)	Group B	9.70	endemic	71.67	SM	0.011	Type F	J
					SM	0.005	Type F	J
					SM	0.017	Type F	I
					SM	0.009	Type C	I
	Group A				SC	0.040	Type F	J
					SM	0.048	Type F	I
					SM	0.052	Type F	I
					SP-SM	0.001	Type C	J
					SP-SM	0.002	Type C	J
					SM	0.003	Type C	nt
Jerusalem Creek (je)	Group B	3.58	frequent	66.36	SC	Peaty	Type F	J
					SC	0.019	Type C	J
					SP-SM	0.000	Type C	I
	Group B/C				SM	0.003	Type C	I
					OL	0.018	Type F	J

Table C3. Woodburn Soil Landscapes (continued)

Table 3 Woodburn Soil Landscapes									
Soil landscape	Soil hydrologic group	Percent area of high acid sulfate soil risk	Acid sulfate risk	Percent area of low acid sulfate soil risk*	USCS Class	K-factor USLE (t.ha.h/ha.MJ.mm)	Sediment type	Sediment basin wall construction (earth)	
					PT	Peaty	Type F	J	
Kooyong (ky)	Group C/D	0.06	sporadic	0.02	SM	0.032	Type F	J	
					SM	0.039	Type F	J	
					SC	0.024	Type F	B	
	Group D					SM	0.010	Type F	J
						SM	0.013	Type F	J
	Group C/D					SM	0.012	Type F	J
						SM	0.034	Type F	J
						SC-CL	0.016	Type F	B/A
						SC	0.018	Type F	B
						SM	0.006	Type C	J
						SM	0.013	Type C	I
						SM	0.011	Type C	I
Lawrence (la)	Group B/C	1.77	sporadic	0.83	ML	0.045	Type F	J	
					ML	0.059	Type F	I	
					CL	0.033	Type D	E	
					CL	0.038	Type D	D	
	Group C/D					ML	0.028	Type D	J
						CL	0.016	Type F	A
						CL	0.022	Type D	B
						CL	0.023	Type D	B
	Group B					OL	0.025	Type F	J
						ML	0.060	Type D	D
						CH	0.034	Type D	G
						CH	0.034	Type D	G
						ML	0.033	Type F	C
						CL	>0.088	Type F	G
CL	0.060	Type F	G						
Lockleys Road (lo)	Group A	0.47	sporadic	0.11	SM	0.009	Type C	J	
					SM	0.009	Type C	J	
					SM	0.014	Type F	J	
					SM	0.038	Type F	B&I	
	Group B					SM	0.027	Type F	J
						SM	0.038	Type F	J
						SM	0.039	Type F	J
						SM	0.039	Type F	J
	Group A					SC	0.035	Type D	I
						SM	0.013	Type C	J
						SM	0.013	Type C	J
						SM	0.031	Type F	J
						SM	0.009	Type F	J
						SM	0.017	Type F	I
						SM	Pan	Type F	I
						SM	Pan	Type F	I
SM	Pan	Type F	I						

Table C3. Woodburn Soil Landscapes (continued)

Table 3 Woodburn Soil Landscapes													
Soil landscape	Soil hydrologic group	Percent area of high acid sulfate soil risk	Acid sulfate risk	Percent area of low acid sulfate soil risk*	USCS Class	K-factor USLE (t.ha.h/ha.MJ.mm)	Sediment type	Sediment basin wall construction (earth)					
McKee (mc)	Group B	0.00	none	0.00	SM	0.014	Type F	J					
					SP-ML	0.018	Type F	J					
					SM	0.015	Type F	J					
					SC	0.031	Type F	B					
	Group C/D				ML	0.053	Type F	J					
					CL	0.035	Type F	J					
					CL	0.041	Type F	H					
					CL	0.021	Type F	H					
					SP-ML	0.048	Type F	VA					
					OL	Peaty	Type F	J					
					MH	0.044	Type F	J					
					CH	0.019	Type D	H					
	Group C/D				CH	0.029	Type F	H					
					MH	0.039	Type F	B					
					New Italy (ne)	Group D	1.28	sporadic	0.89	OL	0.028	Type D	J
										ML	0.052	Type D	B
CL		>0.080	Type F	G									
CL		>0.082	Type F	G									
Group C/D		CL	>0.096	Type F		G							
		OL	0.037	Type D		J							
		ML	0.065	Type D		nt							
		CL	0.029	Type D		A							
	CL	0.027	Type D	G									
	Group B	SM	0.025	Type F		J							
SM		0.031	Type F	J									
SM		0.042	Type F	J									
SM		0.045	Type F	J									
Group A	ML	0.015	Type D	J									
	ML	0.021	Type D	A									
	CL	0.014	Type D	B									
	CH	0.009	Type D	A									
	CH	0.033	Type F	G									
	Olive Gap (ol)	Group C/D	0.26	sporadic	0.77	OL	Peaty	Type F	J				
SP-ML						0.054	Type F	J					
CL						0.031	Type F	A					
CL						0.038	Type D	B					
Group C		SM				0.020	Type F	J					
		SM				0.033	Type F	J					
		CL				0.026	Type F	A					
		CL				0.027	Type F	A					
Group C/D		SM				0.040	Type F	J					
		SM				0.047	Type F	J					
		SC				0.035	Type D	B					
Group D		SM				0.033	Type F	J					
		SM				0.035	Type F	J					

Table C3. Woodburn Soil Landscapes (continued)

Table 3 Woodburn Soil Landscapes								
Soil landscape	Soil hydrologic group	Percent area of high acid sulfate soil risk	Acid sulfate risk	Percent area of low acid sulfate soil risk*	USCS Class	K-factor USLE (t.ha.h/ha.MJ.mm)	Sediment type	Sediment basin wall construction (earth)
					SM	0.037	Type F	J
					SP-CL	0.026	Type D	J/B
					CL	0.038	Type F	A
	Group C/D				SM	0.028	Type F	J
					SM	0.043	Type F	J
					SP-CH	0.022	Type D	I/A
					SC	0.035	Type D	B
Palmers Island (pa)	Group C/D	99.13	endemic	0.16	CL	0.036	Type D	J
					CL	0.043	Type D	B
					ML	0.054	Type D	B
					ML	0.066	Type D	D
					ML	0.071	Type F	I
					ML	0.067	Type F	A
Physics Lagoon (pl)	Group C	0.00	none	0.00	ML	Peaty	Type F	J
					ML	0.037	Type F	J
					SM	0.047	Type F	J
	Group C/D				PT	Peaty	Type F	J
					CL	0.033	Type D	B
					CL	0.026	Type D	B
					CL	0.022	Type D	B
	Group C/D				PT	Peaty	Type F	J
					OL	Peaty	Type D	J
					CH	0.020	Type D	G
	Group B				SP-SM	0.000	Type C	J
					SP-SM	0.000	Type C	J
					SM	0.000	Type C	J
					SP-SM	0.000	Type C	J
	Group B/C				SM	0.025	Type F	J
					SM	0.037	Type F	nt
					SC-CL	0.023	Type F	nt
					CL	0.027	Type D	nt
Pretty Plain (pp)	Group D	0.23	sporadic	9.66	ML	>0.064	Type D	J
					ML	0.074	Type D	E
					CL	>0.093	Type F	C
	Group B				SC	0.029	Type F	J
					MH	0.042	Type D	B
					CL	0.084	Type F	C
					SC	0.071	Type F	C
	Group D				SM	0.041	Type F	J
					SM	0.042	Type F	J
					SC	0.046	Type F	B
	Group B				SM	0.025	Type F	J
					SC	0.029	Type F	B
					SM	0.038	Type F	J

Table C3. Woodburn Soil Landscapes (continued)

Table 3 Woodburn Soil Landscapes									
Soil landscape	Soil hydrologic group	Percent area of high acid sulfate soil risk	Acid sulfate risk	Percent area of low acid sulfate soil risk*	USCS Class	K-factor USLE (t.ha.h/ha.MJ.mm)	Sediment type	Sediment basin wall construction (earth)	
					CL	0.041	Type F	A	
Romiaka (rm)	Group D	92.62	endemic	5.92	OL	0.025	Type D	J	
					CL	0.039	Type F	B	
	Group B				SM	0.040	Type F	I	
					PT	Peaty	Type D	J	
					CL	>0.073	Type F	J	
					SC	0.015	Type F	I	
					SC	0.034	Type F	I	
					SC	0.010	Type C	J	
					SM	0.008	Type C	I	
					SM	0.021	Type C	I	
					SC	0.032	Type C	I	
					SC	0.025	Type F	I	
	SC				0.034	Type F	I		
	SP-SC				0.002	Type C	I		
SC	0.010	Type C	I						
South Evans Head (se)		1.51	sporadic	11.61	PT	Peaty	Not tested	J	
	Group D				PT	Peaty	Type F	J	
					Group B	SM	Peaty	Type F	J
	Group C/D					SM	0.009	Type F	J
					PT	Peaty	Type F	J	
					PT	Peaty	Type F	J	
					ML	0.014	Type F	C	
	CH				0.019	Type F	H		
Sportsmans Creek (sp)	Group C/D	10.71	common	25.19	SM	0.032	Type F	J	
					SP-CL	0.019	Type F	VA	
					SC	0.021	Type F	B	
	Group B				SM	0.010	Type C	J	
					SM	0.013	Type C	I	
					SM	0.013	Type C	I	
SM	0.012	Type C	I						
Tabbimoble (tm)	Group C/D	0.00	sporadic	3.19	PT	Peaty	Type F	J	
					CL	0.029	Type D	A	
					CL	0.036	Type D	A	
					OL	>0.052	Type F	J	
					ML	>0.071	Type D	B	
					CL	0.047	Type D	D	
					CL	0.038	Type D	E	
					CL	0.033	Type D	E	
					Group C/D	OL	0.031	Type F	J
						ML	0.047	Type F	J
	ML					0.064	Type D	B	
	CL				0.042	Type D	D		

Table C3. Woodburn Soil Landscapes (continued)

Table 3 Woodburn Soil Landscapes								
Soil landscape	Soil hydrologic group	Percent area of high acid sulfate soil risk	Acid sulfate risk	Percent area of low acid sulfate soil risk*	USCS Class	K-factor USLE (t.ha.h/ha.MJ.mm)	Sediment type	Sediment basin wall construction (earth)
					CL	>0.095	Type F	C
					CL	0.089	Type F	C
					CL	0.025	Type D	B
					CH	0.017	Type D	H
					CH	0.018	Type F	H
	Group D				PT	Peaty	Type D	J
					CL	0.031	Type D	J
					CL	0.033	Type D	B
					CL	0.037	Type D	B
Weapons Range (wr)	Group A	0.39	sporadic	1.19	SM	0.004	Type C	I
					SM	0.007	Type C	I
					SP-SM	0.000	Type C	J
					SP-SM	0.000	Type C	J
					SP-SM	0.000	Type C	I
					SP-SM	0.000	Type C	J
					SM	0.002	Type C	I
					SM	0.017	Type F	J
					SM	0.007	Type C	I
					SP-SM	0.000	Type C	I
					SP-SM	0.000	Type C	I
					SP-SM	Pan	Type C	I
Disturbed Terrain (xx)	Group D	17.57	common	2.49	SM	0.002	Type C	J
					ML	0.062	Type F	J
					ML	0.066	Type F	E
					SP-ML	0.065	Type F	D

Table C4. Dorrigo Soil Landscapes

Table 4 Dorrigo Soil Landscapes						
Soil landscape	Soil hydrologic group	Acid sulfate risk	USCS class	K-factor USLE	Sediment type	Sediment basin wall construction (earth)
Arthurs Gap (ag)		none	SM-SC	0.010	Type F	I
			CL	0.018	Type D	B
			SC	0.040	Type F	B
Averys Creek (av)	Group C	none	OL	0.030	Type F	J
			ML	>0.094	Type F	C
			OL	0.032	Type F	J
			ML	0.053	Type D	B
			CL	>0.093	Type F	C
			CL	0.083	Type F	C
Bagawa (bw)	Group C/D	none	SW	0.014	Type F	J
			CL	0.030	Type D	B
			SC	0.025	Type F	B
			SC	0.032	Type F	B
			SC	0.023	Type F	C
Bellinger (be)	Group B	sporadic	ML	0.052	Type F	A
			ML	0.058	Type F	J
			ML	0.061	Type F	A
			ML	0.052	Type F	B
			ML	0.047	Type F	I
			OL	0.028	Type F	J
			ML-CL	0.050	Type F	B
SM	0.027	Type F	I			
Bielsdown (bi)	Group C	none	OL	0.023	Type F	J
			CL	0.058	Type F	C
			PT	Peaty	Type F	J
			ML-CL	0.032	Type F	C
Bostobrick (bk)	Group D	none	SC-CL	0.020	Type F	B/A
			SC	0.027	Type F	J
			CL	0.024	Type F	A
			OL	0.025	Type F	J
			SC	0.023	Type F	B
Black Mountain (bm)	Group B	none	ML	>0.056	Type D	B
			ML	0.052	Type D	B
			ML-CL	0.048	Type F	B
			ML	0.044	Type F	A
			ML-CL	0.047	Type D	D
Bobo (bo)	Group C/D	none	OL	Peaty	Type F	J
			SC	0.025	Type F	B
			CL	0.031	Type D	A
			ML	0.041	Type D	D
Bakers Plain (bp)	Group B/C	none	SC	0.031	Type F	B
			SC	0.018	Type F	C
			SC	0.025	Type F	B
			ML	0.022	Type F	A
			CL	0.022	Type F	C
Charlmont (ch)	Group B/C	endemic	OL	Peaty	Type F	J
			ML	>0.047	Type F	C
			ML	>0.087	Type F	C
			ML	0.054	Type F	A

Table C4. Dorrigo Soil Landscapes (continued)

Table 4 Dorrigo Soil Landscapes						
Soil landscape	Soil hydrologic group	Acid sulfate risk	USCS class	K-factor USLE	Sediment type	Sediment basin wall construction (earth)
Cloughers Creek (cg)	Group B/C	none	ML	0.052	Type F	I
			ML	0.058	Type D	E
			CL	0.036	Type D	E
	Group B		GM	0.007	Type F	J
			CL	0.037	Type D	B
			ML	0.052	Type D	D
			SC	0.043	Type D	D
Dairyville (da)	Group C	none	SM	0.021	Type F	J
			OL	0.039	Type F	J
			ML	0.039	Type F	A
			ML	0.023	Type F	A
Deadmans (de)	Group D	none	OL	0.027	Type D	J
			OL	0.017	Type D	J
			ML	0.045	Type D	D
			CL	0.032	Type D	D
Dangar Falls (df)	Group C/D	none	OL	0.019	Type F	J
			CH	0.051	Type F	C
			CL	0.038	Type F	C
			MH	0.027	Type D	B
Diehappy (di)	Group C/D	none	SM	0.035	Type F	J
			SM	0.051	Type D	J
			ML	0.061	Type D	D
Dorrigo (do)	Group C	none	OL	0.011	Type F	J
			GM	0.052	Type F	I
			CL	0.024	Type F	C
	Group C/D		CL	0.024	Type D	A
			MH-CH	>0.090	Type F	D
OL	0.016	Type F	J			
Dundurrabin (du)	Group D	none	SC-CL	0.019	Type F	B/A
			SC	0.027	Type F	B
			SC	0.015	Type F	B
			SC	0.055	Type F	C
Glenreagh (gl)	Group B	none	SM	0.015	Type F	J
			CH	0.020	Type D	A
			SM	0.033	Type D	J
	Group C/D		ML-CL	0.028	Type F	J
			CL	0.038	Type D	B
			CL	0.036	Type D	D
			CL	0.044	Type D	E
Gleniffer (gn)	Group B	sporadic none	CL	0.025	Type F	B
			CL	0.019	Type F	C
			CL	0.079	Type F	C
Gap Road (gp)	Group B	none	SP	0.004	Type C	J
			SC	0.004	Type F	I
			SC	0.002	Type C	I
			SP	0.010	Type C	I
			PT	Peaty	Type F	J
Kellys Creek (kc)	Group B	none	SC	0.035	Type F	I
			SC	0.028	Type F	B
			SM	0.016	Type F	J

Table C4. Dorrigo Soil Landscapes (continued)

Table 4 Dorrigo Soil Landscapes						
Soil landscape	Soil hydrologic group	Acid sulfate risk	USCS class	K-factor USLE	Sediment type	Sediment basin wall construction (earth)
Kooralbyn (ko)	Group C/D	none	OL	0.013	Type D	J
			ML	0.046	Type D	B
			ML-CL	0.044	Type D	D
			MH	0.042	Type D	D
			CL	>0.093	Type F	G
Kremnos (kr)	Group C/D	none	ML	0.036	Type D	B
			SC	0.010	Type F	B
			CL	0.084	Type F	C
			CL	0.050	Type F	B
			SP	0.016	Type F	J
			SP	0.000	Type C	I
Megan (me)	Group B	none	OL	>0.027	Type F	J
			ML	0.045	Type D	B
			ML	0.048	Type F	C
			ML	>0.090	Type F	C
			MH	>0.091	Type F	I
McGraths Hump (mg)	Group C/D	none	OL	0.010	Type F	J
			CL	0.022	Type F	A
			CL	>0.077	Type F	C
Never Never (nn)	Group B	none	ML	0.042	Type D	B
			OL	0.019	Type F	J
			CL	0.030	Type D	A
			CL	0.090	Type F	C
Nymboida Gorge (ny)	Group C/D	none	ML	0.051	Type D	D
			SC	0.043	Type D	D
			CH	0.022	Type D	D
			SM	0.044	Type D	J
Orara (or)	Group B	none	ML	0.041	Type F	A
			ML-CL	0.047	Type D	D
			ML	>0.090	Type F	C
			SC	0.000	Type C	I
Pine Creek (pn)	Group C	sporadic	OL	0.018	Type F	J
			CL	0.028	Type F	C
			OL	Peaty	Type F	J
			ML-CL	0.047	Type D	B
			MH	0.060	Type D	A
			SM	0.050	Type F	J
Promised Land (pl)	Group D	none	ML	>0.090	Type F	C
			ML	0.021	Type F	A
			CL	0.071	Type F	C
			ML	0.049	Type F	C
Paddys Plains (pp)	Group C	none	CL	0.014	Type F	C
			CH	0.058	Type F	C
			OL	0.011	Type F	J
	Group B		OL	0.016	Type F	J
			CL	0.042	Type F	C
Rocky Creek (rc)	Group C/D	none	OL	0.004	Type F	J
			CL	0.025	Type F	C

Table C4. Dorrigo Soil Landscapes (continued)

Table 4 Dorrigo Soil Landscapes						
Soil landscape	Soil hydrologic group	Acid sulfate risk	USCS class	K-factor USLE	Sediment type	Sediment basin wall construction (earth)
Sherwood (sh)	Group C	none	SM	0.042	Type F	I
			SC	0.024	Type F	I
			SC	0.038	Type F	I
Suicide (su)	Group B	none	OL	0.023	Type F	J
			ML	0.041	Type F	A
			ML	>0.086	Type F	C
			ML	>0.091	Type F	D
Tallawudjah (tw)	Group C	none	CL	0.074	Type F	C
			ML	>0.058	Type D	J
			ML	>0.064	Type D	J
			ML	0.050	Type D	B
Towallum (to)	Group C/D	none	CL	0.029	Type D	A
	Group D		ML	0.067	Type D	I
			CL	0.039	Type D	E
			CL	0.058	Type F	B
Timber Top (tt)	Group C	none	SM	0.023	Type F	J
			SC	0.038	Type F	B
			CL	0.027	Type F	A
			SC	0.006	Type F	C
			ML	0.049	Type F	A
			ML	0.056	Type F	A
Ulong (ul)	Group B	none	OL	0.016	Type F	J
			CL	0.033	Type F	C
			CL	>0.086	Type F	C
			ML	0.046	Type F	A
Valery (va)	Group C/D	none	OL	0.019	Type F	J
			CL	0.082	Type F	C
			CL	0.083	Type F	C
			SM	0.044	Type F	J
			SM	0.039	Type C	J
Walters Creek (wc)	Group B	none	SP	0.007	Type C	I
			SP	0.010	Type C	J
			SC	0.000	Type C	I
	Group C/D		SW	0.019	Type C	I
			CL	0.020	Type F	A
			SC	0.018	Type F	C

Table C5. Coffs Harbour Soil Landscapes

Table 5 Coffs Harbour Soil Landscapes							
Soil landscape	Soil hydrologic group	Percent area of high acid sulfate soil risk	Acid sulfate risk	USCS class	K-factor	Sediment type	Sediment basin wall construction (earth)
Arthurs Gap (ag)	Group D	0.00	none	SW	0.007	Type C	J
				SC	0.013	Type F	J
				ML	0.067	Type F	A
Barcoongere (bc)	Group B	2.16	sporadic	CL	0.031	Type F	J
				CL	0.037	Type F	A
				CH	>0.086	Type F	C
				CH	0.055	Type F	C
				CL	0.026	Type D	A
Bundagen (bd)	Group B	0.63	endemic	SM	0.019	Type D	J
				SP	0.000	Type C	J
				PT	Peaty	Type F	J
Bobo (bo)	Group D	0.00	none	CL	>0.028	Type F	B
				CL	>0.061	Type D	D
				CL	0.056	Type D	nt
Bucca (bu)	Group C	0.00	none	ML	Peaty	Type F	A
				CL	0.032	Type F	A
	Group B			ML	0.044	Type F	C
				SM-ML	>0.077	Type F	I
Bagawa (bw)	Group C	0.00	none	SM	0.022	Type F	J
				SC	0.032	Type D	D
				CL	0.011	Type D	A
	Group C/D			SM	0.027	Type F	I
				CH	0.029	Type D	B
				CL	0.030	Type D	A
Charlmont (ch)	Group B	91.75	endemic	OL	Peaty	Type F	J
				ML	>0.047	Type F	C
				ML	>0.087	Type F	C
	Group D			ML	0.054	Type F	A
Dairyville (da)	Group B	0.75	sporadic	ML	0.040	Type F	A
				ML	0.055	Type F	A
	Group B			ML	>0.052	Type D	A
				ML	>0.063	Type D	A
Glenreagh (gl)	Group C	0.00	none	CL	0.056	Type D	D
				CL	0.054	Type D	B
				CL	0.035	Type F	C
				SW	0.022	Type F	J
	Group C/D			SC	0.050	Type F	B
				SC	0.036	Type D	D
				CL	0.028	Type D	B
Gap Road (gp)	Group B	0.00	none	SC	0.004	Type F	I
				SC	0.002	Type C	I
				SP	0.010	Type C	I
Kremnos (kr)	Group C/D	0.00	none	ML	0.036	Type D	B
				SC	0.010	Type F	B
				CL	0.084	Type F	C
				CL	0.050	Type F	B
				SP	0.016	Type F	J
				SP	0.000	Type C	I
Look-At-Me-Now (lo)	Group B-D	1.85	sporadic	SM	0.033	Type F	J
					0.030	Type C	J

Table C5. Coffs Harbour Soil Landscapes (continued)

Table 5 Coffs Harbour Soil Landscapes							
Soil landscape	Soil hydrologic group	Percent area of high acid sulfate soil risk	Acid sulfate risk	USCS class	K-factor	Sediment type	Sediment basin wall construction (earth)
				SC	0.017	Type F	B
Moonee (mo)	Group D	2.56	sporadic	ML	0.053	Type F	A
				ML	>0.079	Type D	nt
				GP	0.023	Type F	I
Newry (ne)	Group C/D	1.06	sporadic	PT	Peaty	Type F	J
				ML	0.032	Type D	J
				ML	>0.081	Type F	D
				OL	0.035	Type D	J
Newports Creek (np)	inapplicable	46.09	endemic	CL	>0.086	Type F	C
OL				CL	Peaty	Type F	J
				CL	0.034	Type D	B
Orara (or)	Group B/C	0.00	none	ML	0.060	Type F	nt
				OL	0.026	Type D	J
				OL	0.052	Type D	J
				ML	0.035	Type F	A
Pine Creek (pn)	Group C	0.60	sporadic	CL-CH	0.037	Type F	nt
Raleigh (ra)	Group B	94.73	endemic	ML	>0.065	Type D	I
				CL	>0.063	Type D	nt
				ML	>0.063	Type D	B
	Group C			CL	0.059	Type D	nt
				SW	0.017	Type F	I
Red Range (re)	Group B	0.00	none	SM-ML	0.039	Type F	B&I/A
				SW	0.024	Type F	I
				SC	0.025	Type F	C
				GP	0.040	Type C	J
				SC	0.024	Type F	B
Goolawah (go)	Group A	3.80	sporadic	SP	0.016	Type C	nt
				SP	0.023	Type C	nt
Sherwood Creek (sc)	Group A	0.00	none	OL	0.016	Type F	J
				SW	0.015	Type F	I
Sherwood (sh)		0.00	none	PT	Peaty	DP not tested	J
				SM	Peaty	Type F	I
				SM	0.039	Type F	I
				SM	0.042	Type F	I
	Group C/D			SC	0.024	Type F	I
				SC	0.038	Type F	I
Suicide (su)	Group B	0.00	none	OL	0.025	Type F	J
				ML	0.024	Type F	A
				CL	0.037	Type F	B
				CL	0.037	Type F	B
Toormina (tm)	Group D	75.75	endemic	PT	Peaty	Type F	J
				OL	>0.020	Type F	J
				SM-ML	0.077	Type F	D
				SM	0.040	Type F	J
				PT	Peaty	Type F	J
				ML	0.053	Type D	B
Tallawudjah (tw)	Group C	0.00	sporadic	ML-CL	0.026	Type D	J
				CL-SC	0.045	Type F	nt

Table C5. Coffs Harbour Soil Landscapes (continued)

Table 5 Coffs Harbour Soil Landscapes							
Soil landscape	Soil hydrologic group	Percent area of high acid sulfate soil risk	Acid sulfate risk	USCS class	K-factor	Sediment type	Sediment basin wall construction (earth)
Ulong (ul)	Group C	0.22	sporadic	CL	0.029	Type D	A
				CL	0.032	Type D	A
				CL	0.032	Type F	C
				ML	>0.038	Type F	J
				ML	0.040	Type D	A
				CL	0.024	Type F	C
	Group B/C	CL	0.082	Type F	C		
		OL	0.017	Type F	J		
		CL	0.052	Type F	C		
		CL	0.073	Type F	C		
		CL	0.079	Type F	C		
		CL	0.085	Type F	C		
		ML	0.050	Type D	A		
Walters Creek (wc)	Group D	0.00	none	SM	0.008	Type F	B&I
				SM	0.011	Type F	I
				SC	0.032	Type F	C
	Group C/D	SM	0.012	Type F	B&I		
		CL	0.025	Type F	A		
		CL	0.014	Type F	A		
		CL	0.024	Type F	A		
		SC-CL	0.055	Type F	C		
	Group C/D	CH	0.015	Type D	G		
		CL	0.034	Type D	D		
		SC	0.027	Type C	I		
		CH	0.018	Type D	G		
		CL	0.019	Type D	A		

Table C6. Macksville Soil Landscapes

Table 6 Macksville Soil Landscapes							
Soil landscape	Soil hydrologic group	Percent area of high acid sulfate soil risk	Acid sulfate risk	USCS Class	K-factor USLE	Sediment type	Sediment basin wall construction (earth)
Austral Eden (ae)	Group B	99.33	endemic	ML	0.055	Type F	I
				ML	0.065	Type F	A
	Group D			OL	>0.019	Type F	J
				MH	0.048	Type D	A
				ML	0.080	Type D	I
Aldavilla (al)	Group C	0.00	none	ML	0.046	Type D	J
				ML	0.058	Type D	B
				SM-ML	0.042	Type D	J/B
	Group C/D			ML	0.049	Type F	B
				CH	0.016	Type D	A
				CH	0.021	Type D	B
				ML	Pan	Type F	A
	Group C/D			ML	Pan	Type F	B
				ML	0.042	Type F	J
				ML	0.046	Type D	B
				CL	0.037	Type F	A
				CL	0.087	Type F	C
Bowra Creek (ba)	Group D	0.97	sporadic	OL	0.050	Type F	J
				ML	0.060	Type F	A
				ML	0.056	Type D	B
				ML	0.058	Type F	C
	Group C			OL	>0.033	Type F	J
				ML	>0.059	Type D	B
				CL	0.047	Type D	B
	inapplicable			OL	0.028	Type F	J
				ML	0.056	Type D	B
Belgrave Falls (bf)	Group B	0.00	none	SM	0.022	Type F	I
				SM	0.056	Type F	I
	Group A/B			SM	0.019	Type F	I
				SM	0.019	Type F	I
Broads Mountain (br)	Group C/D	0.00	none	SM	0.047	Type F	J
				SM	0.063	Type F	J
				SM-ML	0.063	Type D	D
				SM	Peaty	Type F	J
				SM	0.036	Type F	D
				GM	0.059	Type C	J
Big Smoky (bs)	Group B	0.06	sporadic	SM	0.026	Type F	J
				SM	0.034	Type F	J
				CL	>0.089	Type F	G
				CL	>0.091	Type F	D
	Group B			SM	0.017	Type F	J
				SC	0.029	Type F	B
				CL	0.044	Type F	C
				CL	0.057	Type F	G
	Group D			SW	0.007	Type F	J
				SP	0.031	Type F	I
	Group D			SM	Peaty	Type F	J
				ML	0.038	Type F	C
				CL	0.045	Type F	C
Cairncross (ca)	Group C/D	3.70	common	ML	0.043	Type F	A
				CL	0.024	Type D	G
				CL	0.044	Type F	B
				CL	>0.091	Type F	H
	Group C/D			OL	0.017	Type F	J
				CH	0.036	Type D	A

Table C6. Macksville Soil Landscapes (continued)

Table 6 Macksville Soil Landscapes								
Soil landscape	Soil hydrologic group	Percent area of high acid sulfate soil risk	Acid sulfate risk	USCS Class	K-factor USLE	Sediment type	Sediment basin wall construction (earth)	
				CH	0.034	Type F	A	
Clybucca (cy)	Group C/D	38.73	endemic	OL	Peaty	Type F	J	
					0.034	Type F	nt	
					0.023	Type F	nt	
				OL	Peaty	Type F	J	
				CL	0.042	Type D	B	
				PT	Peaty	Type F	J	
				OL	0.023	Type F	J	
				SM	0.040	Type F	I	
			SM	0.044	Type F	I		
Diehappy (di)	Group C	0.15	sporadic	OL	Peaty	Type F	J	
					ML	0.048	Type D	B
					ML	0.053	Type D	D
	Group C			SM-ML	0.019	Type F	B&I/A	
				SM	0.028	Type F	B&I	
	Group D			SM	0.045	Type F	D	
				SM	0.050	Type F	J	
Euroka (eu)	Group C	0.01	sporadic	OL	0.027	Type F	J	
					SM-ML	0.043	Type D	D
					GC	0.050	Type C	E
	Group C			SM	0.026	Type F	J	
				SM	0.038	Type D	J	
				CL	0.017	Type D	B	
				CL	0.019	Type D	D	
Goolawah (go)	Group A	1.15	sporadic	SP	0.007	Type C	I	
				SP	0.000	Type C	I	
				SP	0.013	Type C	J	
				SP	0.010	Type C	J	
Hat Head (hh)	Group B/C	4.62	sporadic	SM	Peaty	Type C	J	
				SP	0.000	Type C	I	
				PT	Peaty		J	
				PT	Peaty	Type F	J	
	Group B/C			SP	0.007	Type F	J	
				SP	0.010	Type C	J	
				SM	Pan	Type F	J	
Huntingdon (hn)	Group B/C	0.00	none	SM	0.031	Type F	J	
				ML	0.056	Type D	B	
				SM	0.049	Type F	J	
Kundabung (kg)	Group C	0.28	sporadic	ML	0.050	Type D	D	
					CH	0.022	Type D	G
					CL	>0.090	Type F	C
	Group C			OL	0.037	Type F	J	
				ML	0.055	Type D	A	
				CL	0.032	Type D	G	
				CL	0.042	Type D	B	
Killick (ki)	Group A	0.15	sporadic	SP	0.000	Type C	J	
				SP	0.000	Type C	I	
Killiekrankie (kk)	Group C/D	0.00	none	PT	Peaty	Type F	J	
				OL	0.014	Type D	J	
				ML	0.033	Type F	C	
				SM	0.025	Type F	K	

Table C6. Macksville Soil Landscapes (continued)

Table 6 Macksville Soil Landscapes							
Soil landscape	Soil hydrologic group	Percent area of high acid sulfate soil risk	Acid sulfate risk	USCS Class	K-factor USLE	Sediment type	Sediment basin wall construction (earth)
Macleay Arm (ma)	Group D	57.26	endemic	PT	Peaty	Type F	J
				PT	Peaty	Type F	J
	Group A/B			PT	Peaty	Type F	J
				SP	0.016	Type C	J
Mistake (mk)	Group C	0.00	none	OL	0.010	Type F	J
				ML	0.050	Type D	B
	Group C			ML	0.021	Type F	A
				CL	0.032	Type D	A
				CL	0.031	Type D	A
	Group B			OL	0.020	Type F	J
				CL	0.040	Type F	A
Maria River (mr)	Group B	96.79	endemic	ML	>0.047	Type F	A
				CL	>0.089	Type F	C
				ML	0.065	Type D	B
	Group C			OL	>0.034	Type D	J
				ML	0.052	Type D	D
				CL	0.054	Type D	D
	Group C			OL	0.027	Type F	J
				CL	0.038	Type D	D
				ML	0.061	Type D	D
Mungay Mountain (mu)	Group D	0.00	none	SP	0.046	Type F	J
	Group B			GP	0.023	Type C	J
				GP	0.041	Type C	J
				SC	0.054	Type D	D
Newry (ne)	Groupo C/D	1.35	sporadic	SM	Peaty	Type F	J
				SM	0.030	Type F	J
				SC	0.034	Type C	B
	Group C			OL	0.044	Type F	J
				ML	0.066	Type F	A
				CL	>0.095	Type F	C
				CL	>0.095	Type F	C
	Groupo C/D			ML	0.043	Type F	I
				MH	>0.075	Type D	A
				ML	0.074	Type F	D
Nambucca River (nr)	Group C	0.25	sporadic	SM	0.017	Type F	I
				SM	0.033	Type F	I
				OL	0.028	Type F	J
	Group B/C			SM-ML	0.042	Type F	I
				ML	0.067	Type F	I
	Group B			ML	0.063	Type F	B
				ML	0.068	Type D	D
				ML	>0.094	Type F	D
Pine Creek (pn)	Group B	0.06	sporadic	SM	0.040	Type F	J
				CL	>0.083	Type F	C
	Group C/D			GM	0.018	Type C	J
				ML	0.046	Type F	A
				ML	0.052	Type F	D
	Group C/D			OL	0.029	Type F	J
				CL	0.031	Type D	D
	Group C/D			SM	0.020	Type F	I
				SM	0.031	Type C	J
	Raleigh (ra)			Group C/D	64.76	widespread	OL
MH		0.056	Type D				B
ML		0.070	Type D				B

Table C6. Macksville Soil Landscapes (continued)

Table 6 Macksville Soil Landscapes							
Soil landscape	Soil hydrologic group	Percent area of high acid sulfate soil risk	Acid sulfate risk	USCS Class	K-factor USLE	Sediment type	Sediment basin wall construction (earth)
Roses Knob (rk)	Group C	0.09	sporadic	ML	>0.062	Type F	I
				ML	0.074	Type F	B
				ML	0.073	Type D	D
	Group D			SM	0.048	Type F	J
				SM	0.019	Type F	J
	Group C			GC	0.029	Type D	D
				OL	0.027	Type D	J
				ML	0.040	Type D	D
				CL	0.043	Type D	B
OL		0.025	Type F	J			
Rosewood Road (rw)	Group B/C	0.10	sporadic	ML	0.054	Type D	A
				CH	0.075	Type F	C
				OL	0.025	Type F	J
	Group B/C			ML	0.053	Type F	B
				CL	>0.085	Type F	C
				PT	Peaty	Type F	J
Seven Oaks (se)	inapplicable	90.16	endemic	ML	0.044	Type D	A
				CL	0.047	Type D	B
				ML	Peaty	Type F	B
				PT	Peaty	Type F	J
				PT	Peaty	Type F	J
				MH	>0.087	Type F	D
				ML	>0.085	Type F	D
				ML	Peaty	Type D	J
				ML	0.051	Type D	B
				SM	0.024	Type F	B&I
				ML	0.075	Type F	A
				Snowy Range (sn)	Group D	0.00	none
CL	0.082	Type F	C				
Group D Group C/D	SM	Peaty	Type F		I		
	PT	Peaty	Type D		J		
	ML	0.064	Type D		D		
Stuarts Point (sp)	Group A	4.75	endemic	SP	0.005	Type C	J
				SP	0.000	Type C	J
				SP	Pan	Type C	I
Tamban (tb)	Group C/D	0.00	none	OL	0.041	Type F	J
				SM	0.055	Type F	J
	Group C			ML	0.031	Type F	J
				CL	0.033	Type D	B
				CL	0.020	Type D	B
	Group D			ML	0.066	Type D	E
				ML	0.058	Type D	D
				SM-OL	0.028	Type D	J
SM	0.041	Type D	J				
Thumbs Creek (tc)	inapplicable	0.00	none	SM	0.019	Type F	J
				SM-ML	0.019	Type F	B&I/A
				GP-GM	0.007	Type C	I
				OL	0.035	Type F	J
Temagog (tg)	Group C	0.00	none	GM	0.048	Type F	J
				GM	0.054	Type D	J
				GC	0.031	Type C	B
Toormina (tm)	inapplicable	93.05	endemic	PT	Peaty	Type F	J
				SM	0.030	Type F	I

Table C6. Macksville Soil Landscapes (continued)

Table 6 Macksville Soil Landscapes							
Soil landscape	Soil hydrologic group	Percent area of high acid sulfate soil risk	Acid sulfate risk	USCS Class	K-factor USLE	Sediment type	Sediment basin wall construction (earth)
				SM	0.048	Type F	I
				SM	0.034	Type F	J
				SP	0.012	Type C	I
				OL	0.036	Type F	J
				ML	Peaty	Type F	J
				ML	0.038	Type F	A
				CL	0.033	Type D	B
Valla (vl)	Group B	0.56	sporadic	SM	0.016	Type F	J
				SC-CL	0.020	Type F	C
				CL	0.073	Type F	G
				CL	0.089	Type F	G
Warrell Creek (wa)	Group B	0.14	sporadic	OL	0.034	Type F	J
				CL	0.072	Type F	C
				CL	0.041	Type F	C
	Group C			OL	0.014	Type F	J
				CL	0.030	Type D	A
				CL	>0.088	Type F	C
				ML	>0.092	Type F	I
	Group B			OL	0.017	Type F	J
				CL	0.078	Type F	C
				ML	>0.087	Type F	C
	Group D			OL	0.032	Type F	J
				ML	0.059	Type D	D
				CL	>0.089	Type F	C
				CL	>0.091	Type F	C
Welshes Creek (we)	Group C	0.00	none	ML	0.020	Type F	A
				CL	0.021	Type D	A
	Group C			SM	0.013	Type F	J
				GM	0.026	Type F	B&I
				CH	0.018	Type D	G
	Group C			ML	0.033	Type F	C
				ML	0.036	Type F	D
				SM	0.027	Type F	B&I
Way Way (ww)	Group C/D	0.00	sporadic	ML	Peaty	Type F	J
				ML	0.047	Type D	B
				CL	>0.088	Type F	C
	Group D			SM-ML	0.024	Type F	J
	Group B			OL	0.028	Type F	J
				ML	0.060	Type F	C
				ML	0.038	Type F	A
	Group C/D			OL	0.022	Type F	J
				ML	0.057	Type D	D
				ML	0.046	Type D	B
Yarrahapinni (ya)	Group C	0.00	none	OL	0.019	Type F	J
				ML	0.038	Type F	A
				CL	0.039	Type F	C

Soil landscape	Common constraints	Slope range (%)	Soil hydrologic group	Acid sulfate risk	USCS class	K-factor USLE	Sediment type	Sediment basin wall construction (earth)
Battery Hill (bh)	generally high erosion hazards; some steep slopes; shallow soils and rock outcrop common; some localised aquifer re-charge areas; widespread risks to foundations	10 to 50	Group D	none	ML SM ML CH CL	0.013 0.046 0.022 0.035 0.043	Type F Type F Type F Type D Type D	J I A H B
Black Jack (bj)	large aquifer re-charge area; localised areas of high erosion hazard, shallow soils and rock outcrop; widespread risks to foundations	4 to 7	Group D Group C Group B/C	none	ML CL CH ML CL CH CH	0.033 0.019 0.015 0.034 0.025 0.018 0.020	Type F Type D Type F Type F Type D Type F Type F	J K J A H H H
Booloocoroo (bo)	generally high erosion hazards; high run-on, instances high waterables seasonal waterlogging, flooding in low areas; widespread risks to foundations; localised mine subsidence	0 to 3	Group C	none	SC ML-CL ML-CL CH CH CH SC-CL SC-MIL CL SC-CL CH	0.016 0.050 0.024 0.024 0.023 0.028 0.037 0.050 0.031 0.043 0.025	Type F Type F Type F Type D Type F Type F Type F Type F Type D Type D Type D	I J J F H G B/A I A B F
Carroll Creek (ca)	high erosion hazards; high run-on, widespread flooding in low areas; frequent high waterables and waterlogging; aquifer re-charge areas and localised salinity; widespread risks to foundations	<1	Group D Group C	none	CL-MH CL CL CH CH	0.023 0.035 0.042 0.029 0.019	Type D Type D Type D Type D Type D	J J D G&F G&F
Conadilly (cd)	generally high erosion hazards; high run-on, seasonal waterlogging and flooding of low areas; some permanently high waterables; localised aquifer re-charge, widespread salinity hazard; widespread risks to foundations	<0.5	Group C/D Group C/D	none	OH CH OH CH CH CH CH CH CH	0.010 Peaty Peaty 0.008 0.015 0.017 0.028 0.016	Type D Type F Type D Type D Type D Type D Type D Type D Type D	J J J J J F E F

Table C7. Curlewis Soil Landscapes (continued)

Soil landscape	Common constraints	Slope range (%)	Soil hydrologic group	Acid sulfate risk	USCS class	K-factor USLE	Sediment type	Sediment basin wall construction (earth)
Carinya (cr)	generally high erosion hazards; large aquifer re-charge area; shallow soils and rock outcrop in upslope areas; high run-on in low areas; localised risks to foundations	3 to 10	Group C	none	CL	0.027	Type F	J
					CL	0.031	Type F	J
					CL	0.036	Type D	B
					CH	0.019	Type D	F
Curlewis Swamp (cu)	generally high run-on; widespread risks to foundations	<1	Group D	none	CL	0.022	Type F	J
					CH	0.021	Type D	H
					CH	0.029	Type F	H
Dead Horse (dh)	high run-on and aquifer re-charge area; generally high erosion hazards; localised high waterlogging; seasonal waterlogging and flooding of low areas; some dryland salinity; localised risks to foundations	<3	Group C	none	ML-CL	0.038	Type F	J
					SM	0.055	Type D	J
			Group C/D		ML-CL	0.049	Type D	J
					CL	0.035	Type D	J
					CL	0.027	Type F	G
					CH	0.032	Type D	F
East Lynne (el)	generally steep slopes and high erosion hazards; widespread mass movement and rock fall; widespread distribution of non	32 to 56	Group D	none	SC	0.014	Type F	J
					SC-ML	0.013	Type F	J
Fullwoods Road (fr)	generally high water erosion hazards; high run-on and permanently high waterlogging in low areas; localised aquifer re-charge and saline areas; localised wind erosion hazard; localised risks to foundations	2 to 8	Group B/C Group C	none	ML	0.050	Type F	J
					CL	0.033	Type D	J
					SC-CL	0.051	Type D	D
					CL	0.035	Type D	B
					SC	>0.098	Type F	C
					CL	0.024	Type D	G
					CL	0.021	Type F	G
Green Island (gi)	non cohesive soils subject to high wind and wave erosion hazards; some permanently high waterlogging and flooding in low areas; localised non cohesive materials; areas of aquifer re-charge;	<3	Group C	none	SW	Peaty	Type F	J
					SP	0.011	Type C	J
					CL	0.022	Type D	H
Goran Lake (gl)	generally low lying area subject to high run-on, permanently high waterlogging and flooding; very high water and wave erosion hazards; widespread aquifer re-charge and salinity; widespread risks to foundations	0	Group C	none	CH	0.015	Type D	J
					CH	0.015	Type D	G&F
					CH	0.021	Type D	H&F
Goscombes Road (go)	generally high erosion hazards; high run-on and seasonal waterlogging of low areas; localised flooding and perma_nently high waterlogging	1 to 5	Group C	none	ML	0.034	Type F	J
					ML	0.034	Type F	I
					SM	0.051	Type F	J

Table C7. Curlewis Soil Landscapes (continued)

Soil landscape	Common constraints	Slope range (%)	Soil hydrologic group	Acid sulfate risk	USCS class	K-factor USLE	Sediment type	Sediment basin wall construction (earth)
Hartfell (ha)	generally high erosion hazards; localised steep slopes, widespread shallow soils and rock outcrops; areas of high wind erosion; high run-on to some low areas; widespread risks to foundations	8 to 20	Group D Group B/C	none	CL ML-CL ML SM-SC CL	0.023 0.049 0.047 0.054 0.059	Type D Type F Type F Type F Type F	G J A I I
Kilphysics Road (kr)	generally high erosion hazards; localised shallow soils and rock outcrop; high run-on to low areas; widespread aquifer re-charge; permanently high waterables and seasonal waterlogging in some low areas; instances of dryland salinity; widespread risks to foundations	2 to 8	Group B/C Group C	none	ML SM-ML ML CL CL	0.014 0.042 0.039 0.025 0.028	Type F Type F Type F Type F Type D	A J D G G
Lever Gully (lg)	generally high erosion hazards; large areas of high run-on and aquifer re-charge; localised flooding and high waterable hazards; instances of salinity; widespread risks to foundations	2 to 10	Group C Group B/C	none	CH CH CH CH CL CH CL ML-CL	0.026 0.010 0.024 0.022 0.040 0.023 0.038 0.041	Type D Type D Type F Type D Type F Type D Type F Type F Type F	J J H F J H G B
Long Mountain (lm)	generally high erosion hazards; localised waterlogging and aquifer recharge in low lying areas; shallow non cohesive soils and rock outcrop in upslope areas; localised risks to foundations	2 to 12	Group C Group D Group C	none	CL ML ML CL CH SC ML CL CH	0.032 0.020 0.050 0.015 0.020 0.032 0.048 0.032 0.021	Type F Type F Type F Type F Type D Type F Type F Type D Type D	J A J J H B A B H
Lochaber (lo)	generally low lying areas with high run-on, permanently high waterables and localised seasonal waterlogging; large areas of aquifer re-charge and salinity; widespread wind erosion and localised wave erosion; some shallow soils. widespread risks to foundations	1 to 20	Group C Group C	none	CL CH CH CH	0.002 0.009 0.015 0.012	Type D Type F Type D Type D	G H H G&F
Leslies Road (lr)	generally low lying area with high erosion hazards; high run-	<2	Group D	none	CH	Peaty	Type D	J

Table C7. Curlewis Soil Landscapes (continued)

Soil landscape	Common constraints	Slope range (%)	Soil hydrologic group	Acid sulfate risk	USCS class	K-factor USLE	Sediment type	Sediment basin wall construction (earth)
	on, permanently high waterables, waterlogging in low areas; widespread aquifer re-charge and salinity hazard; wide_spread risks to foundations		Group C/D		CH	0.016	Type D	J
					CH	0.024	Type F	H
					CH	0.022	Type D	F
					CH	0.029	Type F	H
					CH	0.025	Type D	H
Maryland (ma)	generally high erosion hazards; large low lying areas with high run-on; large aquifer re-charge areas; high waterables and localised flooding in some low areas; widespread risks to foundations	1 to 10	Group B/C Group B/C	none	CH	0.024	Type F	G
					CL	0.033	Type F	A
					CH	0.026	Type D	F
					CH	0.025	Type D	F
					SM	0.069	Type F	J
Mecathloan Downs (md)	large areas of high run-on, aquifer re-charge and dryland salinity; localised waterlogging; widespread wind erosion; localised risks to foundations	2 to 8	Group C	none	ML	0.040	Type F	A
					CL	0.037	Type F	A
					CL	0.009	Type F	G
Mount Milbullia (mm)	generally high erosion hazards steep slopes, shallow soils and rock outcrops; widespread rock falls; localised risks to foundations	10 to 85	Group D	none	SC	Peaty	Type F	J
					SM-SC	0.026	Type F	J
					CH	0.029	Type D	J
Mooki River (mo)	generally high erosion hazards; low lying areas subject to high run-on, seasonal waterlogging and flooding; widespread risks to foundations	<15	Group C	none	CL	0.025	Type D	G
					CH	0.030	Type F	H
					SC	0.010	Type C	B
					CL	0.021	Type F	A
Mount Tamarang (mt)	generally high erosion hazards steep slopes, shallow soils and rock outcrops; widespread mass movement hazard; widespread risks to foundations	10 to 80	Group B/C Group B	none	ML	Peaty	Type F	J
					CL	0.009	Type D	J
					CL	0.031	Type F	A
					CL	0.041	Type F	B
					ML-CL	0.055	Type F	B
					SC	0.037	Type F	K
Mount Wilga (mw)	generally steep slopes and high erosion hazards; widespread mass movement and rock fall; localised distribution of non cohesive soils and large aquifer re-charge areas; shallow soils and rock outcrop upslope; widespread risks to foundations	25 to >100	Group C Group B	none	SC-ML	0.024	Type F	B/A
					CL	0.011	Type F	J
					ML-CL	0.035	Type F	B
					CH	0.018	Type F	G
Noojee (nj)	generally high erosion hazards; large areas of high run-on and aquifer re-charge; widespread salinity; permanently high waterables and seasonal waterlogging in some low areas;	<8	Group C/D Group C	none	ML-CL	0.022	Type F	J
					CH	0.018	Type D	J
					CH	0.019	Type D	H

Table C7. Curlewis Soil Landscapes (continued)

Table 7 Curlewis Soil Landscapes									
Soil landscape	Common constraints	Slope range (%)	Soil hydrologic group	Acid sulfate risk	USCS class	K-factor USLE	Sediment type	Sediment basin wall construction (earth)	
	instances of wind erosion; widespread risks to foundations		Group D		SC	0.039	Type F	J	
					CH	0.023	Type D	F	
					CH	0.018	Type F	H	
					SC	0.036	Type F	A	
Pit Hill (ph)	generally steep slopes and high erosion hazards; widespread mass movement and rock fall; localised distribution of aquifer re-charge areas; shallow soils and rock outcrop upslope; widespread risks to foundations	15 to 80	Group B/C	none	ML	0.019	Type F	A	
					CH	0.037	Type F	C	
					SW	0.037	Type F	J	
Ponderosa (pn)	generally high run-on to low areas; widespread aquifer re-charge and dryland salinity; some instances of permanently high waterables and seasonal waterlogging; widespread risks to foundations; localised instances of mine subsidence	2 to 8	Group C Group B	none	CH	0.017	Type D	G	
					CH	0.013	Type D	J	
					CH	0.022	Type F	G	
					CH	0.020	Type D	G	
					CH	0.024	Type F	G	
					CH	>0.090	Type F	H	
Porcupine (po)	generally high erosion hazards; widespread shallow soils and rock outcrops; instances of non cohesive soils and wind erosion hazards; areas of aquifer re-charge; localised risks to foundations	2 to 12	Group B	none	ML	0.034	Type F	J	
					SM-SC	0.027	Type F	I	
					SC	0.018	Type D	A	
					CH	0.011	Type F	H	
Quirindi Creek (qc)	generally high erosion hazards; large, low lying areas of high run-on and aquifer re-charge; widespread flooding hazard; localised salinity; widespread risks to foundations	<1	Group C Group C/D	none	ML	0.029	Type F	J	
					ML	0.030	Type F	B	
					CL	0.024	Type D	D	
					CH	0.013	Type D	D	
					CL	0.027	Type D	D	
					CH	>0.098	Type F	H	
					CL	0.019	Type D	G	
Stafford Gap (sg)	wind and water erosion hazards generally high; large areas of aquifer re-charge and localised salinity; high run-on permanently high waterables, seasonal waterlogging in some low areas; instances of mine subsidence	3 to 20	Group C Group C/D Group D	none	SC	0.033	Type F	J	
					SC-ML	0.029	Type F	I	
					ML	0.021	Type F	J	
					SC	0.018	Type F	B	
					SC	0.053	Type F	I	
					SC	0.025	Type F	C	
					SC	0.024	Type F	I	
					SC	0.042	Type F	B	
					CL	0.026	Type D	D	

Table C7. Curlewis Soil Landscapes (continued)

Soil landscape	Common constraints	Slope range (%)	Soil hydrologic group	Acid sulfate risk	USCS class	K-factor USLE	Sediment type	Sediment basin wall construction (earth)					
Tally Ho (ta)	generally high erosion hazards; shallow soils and rock outcrop upslope; localised areas of high run-on, permanently high watertables and aquifer recharge; instances of non cohesive soils; widespread risks to foundations	2 to 8	Group D Group B/C Group C	none	ML	Peaty	Type F	J					
					ML	0.015	Type F	A					
					CL	0.021	Type F	J					
					CH	0.021	Type D	H					
					CH	0.020	Type D	H					
					CH	0.024	Type D	J					
					CH	0.020	Type D	H					
					CH	0.016	Type D	H					
					SC-CL	0.028	Type D	G					
					Trinke Forest (tf)	generally high erosion hazards; high run-on to low areas widespread dryland salinity hazard; permanently high watertables and seasonal waterlogging in some low areas;	<5	Group C/D Group B/C	none	SW	0.032	Type F	J
SC-ML	0.031	Type F	B										
SC-ML	0.029	Type F	I										
SC	0.029	Type D	D										
CL	0.023	Type F	G										
CH	0.018	Type F	G										
Turkey Range (tu)	generally high water and wind erosion hazards; areas of shallow soils and rock outcrop upslope; localised areas of non cohesive soils;	2 to 20	Group D Group B/C Group D	none						SP	0.013	Type F	J
										SC-CL	0.017	Type F	J
										CL	0.034	Type F	J
										SP	0.004	Type C	I
					GC	0.032	Type C	I					
					CH	0.020	Type D	H					
					Watermark (wa)	broad aquifer re-charge area; some steep slopes and shallow soils; high run-on to some low areas; localised areas of non cohesive soils and wind erosion hazard; localised risks to foundations; localised mine subsidence	2 to 15	Group B Group D Group C	none	ML	0.010	Type F	J
										SC	0.016	Type C	I
										ML	Peaty	Type F	J
										CH	0.020	Type F	C
CL	0.035	Type F	G										
Yarraman (ya)	generally low lying area subject to high run-on, permanently high watertables, seasonal waterlogging and flooding; very high water erosion hazards; widespread aquifer re-charge and salinity; widespread risks to foundations		Group C	none						CH	0.019	Type D	J
										CH	0.015	Type D	J
										CH	0.025	Type D	H
										CH	0.030	Type D	H
										CH	0.019	Type D	G&F
					CH	0.033	Type F	H					
					CH	0.027	Type D	H					
					CH	>0.092	Type F	H					

Table C8. Tamworth Soil Landscapes

Table 8 Tamworth Soil Landscapes								
Soil landscape	Soil hydrologic group	Percent area of high acid sulfate soil risk	Acid sulfate risk	Percent area of low acid sulfate soil risk*	USCS class	K-factor USLE (t.ha.h/ha.M J.mm)	Sediment type	Sediment basin wall construction (earth)
Basin Gully (ba)	Group C	0.00	none	0.00	CH	0.017	Type D	J
					CH	0.025	Type F	H
					CL	0.035	Type F	B
					CH	0.016	Type D	J
					CH	0.016	Type F	H
					SM	0.038	Type F	J
Babinboon (bb)	Group C	0.00	none	0.00	SM-ML	0.042	Type F	J
					CL	0.019	Type F	A
					CL	0.028	Type F	G
					SM	0.020	Type F	B&I
					ML	0.044	Type D	J
					CL	0.030	Type F	A
					CH	0.028	Type F	G
					OL	0.019	Type F	J
					CL	0.026	Type F	B
					CL	0.021	Type F	G
Brigalows (br)	Group C	0.00	none	0.00	CL	0.028	Type F	J
					CL	0.030	Type D	A
	Group C/D				SM	0.022	Type F	J
					CL	0.020	Type F	G
	Group C				CL	0.025	Type F	A
					SM	0.034	Type C	I
					OL	0.011	Type F	J
					CH	0.013	Type D	H
					CL	0.024	Type D	H
					CL	0.038	Type F	B
					SM	0.029	Type F	B&I
					ML	0.024	Type D	J
					CH	0.014	Type D	F
					CH	0.016	Type D	G
					SM	0.022	Type F	J
					SM	0.027	Type D	J
SC	0.019	Type D	B					
Currabubula Creek (cc)	Group C/D	0.00	none	0.00	ML	0.040	Type F	J
					ML	0.051	Type F	A
					ML	0.047	Type F	A
	Group D				CL	0.033	Type F	J
					CL	0.038	Type F	B
					ML	0.040	Type F	A
	Group B				SM	Peaty	Type F	J
					SM	0.024	Type F	J
					SM	0.035	Type F	I
					ML	0.064	Type F	C
	Group B				SM-ML	0.033	Type F	J
					SM	0.019	Type C	I
					SM-ML	0.038	Type F	J/B
					CH	0.059	Type F	J
					CH	0.022	Type F	H
	Group C				CH	>0.073	Type F	H
CH		0.014	Type F	J				
CH		>0.081	Type F	H				
Conadilly (cd)	Group B/C	0.00	none	0.00	OL	0.007	Type F	J
					CH	0.010	Type D	H
					CH	0.009	Type D	F
					CH	0.009	Type D	F
					CH	0.046	Type F	H

Table C8. Tamworth Soil Landscapes (continued)

Table 8 Tamworth Soil Landscapes									
Soil landscape	Soil hydrologic group	Percent area of high acid sulfate soil risk	Acid sulfate risk	Percent area of low acid sulfate soil risk*	USCS class	K-factor USLE (t.ha.h/ha.M J.mm)	Sediment type	Sediment basin wall construction (earth)	
					CH	0.020	Type D	H	
					CH	0.017	Type D	H	
					CH	0.015	Type D	F	
					CH	0.012	Type D	H	
					CH	0.011	Type D	H	
					CH	0.028	Type F	H	
Canna Gap (cg)	Group C/D Group C	0.00	none	0.00	SM	0.035	Type F	J	
					GM	0.038	Type C	I	
	CH				0.015	Type D	H		
	Group B				SM	0.025	Type C	J	
	SM				0.025	Type C	J		
Daruka (da)	Group D	0.00	none	0.00	GM	0.040	Type F	J	
					ML	0.033	Type D	A	
					GM	0.020	Type C	J	
					CL	0.017	Type F	A	
Duff's Gully (dg)	Group C/D	0.00	none	0.00	CL	0.016	Type F	J	
					CL	0.018	Type D	H	
					CL	0.015	Type D	H	
					CL	0.020	Type D	J	
					CH	0.015	Type D	H	
					CH	0.014	Type D	G&F	
					Group C	ML	0.034	Type F	J
					CL	>0.076	Type F	H	
	CL				>0.081	Type F	G		
	SM				0.040	Type F	J		
	SC				0.016	Type F	K		
	CL				0.026	Type F	H		
	CH				0.012	Type D	H		
	Group D				CH	0.012	Type D	H	
	CH				0.007	Type D	J		
	CH				0.010	Type D	H		
	CH				0.013	Type D	H		
	CH				0.018	Type D	H		
	ML				0.034	Type D	A		
Dead Horse (dh)	Group C/D	0.00	none	0.00	CL	0.029	Type F	J	
					CH	0.012	Type D	F	
					CH	0.016	Type D	D	
					CH	0.016	Type D	H	
					CH	0.014	Type D	F	
	Group D				CH	0.016	Type D	J	
					ML	0.044	Type D	B	
					ML	0.026	Type F	A	
					CL	0.027	Type F	G	
					CH	0.018	Type D	H	
	Group C/D				CH	0.018	Type D	H	
					CH	0.017	Type D	H	
					SM	0.031	Type F	J	
					CL	0.019	Type D	G	
CH	0.013	Type D	H						
Dunover (do)	Group C	0.00	none	0.00	ML	0.046	Type F	J	
					ML	0.022	Type F	K	
					OL	0.026	Type F	J	
	Group D				ML	0.041	Type F	A	
					CH	0.019	Type F	H	
					SM	0.026	Type F	J	

Table C8. Tamworth Soil Landscapes (continued)

Table 8 Tamworth Soil Landscapes									
Soil landscape	Soil hydrologic group	Percent area of high acid sulfate soil risk	Acid sulfate risk	Percent area of low acid sulfate soil risk*	USCS class	K-factor USLE (t.ha.h/ha.M J.mm)	Sediment type	Sediment basin wall construction (earth)	
Duri (du)	Group B	0.00	none	0.00	SM	0.029	Type F	I	
					SM	0.026	Type F	J	
					SM-ML	0.035	Type F	B&I/A	
					ML	0.040	Type F	A	
	Group C				ML	0.054	Type F	A	
					SM	0.033	Type F	J	
					CH	0.016	Type D	G	
	Group C				Group C	CH	0.016	Type D	H
						SP	0.012	Type C	J
						SP	0.012	Type C	K
					Group C/D	CH	0.054	Type F	J
						CH	0.013	Type F	H
ML		0.045	Type D	J					
CL		0.016	Type F	G					
ML		0.044	Type F	J					
ML		0.057	Type F	A					
CL		0.021	Type F	G					
Group D	ML	0.046	Type D	J					
	ML	0.046	Type D	A					
	SM	0.028	Type F	J					
Escott (es)	Group B/C	SM	0.032	Type F	J				
		CL	0.017	Type D	G				
		SM	0.031	Type F	J				
Eurunderee (eu)	Group B/C	SM	0.018	Type C	I				
		SM	0.038	Type F	J				
	Group C	SM	0.044	Type F	I				
		CL	0.028	Type F	A				
		SC	0.029	Type F	B				
		SM-ML	0.034	Type D	J				
		SM	0.044	Type D	J				
		SC	0.026	Type F	A				
		SC	0.028	Type F	B				
		Fullwoods Hill (fh)	Group C	ML	0.043	Type F	J		
SC	0.042			Type F	C				
Group C/D	OL		0.028	Type F	J				
	CL		0.015	Type F	G				
	CL		0.017	Type F	G				
	CL		0.017	Type F	G				
	SM-ML		0.016	Type F	J				
Group B/C	ML		0.026	Type F	A				
	ML		0.047	Type F	J				
Group C	ML		0.042	Type D	B				
	CL		0.015	Type D	G				
	CL		0.022	Type D	G				
	The Forest (fo)	Group B/C	CL	0.041	Type F	J			
CH			0.052	Type F	H				
CL			0.023	Type F	H				
Group C		CL	0.024	Type F	H				
		ML	0.025	Type F	J				
		CL	0.013	Type D	H				
		CH	0.061	Type F	H				
		OL	0.038	Type D	J				
		ML	0.052	Type D	A				
		CL	0.031	Type D	B				
ML	>0.087	Type F	C						

Table C8. Tamworth Soil Landscapes (continued)

Table 8 Tamworth Soil Landscapes								
Soil landscape	Soil hydrologic group	Percent area of high acid sulfate soil risk	Acid sulfate risk	Percent area of low acid sulfate soil risk*	USCS class	K-factor USLE (t.ha.h/ha.M J.mm)	Sediment type	Sediment basin wall construction (earth)
Granny's Armchair (ga)	Group D	0.00	none	0.00	SM	0.014	Type C	J
					SM	0.018	Type F	J
					SM	0.026	Type F	J
	Group B				SM	0.013	Type C	J
					SM	0.021	Type C	I
Glenmore (gm)	Group C	0.00	none	0.00	ML	0.012	Type F	J
					CH	0.018	Type D	H
					CH	0.020	Type D	H
					ML	0.025	Type F	J
					CH	0.021	Type F	H
					CH	>0.087	Type F	H
					CH	0.055	Type F	J
					CH	0.015	Type F	H
					CH	0.015	Type D	H
	Group B				ML	0.032	Type F	J
					CH	0.050	Type F	C
					ML	0.056	Type F	J
Goonoo Goonoo (gn)	Group D	0.00	none	0.00	OL	0.031	Type F	J
					SC	0.020	Type C	I
					CL	0.031	Type F	A
					CL	0.036	Type F	G
					CH	0.022	Type F	G
	Group C				SC	0.025	Type F	B
					ML	0.035	Type D	J
					ML	0.020	Type D	A
					CH	0.015	Type D	G
					ML	0.037	Type F	J
	Group B				ML	0.047	Type F	C
					ML	0.039	Type F	A
					ML	0.036	Type F	A
					SM	0.023	Type F	B&I
					CL	0.029	Type D	J
					CH	>0.078	Type F	H
					CH	0.012	Type D	B
					OL	0.031	Type D	J
					OL	0.013	Type D	J
					CL	>0.079	Type F	C
CL	>0.070	Type F	C					
Gaspard Road (gr)	Group D	0.00	none	0.00	SM-ML	0.032	Type F	J
					CL	0.015	Type F	H
					CH	0.016	Type D	H
					ML	0.027	Type D	J
					ML	0.045	Type D	D
					CH	0.012	Type D	H
	Group C				CH	0.013	Type F	J
					CL	0.018	Type D	H
					CL	0.014	Type D	H
	Group D				ML	0.025	Type F	J
					CL	0.014	Type D	H
	Group C				ML	0.021	Type F	J
					CH	0.016	Type D	H
Killphysic Road (kr)	Group C	0.00	none	0.00	OL	0.025	Type F	J
					ML	0.039	Type F	A
					CL	0.021	Type F	H

Table C8. Tamworth Soil Landscapes (continued)

Table 8 Tamworth Soil Landscapes										
Soil landscape	Soil hydrologic group	Percent area of high acid sulfate soil risk	Acid sulfate risk	Percent area of low acid sulfate soil risk*	USCS class	K-factor USLE (t.ha.h/ha.M J.mm)	Sediment type	Sediment basin wall construction (earth)		
Granny's Armchair (ga)	Group D	0.00	none	0.00	SM	0.014	Type C	J		
					SM	0.018	Type F	J		
					SM	0.026	Type F	J		
	Group B	0.013	Type C	J						
			0.021	Type C	I					
Glenmore (gm)	Group C	0.00	none	0.00	ML	0.012	Type F	J		
					CH	0.018	Type D	H		
					CH	0.020	Type D	H		
					ML	0.025	Type F	J		
					CH	0.021	Type F	H		
					CH	>0.087	Type F	H		
					CH	0.055	Type F	J		
					CH	0.015	Type F	H		
					CH	0.015	Type D	H		
	Group B	0.032	Type F	J						
			0.050	Type F	C					
			0.056	Type F	J					
Goonoo Goonoo (gn)	Group D	0.00	none	0.00	OL	0.031	Type F	J		
					SC	0.020	Type C	I		
					CL	0.031	Type F	A		
					CL	0.036	Type F	G		
					CH	0.022	Type F	G		
					SC	0.025	Type F	B		
					Group C	none	0.035	Type D	J	
								0.020	Type D	A
								0.015	Type D	G
								0.037	Type F	J
	Group B	0.047	Type F	C						
			0.039	Type F	A					
			0.036	Type F	A					
			0.023	Type F	B&I					
			0.029	Type D	J					
			>0.078	Type F	H					
	Gaspard Road (gr)	Group D	0.00	none	0.00	SM-ML	0.032	Type F	J	
						CL	0.015	Type F	H	
						CH	0.016	Type D	H	
						ML	0.027	Type D	J	
ML						0.045	Type D	D		
Group C		0.012				Type D	H			
						0.013	Type F	J		
						0.018	Type D	H		
Group D		0.014				Type D	H			
						0.025	Type F	J		
Group C	0.014	Type D	H							
		0.021	Type F	J						
CH	0.016	Type D	H							
Killphysic Road (kr)	Group C	0.00	none	0.00	OL	0.025	Type F	J		
					ML	0.039	Type F	A		
					CL	0.021	Type F	H		

Table C8. Tamworth Soil Landscapes (continued)

Table 8 Tamworth Soil Landscapes												
Soil landscape	Soil hydrologic group	Percent area of high acid sulfate soil risk	Acid sulfate risk	Percent area of low acid sulfate soil risk*	USCS class	K-factor USLE (t.ha.h/ha.M J.mm)	Sediment type	Sediment basin wall construction (earth)				
Quipolly (qu)	Group C	0.00	none	0.00	CL	0.021	Type F	H				
					ML	0.024	Type F	J				
					CL	0.020	Type D	G				
					SM	0.031	Type F	J				
					SM	0.041	Type F	J				
	SM				0.035	Type F	B&I					
	Group C/D				SM	0.023	Type F	J				
					GM	0.034	Type C	I				
					SC	0.020	Type F	B				
					CL	0.018	Type F	J				
CL		0.036	Type D	B								
CL		0.034	Type D	G								
Moore Creek (mc)	Group B	0.00	none	0.00	ML	0.072	Type F	J				
					ML	0.030	Type F	K				
					SM	0.037	Type F	J				
	Group C				ML	0.058	Type F	J				
					SM	0.058	Type F	J				
	Group B				SM	0.032	Type F	B&I				
					CL	0.026	Type D	J				
					CH	0.018	Type D	H&F				
					CH	0.017	Type D	H&F				
					GC	0.019	Type D	K				
					SM	0.046	Type F	J				
	Moongabah (mg)				Group B	0.00	none	0.00	SM	0.014	Type C	J
									SP	0.014	Type C	J
					Group B/C				SM	0.034	Type F	J
									SM	0.038	Type F	J
CL		0.021	Type D	B								
Group B/C		SC	0.014	Type C	B							
		SM	0.027	Type C	J							
		SM	0.038	Type C	J							
		Group D	GM	0.026	Type F				J			
Group C	SM		0.038	Type F	J							
	ML	0.044	Type F	J								
	CL	0.028	Type D	A								
Narrawolga (na)	Group D	0.00	none	0.00	SM	0.030	Type F	J				
					SM	0.020	Type F	J				
	Group D				SM	0.023	Type F	J				
					SM	0.025	Type F	J				
					SM	0.032	Type D	J				
	Group C				CL	0.018	Type D	A				
					CL	0.022	Type D	A				
Orchard Creek (oc)	Group C	0.00	none	0.00	OL	0.046	Type D	J				
					ML	>0.073	Type D	D				
					ML	0.049	Type D	A				
					ML	>0.080	Type D	I				

Table C8. Tamworth Soil Landscapes (continued)

Table 8 Tamworth Soil Landscapes								
Soil landscape	Soil hydrologic group	Percent area of high acid sulfate soil risk	Acid sulfate risk	Percent area of low acid sulfate soil risk*	USCS class	K-factor USLE (t.ha.h/ha.M J.mm)	Sediment type	Sediment basin wall construction (earth)
Peel (pe)	Group D	0.00	none	0.00	GM	0.026	Type F	J
					CL	0.051	Type F	G
	Group B				PT	Peaty	Type F	J
					ML	0.029	Type D	B
	Group C				SC	0.021	Type F	B
					ML	0.031	Type D	J
					CH	0.023	Type D	G
	Group B/C				CL	0.021	Type D	G
					OL	0.014	Type F	J
					CL	0.029	Type D	E
					CL	0.026	Type D	G
	Group B				OL	0.027	Type D	J
					CH	0.017	Type D	F
					ML	0.032	Type D	J
ML		0.044	Type D	B				
ML		0.024	Type F	J				
ML		0.045	Type F	A				
Pine Knob (pk)	Group B/C	0.00	none	0.00	SM	0.026	Type F	J
					SM	0.024	Type F	J
					SC	0.026	Type F	B
Parnell (pl)	Group C/D	0.00	none	0.00	SM	Peaty	Type F	J
					GP-SM	0.035	Type F	J
					OL	0.020	Type F	J
	Group C				ML	0.044	Type F	J
					CL	0.022	Type F	G
	Group C				SM	Peaty	Type F	J
					SW	0.033	Type F	nt
					OL	0.012	Type D	J
					CH	0.014	Type D	H
					CH	0.018	Type D	H
Quirindi Creek (qc)	Group C	0.00	none	0.00	CL	0.066	Type F	J
					ML	0.039	Type F	A
					SM-ML	0.034	Type F	B&I/A
					CL	0.026	Type D	J
					CH	0.026	Type D	H
					CH	0.032	Type F	H
					CH	0.022	Type D	H
					SM-ML	0.023	Type F	K/A
					CL	0.044	Type F	B
					SM	0.017	Type C	I
	Group C				CH	0.033	Type D	G
					ML	0.024	Type D	J
					CH	0.015	Type D	G
					CH	0.012	Type D	H
					CH	0.016	Type D	H
					CH	0.012	Type D	J
					CH	0.013	Type D	H
					ML	0.034	Type F	J
					CH	0.017	Type D	F
					CH	0.017	Type D	F
Quipolly (qu)	Group D	0.00	none	0.00	SC	0.022	Type F	J
	Group C/D				SC	0.023	Type F	J
					SC	0.027	Type F	B
	Group C				CH	0.016	Type F	J
					CH	0.016	Type D	H

Table C8. Tamworth Soil Landscapes (continued)

Table 8 Tamworth Soil Landscapes								
Soil landscape	Soil hydrologic group	Percent area of high acid sulfate soil risk	Acid sulfate risk	Percent area of low acid sulfate soil risk*	USCS class	K-factor USLE (t.ha.h/ha.M J.mm)	Sediment type	Sediment basin wall construction (earth)
					CH	0.017	Type D	H
Round Hill (rh)	Group C	0.00	none	0.00	SM	0.034	Type D	J
					CL	0.039	Type D	K
					SC	0.020	Type D	K
					ML	0.033	Type D	J
	Group D Group C				CL	0.021	Type D	B
					CL	0.028	Type D	B
					SC	0.020	Type F	J
					SC	0.021	Type F	J
CH	0.015	Type D	G					
Spring Creek (sc)	Group C	0.00	none	0.00	OL	0.019	Type F	J
	Group B Group D				SC	0.030	Type F	B
					ML	0.011	Type F	J
	Group C/D				GM	0.002	Type F	J
					SM	0.016	Type F	J
	SM				0.014	Type F	J	
The Siphon (si)	Group C	0.00	none	0.00	GC	0.031	Type F	J
					ML	0.050	Type F	C
					CH	0.057	Type F	C
					CL	>0.086	Type F	G
					CH	0.011	Type D	J
					CH	0.014	Type D	H
					CH	0.017	Type F	J
					CH	0.017	Type D	H
					CH	0.015	Type D	F
					CL	0.031	Type D	B
					CL	0.027	Type F	G
					OL	0.023	Type F	J
					ML	0.035	Type F	A
					ML	0.035	Type F	A
Slippery Rock (sr)	Group B/C	0.00	none	0.00	SM	0.029	Type F	J
	Group D Group B/C				SM	0.030	Type F	B&I
					SM	0.026	Type C	J
					SM	0.025	Type F	J
					SM	0.029	Type F	J
					SM	0.028	Type D	J
	Group D				GP-SM	0.033	Type F	J
Terrible (te)	Group D Group C	0.00	none	0.00	SM	0.018	Type F	J
	SM				0.028	Type F	J	
	SM				0.028	Type F	B&I	
	SM				0.029	Type C	J	
Thunderbolt's Mountain (th)	Group D Group C	0.00	none	0.00	SM	0.027	Type F	J
	Group D				SM-ML	0.017	Type F	J
					CL	0.028	Type F	H
					SM	0.043	Type F	J
					CH	0.013	Type D	J
					CL	0.022	Type D	B
					CL	0.020	Type D	B
					SC	0.029	Type F	J
CL	0.014	Type D	H					
Taggarts Mountain (tm)	Group B	0.00	none	0.00	OL	0.026	Type F	J
					SM	0.035	Type F	B&I
					CL	0.016	Type D	G

Table C8. Tamworth Soil Landscapes (continued)

Table 8 Tamworth Soil Landscapes								
Soil landscape	Soil hydrologic group	Percent area of high acid sulfate soil risk	Acid sulfate risk	Percent area of low acid sulfate soil risk*	USCS class	K-factor USLE (t.ha.h/ha.M J.mm)	Sediment type	Sediment basin wall construction (earth)
	Group C				ML	0.019	Type F	J
					CL	0.018	Type D	H
	Group B				SM	0.021	Type F	J
					SM	0.031	Type F	J
					SM	0.029	Type F	J
					ML	0.037	Type F	A
	Group C/D				SM	0.025	Type F	J
					ML	0.044	Type D	B
					SC	0.034	Type F	J
					ML	0.035	Type D	B
Mount Winton (wi)	Group C	0.00	none	0.00	CH	0.011	Type D	J
					CH	0.015	Type D	H
					CL	0.025	Type F	H
					CL	0.045	Type F	B
					CL	0.003	Type F	J
					CL	0.008	Type F	G
	Group D				SM	0.021	Type F	J
					SM	0.021	Type F	J
	Group C/D				GM	0.031	Type F	J
					GC	0.028	Type F	B
Wangarang (wn)	Group C	0.00	none	0.00	ML	0.037	Type D	J
					SM	0.039	Type D	J
					CL	0.038	Type D	B
					ML	0.040	Type F	J
					ML	0.032	Type F	A
					CL	0.028	Type D	G
					SC	0.015	Type F	J
					ML	0.047	Type D	E
					ML	0.071	Type D	E
Warral Station (ws)	Group C	0.00	none	0.00	CL	0.028	Type F	J
					CL	0.049	Type F	C
					CL	0.033	Type F	A
					CL	0.036	Type F	B
					ML	0.036	Type D	J
					CH	0.017	Type D	H
					CL	0.032	Type F	B
					CL	0.041	Type F	B
					CL	0.034	Type D	J
					ML	0.056	Type D	D
					CH	0.061	Type F	C
					CL	0.069	Type F	C
					CL	0.030	Type F	J
					CL	0.029	Type F	B
					SM	0.021	Type C	K
					SC-CL	0.017	Type F	K/H
					CL	0.025	Type F	G
					ML	0.028	Type F	J
					OL	0.016	Type F	J
					ML	>0.075	Type F	K
					CH	0.021	Type F	G
					ML	0.025	Type F	J
					CL	0.017	Type F	H
					CH	0.014	Type D	H
					CL	0.017	Type D	H
Wyalga Mountain	Group C/D	0.00	none	0.00	SM	0.018	Type F	J

Table C8. Tamworth Soil Landscapes (continued)

Table 8 Tamworth Soil Landscapes								
Soil landscape	Soil hydrologic group	Percent area of high acid sulfate soil risk	Acid sulfate risk	Percent area of low acid sulfate soil risk*	USCS class	K-factor USLE (t.ha.h/ha.M J.mm)	Sediment type	Sediment basin wall construction (earth)
(wy)	Group D	0.00	none	0.00	CL	0.015	Type F	G
					SM	0.017	Type F	J
					CL	0.019	Type F	J
					CL	0.017	Type F	A
	Group C/D				SM	0.015	Type F	J
					SC	0.020	Type F	B
					CH	0.013	Type F	G
					CL	0.017	Type F	G
Yilgarn (yi)	Group B	0.00	none	0.00	SM	0.020	Type F	J
					SM	0.022	Type F	J
					SM	0.021	Type F	J
					SM	0.023	Type C	J
					SM	0.027	Type C	I
					SM	0.019	Type C	I
					SM	0.019	Type C	I
					SM	0.023	Type C	J
					SM	0.027	Type C	I
					SM	0.031	Type C	I
Yarramine (yr)	Group B	0.00	none	0.00	SM	0.032	Type F	J
					SM	0.025	Type C	J
					SM	0.032	Type F	I
					SC	0.013	Type F	B
					SM	0.030	Type F	J

* LOW RISK, or no risk

Table C9. Kempsey-Korogoro Point Soil Landscapes

Table 9 Kempsey-Korogoro Point						
Soil landscape	Soil hydrologic group	Acid sulfate risk	USCS Class	K-factor USLE	Sediment type	Sediment basin wall construction (earth)
Austral Eden (ae)	Group C	endemic	MH	>0.053	Type F	I
			MH	0.056	Type D	B
	Group B		MH	>0.054	Type F	B
			MH	0.060	Type D	B
Aldavilla (al)	Group B/C	sporadic	MH	0.053	Type D	B
			MH	0.059	Type D	D
	Group B/C		CL	0.023	Type D	A
			CL	0.033	Type D	B
			SC	0.034	Type D	B
			MH-CL	0.049	Type D	D
Beranghi (be)	Group C/D	sporadic	ML	0.032	Type F	B
			CL	0.023	Type D	B
			CL	>0.081	Type F	C
			CL	>0.087	Type F	C
			CL	0.073	Type F	C
			CL	>0.084	Type F	C
	Group C		MH	0.054	Type D	B
			CL	0.075	Type F	C
Belgrave Falls (bf)	Group A/B	sporadic	MH	>0.059	Type F	I
			MH	0.047	Type F	I
	Group A		SP	0.019	Type F	J
			CL	0.036	Type F	D
			SP	0.007	Type C	J
			SC	0.010	Type F	I
Belmore (bl)	Group D	endemic	ML	Peaty	Type F	C
			CL	>0.044	Type F	C
	Group C/D		MH	0.057	Type F	nt
Blackmans Point (bp)	inapplicable	endemic	CL	Peaty	Type F	B
			CL	0.038	Type F	nt
			CL	0.063	Type F	nt
			CL	0.033	Type F	nt
Beechwood (bw)	Group B/C	none	MH	0.042	Type F	A
			MH	0.038	Type F	A
			CL	0.031	Type F	A
			CL-CH	0.068	Type F	C
			CL-CH	0.078	Type F	C
			CL	0.038	Type D	D
			CL	>0.086	Type F	C
			CL	>0.086	Type F	C
Belangry (by)	Group C/D	none	SW	0.025	Type F	I
			SC	0.028	Type F	I
			SC	0.021	Type F	B
			ML	0.010	Type F	C
			CL	0.016	Type F	A
			CL	0.028	Type F	A
	Group C		SC	0.022	Type F	B
			SC	0.030	Type F	B
			CL	>0.083	Type F	C
Cairncross (ca)	Group C/D	common		0.047	Type F	nt
					Type F	nt
					Type D	nt
	Group D		CL	Peaty	Type F	B

Table C9. Kempsey-Korogoro Point Soil Landscapes (continued)

Table 9 Kempsey-Korogoro Point						
Soil landscape	Soil hydrologic group	Acid sulfate risk	USCS Class	K-factor USLE	Sediment type	Sediment basin wall construction (earth)
			CL	0.047	Type D	D
			CL	0.031	Type D	D
			CH	0.022	Type D	nt
	Group C/D		CL	0.029	Type D	A
			CL	0.038	Type D	A
			CL	>0.098	Type F	C
Connection Creek (cc)	inapplicable	endemic	ML	Peaty	Type F	A
			MH	Peaty	Type F	I
			CL	Peaty	Type F	C
			ML	Peaty	Type F	A
			CL	0.036	Type D	A
Crescent Head (ch)	Group B/C	sporadic	ML	0.031	Type F	I
			ML	0.029	Type F	A
			CL	0.024	Type D	B
			SC	0.030	Type F	B
			SC-CL	0.042	Type D	D
	Group C		SC-CL	0.040	Type D	B
			SM	0.031	Type F	J
			SM	0.043	Type D	nt
Christmas Creek (ck)	Group C	endemic	MH	0.042	Type D	A
			MH	0.045	Type D	B
			CL	Peaty	Type F	C
			MH	Peaty	Type D	I
	Group C/D		MH	0.080	Type F	C
			CH		Type F	A
			CH		Type D	B
			CH		Type D	B
			CH		Type D	B
			CH		Type D	B
			CH		Type D	B
			CH		Type D	A
			CH		Type F	C
Combatine (co)	Group C/D	none	SC	0.033	Type D	B
			ML	0.036	Type F	B
			MH	0.058	Type D	I
			MH-CL	0.037	Type D	D
Cooperabung (cp)	Group B/C	none	SM	0.046	Type F	J
			SM	0.040	Type D	J
			SM	0.027	Type F	J
			ML	0.027	Type F	A
			CL	0.035	Type D	B
			CL	0.024	Type D	A
			CL	0.040	Type F	B
			MH	>0.040	Type D	B
			MH	0.046	Type D	nt
			CL	0.050	Type D	D
Red Hill (rh)	Group B/C	none	CL	0.010	Type F	C
			CL	0.063	Type F	C
			CH	0.058	Type F	C
			CL	>0.039	Type F	C
			CL	Peaty	Type F	C
Delicate (de)	Group B	endemic	ML	Peaty	Type F	I
			CL	0.035	Type D	B

Table C9. Kempsey-Korogoro Point Soil Landscapes (continued)

Table 9 Kempsey-Korogoro Point						
Soil landscape	Soil hydrologic group	Acid sulfate risk	USCS Class	K-factor USLE	Sediment type	Sediment basin wall construction (earth)
			SC	0.042	Type F	B
Euroka (eu)	Group C	sporadic	CL	0.037	Type D	D
			CH	0.011	Type F	C
Five Ways (fw)	Group B	none	CL	0.020	Type F	C
			CL	>0.067	Type F	C
			MH	>0.044	Type D	B
			CL	>0.086	Type F	C
	Group C		ML	0.027	Type F	I
			MH	0.041	Type D	B
			CL	0.012	Type D	A
	Group D		MH	0.031	Type D	A
			SM	0.058	Type D	J
Gladstone (gd)	Group B	endemic	MH	0.072	Type D	D
	Group D		MH	>0.051	Type D	A
			CL	0.052	Type F	C
			CL	0.046	Type D	D
			SC	0.036	Type F	C
			MH-CL	>0.062	Type F	C
			SC	0.033	Type C	I
Gearys Mountain (gm)	Group D	none	ML-CL	0.029	Type F	B
			MH	0.051	Type D	nt
	Group B/C		ML	0.043	Type F	A
			CL	0.061	Type D	B
			CL	0.030	Type D	A
			ML	Peaty	Type F	A
			ML-CL	0.019	Type F	B
			CL	0.019	Type F	A
Goolwah (go)	Group A	sporadic	SP	0.010	Type F	I
			SP	0.006	Type C	J
Hat Head (hh)	inapplicable	sporadic	SW	0.022	Type C	I
			SW	0.022	Type C	I
			SW	0.016	Type F	I
			SW	0.026	Type C	I
			PT	Peaty	Type F	J
			SW	0.030	Type F	I
Huntingdon (hn)	Group B	sporadic	MH	0.034	Type F	A
			MH-CL	0.048	Type D	D
	Group C		CL	0.042	Type D	B
			CL	0.037	Type D	D
			MH	0.044	Type F	K
Hursley (hy)	Group C	sporadic	MH	0.037	Type F	A
			CL	0.042	Type F	B
			CL	>0.081	Type F	C
			CL-CH	>0.085	Type F	C
			CL	0.078	Type F	C
Kundabung (kg)	Group D	sporadic		0.041	Type F	nt
					Type D	nt
				0.033	Type F	nt
					Type D	nt
					Type D	nt
	Group C			0.044	Type F	nt

Table C9. Kempsey-Korogoro Point Soil Landscapes (continued)

Table 9 Kempsey-Korogoro Point						
Soil landscape	Soil hydrologic group	Acid sulfate risk	USCS Class	K-factor USLE	Sediment type	Sediment basin wall construction (earth)
					Type D	nt
					Type D	nt
			MH	0.046	Type F	A
			CL	0.017	Type F	C
			CL	>0.094	Type F	C
Killick (ki)	Group A	sporadic	SP	0.003	Type C	J
			SP	0.005	Type C	J
			SP	0.031	Type C	J
			SP	0.006	Type C	I
Kogo (ko)	Group C/D	none	ML	0.015	Type F	A
			SC	0.035	Type D	B
Korogoro (kr)	Group A	common	SW	0.005	Type F	J
			SP	0.009	Type C	I
			SP	0.016	Type F	I
			SP	0.011	Type C	I
			SM	0.026	Type F	I
Long Flat (lf)	Group B/C	sporadic	SC	0.026	Type F	B
			ML	0.035	Type F	B
			MH-CL	0.033	Type D	B
			SP	0.013	Type F	J
Limeburners (li)	Group A/B	sporadic	SP	0.024	Type F	J
			SC	0.032	Type F	I
			SC	0.025	Type F	I
			SP	0.022	Type F	J
			SP	0.023	Type F	J
McGuire's Crossing (mc)	inapplicable	endemic	PT	Peaty	Type F	J
			SP	0.014	Type C	I
						nt
Marlo Merrican (mm)	Group B	none	MH	Peaty	Type F	I
			CH	>0.089	Type F	C
	Group C		MH	0.040	Type F	A
			CL	0.037	Type F	B
			SC	0.021	Type F	B
			ML-CL	0.045	Type D	D
			CL	0.025	Type D	G
			MH	>0.057	Type D	A
			CH	>0.071	Type F	C
Moripo (mo)	Group C/D	none	MH	0.053	Type F	B
			CL	0.035	Type F	A
			CL	0.025	Type D	B
			CL	0.033	Type D	B
Maria River (mr)	Group D	endemic	MH	0.036	Type D	A
			CL	0.048	Type D	D
			CL	0.052	Type D	B
				0.053	Type F	nt
					Type D	nt
	Group D			0.049	Type F	nt
					Type F	nt
				0.041	Type F	nt
	Group D				Type D	nt
					Type D	nt

Table C9. Kempsey-Korogoro Point Soil Landscapes (continued)

Table 9 Kempsey-Korogoro Point						
Soil landscape	Soil hydrologic group	Acid sulfate risk	USCS Class	K-factor USLE	Sediment type	Sediment basin wall construction (earth)
				0.018	Type F	nt
					Type D	nt
				0.035	Type F	nt
					Type F	nt
				Peaty	Type F	nt
					Type D	nt
					Type D	nt
				Peaty	Type F	nt
					Type C	nt
North Shore (ns)	Group A	widespread	SP	0.004	Type C	I
			SP	0.000	Type C	I
			SP	0.002	Type C	I
			SP	0.000	Type C	I
O'Connors (oc)	Group D	sporadic	SW	0.015	Type F	J
			SP	0.009	Type F	I
	Group A		SP	0.010	Type F	I
			SP	0.008	Type C	I
Pipers Creek (pc)	Group B/C	common	MH	0.047	Type D	B
			MH	>0.078	Type D	D
			CL	0.033	Type D	A
			CH	>0.092	Type F	C
			CL	0.033	Type D	A
			CL	0.032	Type D	B
Plomer Road (pr)	Group A	endemic	SC	0.016	Type F	I
			SP	0.015	Type F	I
			SP	0.014	Type F	I
			SP	0.009	Type C	I
Redbank (rb)	Group B	none	ML	0.012	Type F	C
			CL	0.044	Type F	B
			CL	0.059	Type F	C
			CL	0.043	Type F	C
			CL	>0.080	Type F	C
	Group B		CL	0.014	Type F	C
			CL	0.064	Type F	G
Rocks Ferry (rf)	Group C	common	MH	0.044	Type F	A
			CL	0.045	Type D	B
Snowy Road (sr)	Group C/D	none	SC-CL	0.023	Type F	B/A
			SC-CL	0.022	Type F	B/A
	Group D		SC	0.013	Type F	C
	Group C		SP	0.041	Type F	I
			SP	0.042	Type F	J
			CL	0.027	Type F	A
	Group D		ML-SC	0.010	Type F	B
			SC-CL	0.019	Type F	B/A
			CL	0.058	Type F	C
Thrumster (th)	Group C	sporadic	MH	0.009	Type F	C
			MH	0.032	Type D	A
			CH	0.040	Type F	C
			CL	0.063	Type F	C
			CL	0.041	Type F	B
			CH	0.046	Type F	C

Table C9. Kempsey-Korogoro Point Soil Landscapes (continued)

Table 9 Kempsey-Korogoro Point						
Soil landscape	Soil hydrologic group	Acid sulfate risk	USCS Class	K-factor USLE	Sediment type	Sediment basin wall construction (earth)
Tinebank (ti)	Group B	none	SC	0.026	Type F	B
			CL	0.082	Type F	C
	SC		0.018	Type F	C	
	SC		0.035	Type F	C	
	Group C		SC	0.028	Type F	C
			SC	0.036	Type F	B
Torrens (to)	Group C/D	widespread	SC	0.011	Type F	B
			SC	0.007	Type F	C
			SP	0.020	Type C	J
Disturbed terrain (xx)	Group A		SP	0.006	Type C	nt
			SP	0.002	Type C	I
Yessabah (ye)	Group C/D	none	ML	Peaty	Type F	A
			CL	0.039	Type F	B
			CL	0.021	Type D	G
			CL	0.018	Type D	A
			SC	0.030	Type F	B
	Group C		CL	0.020	Type D	A
			CL	0.017	Type F	A

Table C10. Blackville Soil Landscapes

Table C10 Blackville Soil Landscapes							
Soil landscape	Slope range (%)	Soil hydrologic group	Acid Sulfate Risk	USCS Class	K-factor USLE	Sediment type	Sediment basin wall construction (earth)
Ant Hill (ah)	8 to 32	Group D Group C	none	CH	>0.047	Type F	J
				PT	Peaty	Type F	J
				OL	0.020	Type F	J
				CL	0.029	Type F	J
				OL	0.027	Type F	J
				CH	0.024	Type F	H
				CH	0.022	Type F	H
				CH	0.016	Type F	H
				CH	0.024	Type F	H
				CH	0.057	Type F	H
				CL	0.036	Type F	H
				CH	0.014	Type F	H
				CH	0.016	Type F	H
Bow (bw)	1 to 8	?	none	GC	0.010	Type F	K
				CH	0.010	Type F	H
				CH	0.014	Type F	H
				OL	0.022	Type C	J
				OL	Peaty	Type F	J
				OH	>0.035	Type F	J
				OL	0.020	Type F	J
				SC-CL	0.040	Type F	J
				OL	0.030	Type F	J
				CL	0.036	Type F	C
				CL	0.031	Type F	G
				CH	0.034	Type F	H
				CH	0.066	Type F	H
Coober Bulga (cb)	>33	Group D Group C Group B/C Group C	none	CH	0.051	Type F	H
				PT	Peaty	Type F	J
				OL	0.016	Type F	J
				PT	Peaty	Type F	J
				PT	Peaty	Type F	J
				OL	Peaty	Type F	J
				OL	0.027	Type F	J
				ML	>0.066	Type F	C
				ML	>0.068	Type F	C
				CL	0.042	Type F	C
				CH	0.015	Type F	H
				CH	0.007	Type F	H
				CH	0.036	Type F	H
CH	0.052	Type F	H				
Conadilly (cd)	<0.5	Group B/C Group B/C	none	CH	0.059	Type F	J
				CH	0.039	Type F	J
				CL	0.062	Type D	K
				CH	0.018	Type F	H
				CH	0.020	Type F	H
				CH	0.010	Type F	F
				CH	0.012	Type F	H
				CH	0.013	Type F	H
				CH	0.015	Type F	F
				CH	>0.056	Type F	J
				CH	0.016	Type D	H
				CH	0.026	Type D	H
				Cranbourne (ce)	1 to 10	Group B/C	none
PT	Peaty	Type F	J				
OL	0.027	Type F	J				

Table C10. Blackville Soil Landscapes (continued)

Table C10 Blackville Soil Landscapes							
Soil landscape	Slope range (%)	Soil hydrologic group	Acid Sulfate Risk	USCS Class	K-factor USLE	Sediment type	Sediment basin wall construction (earth)
Campions Hill (ch)	1 to 10	Group C	none	CH	0.033	Type F	H
				CL	0.043	Type F	G
				CL	0.038	Type F	J
				CH	0.022	Type F	H
				CL	0.038	Type F	K
				CH	0.059	Type F	H
				CL	0.026	Type D	H
				OL	0.013	Type D	J
				CH	0.033	Type F	J
				CH	0.022	Type F	H
				CH	0.013	Type F	H
				CH	0.012	Type D	H
				CH	0.017	Type D	H
				CL	0.007	Type F	H
CH	0.016	Type D	H				
CH	0.020	Type D	H				
Claremont Swamp (cs)	<1	Group D	none	OL	Peaty	#VALUE!	J
				CL	0.021	Type F	C
				CH	0.018	#VALUE!	nt
Erin (er)	1 to 8	Group B/C Group B/C	none	CH	0.037	Type F	H
				CH	0.037	Type F	H
				CH	0.046	Type F	H
				CH	0.051	Type F	H
				CH	0.056	Type F	H
Galla Gilla (gg)	>33	Group C	none	PT	Peaty	Type F	J
				PT	Peaty	Type F	J
				PT	Peaty	Type F	J
				CL	0.034	Type F	H
				CH	0.043	Type F	H
				SM	0.047	Type F	K
Glen Oak (gk)	2 to 10	Group C	none	OL	Peaty	Type F	J
				GM	Peaty	Type F	J
				OL	0.029	Type F	J
				CL	0.016	Type F	H
				CL	0.016	Type F	H
				CH	0.049	Type F	H
Kindamindi (ki)	1 to 20	Group C/D	none	OL	0.014	Type F	J
				PT	Peaty	Type F	J
				OL	0.017	Type F	J
				OL	Peaty	Type F	J
				ML	0.030	Type F	A
				CH	0.020	Type F	H
				CH	0.017	Type F	H
				CL	0.035	Type F	H
				CH	0.065	Type F	H
				CH	>0.064	Type F	H
Lever Gully (lg)	2 to 8	Group C	none	CH	0.043	Type F	J
				CH	0.045	Type F	H
				CH	0.008	Type F	H
				OL	0.023	Type F	J
				CH	0.020	Type D	H
				CH	0.019	Type F	H

Table C10. Blackville Soil Landscapes (continued)

Table C10 Blackville Soil Landscapes							
Soil landscape	Slope range (%)	Soil hydrologic group	Acid Sulfate Risk	USCS Class	K-factor USLE	Sediment type	Sediment basin wall construction (earth)
Lang's Neck (ln)	30 to 200	Group B/C Group C Group D Group B/C Group C	none	CH	0.011	Type F	H
				CH	0.012	Type F	H
				CH	0.047	Type F	H
				CH	>0.086	Type F	H
				CL	Peaty	Type F	J
				PT	Peaty	Type F	J
				PT	Peaty	Type F	J
				OL	0.019	Type F	J
				OL	0.023	Type F	J
				SM	0.040	Type F	J
Lochaber (lo)	<3	Group B	none	CH	0.044	Type F	H
				CL	0.032	Type F	H
Moan (mn)	10 to 30	Group B/C Group C Group B/C	none	OL	0.017	Type F	J
				CL	0.020	Type F	H
				PT	Peaty	Type F	J
				PT	Peaty	Type F	J
				CH	0.037	Type F	H
				OL	0.028	Type F	J
Mt Tamarang (mt)	30 to 80	Group C	none	OL	0.017	Type F	J
				CH	0.048	Type F	H
				CH	0.055	Type F	H
				SM-OL	0.006	Type F	J
				OL	0.020	Type F	J
				OL	0.018	Type F	J
				CH	0.037	Type F	H
				CH	0.021	Type F	H
				CH	0.047	Type F	H
Norfolk (no)	<3	Group D	none	SC-CL	0.033	Type F	A
				CL	0.043	Type F	K
				OL	Peaty	Type F	J
				SC	Peaty	#VALUE!	J
				OL	Peaty	Type F	J
				ML	0.043	Type F	J
Nany Rock (nr)	50 to 200	Group D	none	ML	0.019	#VALUE!	J
				ML	0.042	Type F	A
				SC	0.022	Type F	A
				SM	Peaty	Type F	J
				ML	0.042	Type F	A
Pigeon Box (pb)	10 to 30	Group D Group B Group C	none	OL	Peaty	Type F	J
				ML	0.044	Type F	J
				OL	Peaty	Type F	J
				OL	Peaty	Type F	J
				CL	0.014	Type F	C
Phillip's Creek (pc)	<3	Group C/D Group C Group C/D	none	ML	0.035	Type F	A
				ML	>0.052	Type F	J
				OL	0.041	Type F	J
				SC	0.016	Type F	J
				CH	0.022	Type F	H
				CL	0.021	Type F	H
				CH	0.034	Type D	H
				CH	0.060	Type F	H
				CH	0.057	Type F	H
CH	0.015	Type F	H				

Table C10. Blackville Soil Landscapes (continued)

Table C10 Blackville Soil Landscapes							
Soil landscape	Slope range (%)	Soil hydrologic group	Acid Sulfate Risk	USCS Class	K-factor USLE	Sediment type	Sediment basin wall construction (earth)
Trinkey Forest (tf)	<5	Group B/C	none	ML	>0.082	Type C	K
				SM	0.016	Type C	J
				OL	0.021	Type F	J
				SC	0.020	Type F	J
				SC	0.021	Type C	J
				SC	0.016	Type F	I
				SC	0.018	Type D	B
				SC	0.024	Type F	A
				CL	0.026	Type C	G
				CL	0.026	Type F	A
				CH	0.009	Type F	H
				SC	0.022	Type F	J
				SC	Peaty	Type F	J
				SC	0.019	Type F	K
Turkey Range (tu)	2 to 10	Group C Group B Group C/D	none	SM	0.021	Type F	J
				SC	0.008	Type F	J
				SC	Peaty	Type F	J
				SC	0.007	Type C	I
				SC	0.026	Type C	C
				CL	0.023	Type F	A
				SC-CL	0.027	Type F	C
CH	0.022	Type D	A				
Windy Creek (wc)	<3	Group C/D Group C Group C/D	none	CH	0.053	Type F	H
				CH	0.055	Type F	H
				CL	>0.064	Type F	K
				CH	0.044	Type F	H
				CH	0.048	Type F	H
				CH	0.022	Type D	H
				CH	0.007	Type D	H
				CH	0.015	Type F	H
				CH	0.028	Type D	H
				CH	0.020	Type F	H
				CH	0.014	Type D	H
				CH	0.008	Type F	H
				CL	0.044	Type F	K
CH	0.021	Type F	H				
Warung (wg)	1 to 10	Group B/C Group B/C Group B Group B/C	none	OL	Peaty	Type F	J
				OL	Peaty	Type F	J
				OL	Peaty	Type F	J
				SM	Peaty	Type F	J
				CL	0.024	Type F	C
				CL	0.016	Type F	C
				CH	0.015	Type F	C
				CL	0.011	Type F	C
				SM	0.020	Type F	K
				GM	0.036	Type C	I
Yarraman (ya)	<1	Group C Group C/D	none	CH	0.037	Type F	H
				CH	0.050	Type F	H
				CH	0.020	Type F	H
				CH	0.022	Type F	F
				CH	0.028	Type D	H
CH	0.028	Type D	G&F				
Yarramoor (ym)	<3	Group C	none	OL	0.027	Type F	J
				SM-ML	0.025	Type F	J

Table C10. Blackville Soil Landscapes (continued)

Table C10 Blackville Soil Landscapes							
Soil landscape	Slope range (%)	Soil hydrologic group	Acid Sulfate Risk	USCS Class	K-factor USLE	Sediment type	Sediment basin wall construction (earth)
				OL	0.035	Type F	J
				CL	0.028	Type F	K
				CL	0.026	Type F	K
				CL	0.040	Type F	K
				CL	0.035	Type F	K
				OL	0.015	Type F	J
				SC	0.044	Type F	K
				CL	0.037	Type F	H

Table C11. Murrurundi Soil Landscapes

Table 11 Murrurundi Soil Landscapes							
Soil landscape	Soil hydrologic group	Percent area of high acid sulfate soil risk	Acid sulfate risk	USCS Class	K-factor USLE (t.ha.h/ha.MJ.mm)	Sediment type	Sediment basin wall construction (earth)
Ant Hill (ah)	Type C/D	0.00	none	OL	0.026	Type F	J
				CH	0.020	Type D	H
				SC	0.039	Type F	A
	Type C			PT	Peaty	Type F	J
				OL	Peaty	Type F	J
				CL	0.029	Type F	H
				CL	0.029	Type D	H
				OL	0.013	Type D	J
				CH	0.019	Type D	H
				SP-ML	0.029	Type F	K
	Type C/D			CH	0.020	Type D	J
				CH	0.018	Type D	H
				CH	0.018	Type D	H
				Basin Gully (ba)	0.00	none	SM
ML		0.034	Type D				B
SP-ML	0.031	Type D	J/B				
Type C	SC	0.019	Type F				J
	SC	0.028	Type F				B
	SC	0.020	Type C				I
Type D	CL	0.034	Type F				G
	SM	0.014	Type F				J
Type C	SM	0.025	Type F				B&I
	OL	0.030	Type F				J
Type C/D	SM	0.034	Type F	B&I			
	CL	0.022	Type F	J			
Type C/D	MH	0.048	Type F	H			
	CL	0.017	Type F	J			
	CL	0.022	Type D	H			
	CL	0.026	Type F	H			
Borambil Creek (bc)	Type C/D	0.00	none	ML	0.033	Type F	J
				ML	0.040	Type F	J
				CL	0.028	Type F	G
	Type C/D			CL	0.040	Type F	J
				CL	0.043	Type D	B
	Type C			CH	0.017	Type D	J
				CL	0.019	Type D	E
	Type B			ML	0.043	Type F	J
				SM	0.032	Type F	B&I
				SM	0.025	Type F	B&I
				SM	0.049	Type F	I
	Type C			CL	0.035	Type F	J
				ML	0.034	Type F	K
Braefield (bf)	Type B/C	0.00	none	ML	0.049	Type D	J
				SC	0.027	Type F	I
				CL	0.032	Type D	B
	Type B			SC	0.010	Type C	J
				ML	0.052	Type D	D
				CL	0.016	Type D	B
				SM	0.030	Type F	J
				SM	0.027	Type F	J
				SM	0.037	Type F	B&I
				SP-ML	0.039	Type F	J/B
				SM	0.034	Type F	J
Burning Mountain (bm)	Type B/C	0.00	none	ML	0.035	Type F	J
				SP-ML	0.048	Type F	J/B
				CL	0.034	Type F	A
				SP-CL	0.035	Type F	I/A

Table C11. Murrurundi Soil Landscapes (continued)

Table 11 Murrurundi Soil Landscapes											
Soil landscape	Soil hydrologic group	Percent area of high acid sulfate soil risk	Acid sulfate risk	USCS Class	K-factor USLE (t.ha.h/ha.MJ.mm)	Sediment type	Sediment basin wall construction (earth)				
Bow (bw)	Type D	0.00	none	ML	0.037	Type F	J				
				ML	0.043	Type D	B				
				CL	0.038	Type D	B				
	Type C/D			ML	0.035	Type D	J				
				ML	0.042	Type D	D				
	Type D			CL	0.022	Type D	A				
				SM	0.035	Type F	J				
	Bow (bw)			Type C	0.00	none	SP-ML	0.040	Type D	J/B	
							OL	0.029	Type F	J	
							CH	0.028	Type D	H	
				Type C/D			CL	0.034	Type F	H	
							CH	0.044	Type F	H	
							CH	0.022	Type D	J	
				Type C/D			CL	0.023	Type D	H	
							CL	0.027	Type D	H	
OL		0.029	Type F				J				
Type C		CL	0.033	Type F			G				
		ML	0.051	Type F			A				
		CL	0.031	Type F			J				
		CL	0.040	Type F			K				
		CL	0.039	Type F			K				
		OL	0.022	Type F			J				
Type C/D	CL	0.034	Type F	G							
	CL	0.043	Type F	H							
	OL	0.021	Type F	J							
	Cooper Bulga (cb)	Type C/D	0.00	none	OL	0.018	Type F	J			
					OL	0.031	Type F	J			
					SM	0.026	Type F	K			
Type C		SP-OL			0.017	Type F	J				
		CH			0.028	Type D	H				
Type C/D		ML			>0.057	Type F	J				
	ML	0.042			Type F	A					
Type B/C	PT	Peaty			Type F	J					
	ML	0.031			Type F	A					
Currabubula Creek (cc)	Type B	0.00			none	ML	0.043	Type F	J		
						SP-CL	0.054	Type F	V/C		
						SC	0.037	Type F	A		
	Type C/D					SM	0.036	Type F	J		
						ML	0.045	Type D	A		
						PT	Peaty	Type F	J		
	Type C		CL	0.021		Type D	H				
			CL	0.020		Type F	H				
			ML	0.037		Type F	J				
			SP-CL	0.034		Type F	V/C				
			SM	0.041		Type F	I				
			ML	0.031		Type F	J				
Type B	ML		0.044	Type F		A					
	ML		0.042	Type F		A					
	Conadilly (cd)		Type C/D	0.00		none	CH	0.018	Type D	J	
		CH			0.019		Type D	F			
		OL			0.018		Type D	J			
		Type B/C	CH		0.020		Type D	F			
Cressfield Road (cf)			Type B/C		0.00		none	GM	0.033	Type C	J
								SM	0.044	Type C	J
	CL	0.021						Type F	A		
	Type C/D	SM	0.034					Type F	J		

Table C11. Murrurundi Soil Landscapes (continued)

Table 11 Murrurundi Soil Landscapes							
Soil landscape	Soil hydrologic group	Percent area of high acid sulfate soil risk	Acid sulfate risk	USCS Class	K-factor USLE (t.ha.h/ha.MJ.mm)	Sediment type	Sediment basin wall construction (earth)
				CL	0.022	Type D	G
				CL	0.021	Type D	G
	Type C/D			SM	0.042	Type F	J
				SP-CL	0.024	Type D	K/G
	Type B			SP-ML	0.042	Type F	J
				SM	0.052	Type F	J
				CL	0.033	Type D	D
				SM	0.024	Type F	J
	Type B/C			SM	0.046	Type F	J
				SM	0.037	Type F	J
				SM	0.041	Type F	I
				CL	0.028	Type D	B
Donalds Gully (dn)	Type B	0.00	none	SM	0.039	Type F	J
				SP-ML	0.060	Type D	J/E
				ML	0.084	Type F	C
	Type B/C			SM	0.043	Type F	J
				SM	0.052	Type F	J
	Type D			GC	0.022	Type F	B
				ML	0.056	Type F	J
				MH	0.065	Type D	B
				CH	0.025	Type D	G
Dunover (do)	Type C	0.00	none	CL	0.019	Type F	J
				CH	0.021	Type D	H
				CH	0.021	Type D	H
				OL	0.024	Type D	J
				CL	0.023	Type D	H
				CL	0.021	Type D	H
Dunwell (dw)	Type D	0.00	none	ML	0.032	Type F	J
				SM	0.031	Type F	B&I
	Type C/D			SM	0.034	Type F	J
				ML	0.034	Type F	A
				CL	0.037	Type D	B
	Type C/D			SM	0.045	Type F	J
				CL	0.026	Type D	D
	Type B			SM	0.026	Type F	J
				GC	0.033	Type C	I
				SM	0.032	Type D	J
				GW-SM	0.030	Type C	J
				SM	0.050	Type F	J
Galla Gilla (gg)	Type C/D	0.00	none	OL	0.033	Type F	J
				CL	0.029	Type F	H
				SM	0.050	Type F	I
				CL	0.028	Type F	H
	Type C			OL	0.029	Type F	J
				CL	0.033	Type F	G
				SM	0.041	Type F	K
	Type C/D			OL	0.020	Type D	J
				CH	0.018	Type D	H
Girds Hill (gh)	Type C/D	0.00	none	OL	0.021	Type F	J
				CH	0.026	Type D	G
				ML	0.034	Type F	J
				CL	0.027	Type D	A
				OL	Peaty	Type F	J
				ML	0.038	Type F	A
				SM	0.035	Type F	B&I

Table C11. Murrurundi Soil Landscapes (continued)

Table 11 Murrurundi Soil Landscapes											
Soil landscape	Soil hydrologic group	Percent area of high acid sulfate soil risk	Acid sulfate risk	USCS Class	K-factor USLE (t.ha.h/ha.MJ.mm)	Sediment type	Sediment basin wall construction (earth)				
Glen Oak (gk)	Type C/D	0.00	none	PT	Peaty	Type F	J				
				OL	0.020	Type D	J				
				CL	0.021	Type D	H				
				CL	0.018	Type D	H				
				OL	0.017	Type F	J				
				SP-ML	0.028	Type F	K				
				CL	0.020	Type D	J				
				CL	0.025	Type F	H				
				CL	0.026	Type F	H				
Goscombes Road (go)	Group B	0.00	none	SM	0.025	Type F	J				
				SM	0.031	Type F	B&I				
				SM	0.023	Type F	B&I				
				OL	0.020	Type F	J				
				CL	0.086	Type F	H				
				SP-CL	0.073	Type F	I/C				
				OL	0.019	Type D	J				
				CL	0.026	Type D	H				
CL	0.018	Type D	H								
Gaspard Road (gr)	Group C	0.00	none	ML	0.039	Type F	J				
				ML	0.041	Type D	A				
				CL	0.030	Type D	H				
				CL	0.030	Type D	H				
	Group C/D			ML	0.040	Type F	J				
				CL	0.018	Type D	H				
	Group C			CH	0.022	Type F	J				
				CL	0.024	Type D	H				
ML	0.027	Type D	K								
Gateleys Mountain (gt)	Group C/D	0.00	none	OL	0.043	Type F	J				
				SP-ML	0.029	Type F	J				
				CL	0.038	Type F	G				
				GP-SM	0.040	Type F	J				
				GP-SM	0.041	Type F	I/B&I				
	Group C			ML	0.033	Type F	J				
				ML	0.047	Type F	A				
	Group D			ML	0.016	Type F	J				
				Kangaroo Ridge (ka)	Group C/D	0.00	none	SM	0.027	Type F	J
								SC	0.022	Type F	B
Group B/C	ML	0.033	Type F		J						
	Group B	SM	0.028		Type F			J			
SM	0.036	Type F	B&I								
Group C	ML	0.032	Type F		J						
	CL	0.024	Type D		G						
Group C/D	OL	0.019	Type F		J						
	CH	0.030	Type F		H						
	CH	0.033	Type F		H						
	SC	0.024	Type F	J							
Group C	SC	0.029	Type F	B							
	SC	0.026	Type F	B							
	Group B/C	SM	0.039	Type F	J						
		SM	0.039	Type F	J						
SM		0.039	Type F	J							
Kingdon Ponds (kp)	Group C	0.00	none	SM	0.016	Type F	J				
				SM	0.035	Type F	B&I				
				ML	0.049	Type F	A				
	Group C			SM	0.000	Type C	J				
				SP-SM	0.038	Type F	J				
				CL	0.030	Type F	G				

Table C11. Murrurundi Soil Landscapes (continued)

Table 11 Murrurundi Soil Landscapes							
Soil landscape	Soil hydrologic group	Percent area of high acid sulfate soil risk	Acid sulfate risk	USCS Class	K-factor USLE (t.ha.h/ha.MJ.mm)	Sediment type	Sediment basin wall construction (earth)
Lever Gully (lg)	Group C/D	0.00	none	OL	0.032	Type F	J
				ML	0.040	Type D	A
				CL	0.026	Type D	H
	Group B/C			SP-OL	0.022	Type F	J
				CL	0.040	Type F	H
				CL	0.024	Type F	J
	Group C			CH	0.018	Type D	H
				CL	0.025	Type F	H
				CH	0.019	Type D	J
Group B	CL	0.017	Type F	H			
	CL	0.021	Type D	H			
	OL	0.022	Type F	J			
	SC	0.038	Type F	K			
	CH	0.037	Type F	H			
Langs Neck (ln)	Group D	0.00	none	OL	0.029	Type F	J
				ML	0.034	Type F	A
	Group C/D			PT	Peaty	Type F	J
				CL	0.024	Type D	H
				CH	0.019	Type D	H
	Group C			PT	Peaty	Type F	J
				ML	0.044	Type F	A
				SM	0.028	Type F	J
				SC	0.026	Type F	K
				Moan (mn)	Type D	0.00	none
CL	0.033	Type F	G				
Type C/D	OL	Peaty	Type F		J		
	CL	0.033	Type F		H		
Type C	ML	0.044	Type F		A		
	OL	0.019	Type F		J		
	CL	0.028	Type D		H		
Type C/D	CL	0.020	Type F		H		
	CL	0.027	Type F		J		
Miranee Road (mr)	Group B	0.00	none		SM		
				SM	0.050	Type F	J
				CL	0.031	Type D	B
	Group C			OL	0.026	Type F	J
				SC	0.036	Type F	C
				SC	0.031	Type F	B
	Group D			SM	0.021	Type F	J
				GP-SM	0.034	Type C	I
	Group C/D			ML	0.038	Type F	J
				ML	0.045	Type F	A
				CH	0.027	Type D	G
	Group D			SM	0.025	Type F	J
				SC	0.034	Type D	B
	Group C/D			SC	0.021	Type F	J
				GP-SC	0.031	Type F	K/A
SC		0.034	Type F	A			
Phillips Creek (pc)	Group C	0.00	none	OL	0.023	Type F	J
				CL	0.037	Type F	G
				CL	0.035	Type F	H
				CL	0.032	Type F	G
				CH	0.030	Type F	H
				SC	0.031	Type F	J
				ML	0.034	Type F	K

Table C11. Murrurundi Soil Landscapes (continued)

Table 11 Murrurundi Soil Landscapes							
Soil landscape	Soil hydrologic group	Percent area of high acid sulfate soil risk	Acid sulfate risk	USCS Class	K-factor USLE (t.ha.h/ha.MJ.mm)	Sediment type	Sediment basin wall construction (earth)
				CL	0.030	Type F	H
				SC	0.024	Type F	J
				CL	0.034	Type F	H
				ML	0.040	Type F	K
Parnell (pl)	Group C/D	0.00	none	ML	0.040	Type D	B
Pages River (pr)	Group B	0.00	none	ML	0.050	Type F	J
				ML	0.052	Type F	J
				ML	0.056	Type F	C
				ML	0.052	Type F	J
				ML	0.059	Type F	A
	Group C			ML	0.043	Type F	J
				SM	0.036	Type F	I
				ML	0.043	Type F	A
	Group C			ML	0.036	Type F	J
				ML	0.053	Type F	A
				CL	0.048	Type F	H
	Group C			OL	0.039	Type F	J
				CL	0.038	Type D	G
Parkville (pv)	Group B	0.00	none	ML	0.041	Type F	J
				ML	0.049	Type F	A
				CL	0.016	Type D	H
	Group B/C			ML	0.034	Type F	J
				ML	0.038	Type F	C
				CL	0.024	Type D	B
	Group C/D			ML	0.032	Type F	J
				SP-ML	0.039	Type F	I/A
	Group B			SP-ML	0.043	Type F	J
				SM	0.023	Type F	I
	Group B/C			ML	0.036	Type F	J
				SM	0.055	Type F	J
				CL	0.031	Type D	B
Quirindi Creek (qc)	Group C	0.00	none	ML	0.039	Type F	A
				ML	0.043	Type F	A
				CL	0.022	Type D	H
				CL	0.041	Type F	B
Quipolly (qu)		0.00	none	SC	0.027	Type F	B
				CL	0.021	Type D	H
	Group D			ML	0.042	Type F	J
				SM	0.027	Type F	J
				PT	Peaty	Type F	J
				SM	0.036	Type D	J
	Group C			OL	0.020	Type D	J
				CL	0.029	Type F	H
Round Hill (rh)	Group C/D	0.00	none	SM	0.033	Type D	J
				CL	0.024	Type D	B
				OL	0.038	Type F	J
				ML	0.045	Type F	A
				CH	0.019	Type D	H
	Group D			OL	0.018	Type D	J
				ML	0.035	Type D	B
				ML	0.039	Type D	E
				CL	0.022	Type D	G
	Group D			OL	0.021	Type F	J
				ML	0.045	Type D	B
				CL	0.024	Type D	B

Table C11. Murrurundi Soil Landscapes (continued)

Table 11 Murrurundi Soil Landscapes							
Soil landscape	Soil hydrologic group	Percent area of high acid sulfate soil risk	Acid sulfate risk	USCS Class	K-factor USLE (t.ha.h/ha.MJ.mm)	Sediment type	Sediment basin wall construction (earth)
				OL	0.022	Type F	J
				CL	0.041	Type F	B
				PT	Peaty	Type F	J
				ML	0.033	Type F	A
	Group C/D			PT	Peaty	Type F	J
				ML	0.049	Type F	A
Stafford Gap (sg)	Group C	0.00	none	SM	0.025	Type F	J
				SM	0.022	Type F	I
				SP-ML	0.026	Type F	J
				SM	0.034	Type C	J
				SM	0.027	Type F	I
	Group B			SM	0.014	Type F	J
				SM	0.023	Type F	B&I
	Group C			GM	0.026	Type F	J
				GP-SM	0.037	Type F	I
				SM	0.031	Type F	J
				SM	0.029	Type F	I
				SM	0.023	Type F	J
				SC	0.028	Type F	B
				SM	0.037	Type F	I
Sylphs Mountain (sm)	Group C/D	0.00	none	ML	0.032	Type F	J
				CL	0.029	Type F	G
				ML	0.037	Type F	J
				CL	0.033	Type F	G
	Group C			OL	0.025	Type F	J
				CL	0.038	Type F	G
				ML	0.049	Type F	A
	Group B/C			CH	0.039	Type F	J
				CH	0.045	Type F	H
				SP-ML	0.033	Type F	K/A
				SM	Peaty	Type F	J
Scotts Creek Road (so)	Group C/D	0.00	none	OL	0.017	Type F	J
				CH	0.022	Type D	H
				CH	0.026	Type D	H
	Group C/D			OL	0.023	Type F	J
				CL	0.029	Type F	G
				CL	0.032	Type F	G
	Group B/C			OL	0.024	Type F	J
				CH	0.044	Type F	H
				SC	0.023	Type F	A
				SM	0.013	Type F	J
				SM	0.039	Type F	J
Slippery Rock (sr)	Group C/D	0.00	none	OL	0.034	Type F	J
				ML	0.061	Type D	I
				ML	0.059	Type D	B
	Group D			SM	0.041	Type F	J
				CH	0.019	Type D	H
	Group C/D			SM	0.029	Type F	J
				SM	0.023	Type F	I
				SC	0.022	Type F	B
				SM	0.041	Type F	J
				CL	0.026	Type F	G
				CL	0.026	Type F	G
				OL	0.019	Type F	J
				CL	0.029	Type F	A
				CH	0.018	Type D	H

Table C11. Murrurundi Soil Landscapes (continued)

Table 11 Murrurundi Soil Landscapes							
Soil landscape	Soil hydrologic group	Percent area of high acid sulfate soil risk	Acid sulfate risk	USCS Class	K-factor USLE (t.ha.h/ha.MJ.mm)	Sediment type	Sediment basin wall construction (earth)
Thompsons Creek (tc)	Group B	0.00	none	ML	0.032	Type F	J
				ML	0.038	Type F	A
	Group B/C			CL	0.024	Type D	J
				CL	0.035	Type F	B
	Group B			OL	0.042	Type F	J
				ML	0.049	Type F	A
	Group B/C			SM	0.035	Type F	J
CH		0.029	Type F	H			
CL	0.031	Type F	H				
	Tinagroo (tg)	Group D	0.00	none	SM	0.021	Type F
GC					0.039	Type C	I
GW-SM		0.019			Type C	J	
Group B		SM			0.020	Type F	J
		SM			0.033	Type F	I
Thunderbolts Mountain (th)	Group C	0.00	none	SM	0.040	Type F	B&I
				SP-ML	0.046	Type F	J/B
				OL	0.022	Type F	J
				CL	0.039	Type D	B
				CH	0.025	Type D	G
	Group C/D			SM	0.016	Type C	J
				SM	0.022	Type F	J
				CH	0.022	Type D	D
	Group B/C			CH	0.024	Type D	D
				SM	0.037	Type F	J
				SM	0.038	Type F	J
	Group B			SM	0.029	Type F	J
				SM	0.024	Type F	B&I
	Group C/D			SC	0.040	Type F	B
				CL	0.022	Type D	G
SM		0.024	Type F	J			
SM		0.036	Type F	J			
Windy Creek (wc)		Group C/D	0.00	none	CH	0.017	Type D
	CH				0.022	Type D	F
	CH				0.022	Type D	H&F
	Group C	OL			0.033	Type F	J
		CH			0.023	Type D	E
	Group B/C	ML			0.040	Type F	J
		CH			0.020	Type D	H
		CH			>0.091	Type F	H
	Group C	OL			0.023	Type F	J
		CH			0.022	Type F	H
		CH			0.024	Type F	H
	Group B	OL			0.024	Type D	J
		CH			>0.084	Type F	H
		SC			0.033	Type F	K
	Warrah (wh)	Group C			0.00	none	CL
CH			0.023	Type F			H
CL			0.023	Type F			J
CH			0.019	Type D			H
CH			0.020	Type F			H
ML			0.021	Type F			J
CL			0.024	Type F			H
CL			0.046	Type F			H
Wangarang (wn)	Group C	0.00	none	OL	0.027	Type F	J
				ML	0.044	Type F	A
				ML	0.044	Type F	A

Table C11. Murrurundi Soil Landscapes (continued)

Table 11 Murrurundi Soil Landscapes							
Soil landscape	Soil hydrologic group	Percent area of high acid sulfate soil risk	Acid sulfate risk	USCS Class	K-factor USLE (t.ha.h/ha.MJ.mm)	Sediment type	Sediment basin wall construction (earth)
	Group C/D			ML	0.039	Type F	J
				CL	0.034	Type F	A
				CL	0.034	Type F	J
				SP-CL	0.033	Type F	I/A
				CL	0.036	Type F	G
Willow Tree (wt)	Group C/D	0.00	none	CL	0.022	Type F	J
				CH	0.019	Type F	H
	Group B			SM	0.027	Type F	J
				ML	0.042	Type D	B
	Group D			ML	0.007	Type F	J
	Group C/D			OL	0.019	Type F	J
				CL	0.023	Type D	H
Wingen Maid (wx)	Group D	0.00	none	SP-OL	0.012	Type F	J
				SM	0.012	Type F	J
				SM	0.027	Type C	I
				SM	0.035	Type C	I
				SM	0.014	Type F	J
				SM	0.027	Type F	J
				GP-SM	0.039	Type C	J
Springvale (sp)	Group C/D	0.00	none	OL	0.013	Type F	J
				CH	0.019	Type F	H
				CL	0.036	Type F	G
	Group D			GP-SM	0.044	Type F	J
				GP-SM	0.049	Type F	nt
	Group C			ML	0.046	Type D	J
				CH	0.030	Type D	F
	Group D			ML	0.044	Type F	J
				PT	Peaty	Type F	J
				SM	0.033	Type F	B&I
Yarramoor (ym)	Group C	0.00	none	ML	0.033	Type F	J
				CL	0.028	Type F	J
				OL	0.026	Type F	J
				CL	0.034	Type F	G
				CL	0.034	Type F	K
				CH	0.032	Type F	H
				CL	0.039	Type F	H
	Group C/D			CL	0.028	Type F	J
				GC	0.029	Type C	J
				SP-CL	0.031	Type F	J

Table C12. Dungog Soil Landscapes

Table 12 Dungog Soil Landscapes						
Soil landscape	Soil hydrologic group	Acid sulfate risk	USCS class	K-factor USLE (t.ha.h/ha.MJ.mm)	Sediment type	Sediment basin wall construction (earth)
Bonnington (bn)	Group B/C	none	ML	0.036	Type F	J
			ML	0.039	Type F	A
	Group D		ML	0.034	Type F	A
			CH	0.029	Type D	A
Barrington River (ba)	Group B	none	OL	0.031	Type F	J
	Group B/C		ML	0.043	Type F	A
			OL	0.018	Type F	J
	Group B		ML	0.048	Type F	A
			SM	0.035	Type F	I
	SM		0.038	Type F	I	
Black Camp Creek (bc)	Group C	none	ML	0.053	Type D	J
			SM-ML	0.063	Type D	J/E
			CL	0.049	Type D	D
Berrico (bo)	Group B	none	OL	0.023	Type F	J
			GM	0.047	Type F	B&I
			ML	0.049	Type D	B
			ML	0.051	Type D	B
	Group B		ML	>0.048	Type F	J
			ML	0.051	Type F	A
	Group B/C		OL	0.041	Type F	J
			ML	0.059	Type D	B
			CL	0.033	Type D	B
			OL	0.025	Type F	J
	Group B/C		ML	0.039	Type D	A
			CL	0.020	Type D	A
			CL	0.019	Type D	A
Bucketts Road (bu)	Group B/C	none	OL	0.045	Type F	J
			ML	0.062	Type D	D
			CH	0.026	Type D	G
			GC	0.040	Type D	D
	Group B/C		ML	0.046	Type F	J
			ML	0.060	Type F	I
			CL	0.035	Type D	B
	Group C		ML	0.056	Type F	I
			ML	0.060	Type F	A
			CL	0.032	Type D	B
	Group C		OL	0.029	Type F	J
			CL	0.023	Type D	H
			SC	0.015	Type D	nt
Cockadilly Ridge (cd)	Group C/D	none	ML	0.038	Type F	J
			SM	0.048	Type D	J
	Group B		OL	0.025	Type F	J
			ML	0.036	Type F	A
			CL	0.040	Type D	A
			CL	0.031	Type D	B
	Group C		SM-ML	0.031	Type F	J
			SM	0.043	Type D	J
	Group C		ML	0.038	Type F	A
			CH	0.027	Type D	G
Chichester (ci)	Group B	none	PT	Peaty	Type F	J
			CL	>0.072	Type F	C
	Group B		OL	0.031	Type F	J
			ML	0.036	Type F	A

Table C12. Dungog Soil Landscapes (continued)

Table 12 Dungog Soil Landscapes						
Soil landscape	Soil hydrologic group	Acid sulfate risk	USCS class	K-factor USLE (t.ha.h/ha.MJ.mm)	Sediment type	Sediment basin wall construction (earth)
			ML	0.046	Type F	B
	Group B/C		ML	0.031	Type F	A
			ML	0.040	Type F	A
			SM-ML	0.023	Type F	B&I/A
			SM	0.043	Type F	J
	Group B/C		OL	Peaty	Type F	J
			CL	0.029	Type F	G
			CL	0.064	Type F	C
	Group C		CL	0.021	Type F	A
			CL	0.022	Type F	A
			ML	>0.078	Type F	C
			ML	>0.087	Type F	C
			ML	>0.087	Type F	C
	Group C		OL	Peaty	Type F	J
			OL	0.028	Type F	J
			ML	0.031	Type F	A
Craven (cn)	Group D	none	SM	0.039	Type F	J
			ML	0.064	Type F	B
			ML	0.037	Type D	B
			CL	0.036	Type D	D
Chichester River (cr)	Group C/D	none	ML	0.050	Type D	A
			ML	0.052	Type D	B
			CL	0.051	Type D	D
Dungog (du)	Group D	none	OL	0.027	Type F	J
			ML	0.048	Type D	D
	Group C/D		SM-ML	0.043	Type F	J
			SM	0.056	Type F	J
			CL	0.045	Type D	D
Gloucester Buckets (gb)	Group B	none	SM-ML	0.037	Type F	B&I/A
			SM-ML	0.030	Type F	J
			SM-ML	0.043	Type D	J/D
			SM	0.037	Type F	J
	Group C/D		GM	0.031	Type F	B&I
			SM-ML	0.046	Type F	J
			ML	0.058	Type F	B
			CL	0.042	Type D	B
			ML	Peaty	Type D	J
			ML	0.048	Type D	B
Gresford (gd)	Group C	none	SM	0.044	Type F	J
			SM	0.051	Type F	J
			CL	0.031	Type D	A
	Group D		ML	0.038	Type F	J
			SM	0.039	Type F	J
Gilmore Hill (gi)	Group C	none	ML	0.039	Type D	J
			CL	0.037	Type F	B
			CL	0.037	Type F	A
Gloucester (go)	Group C/D	none	ML	0.045	Type F	J
			ML	0.052	Type D	B
			CL	0.029	Type D	B
			CH	0.023	Type D	G&F
Gloucester River (gu)	Group C/D	none	SM	0.039	Type F	J
			SM	0.056	Type F	J
			SC	0.035	Type D	B

Table C12. Dungog Soil Landscapes (continued)

Table 12 Dungog Soil Landscapes						
Soil landscape	Soil hydrologic group	Acid sulfate risk	USCS class	K-factor USLE (t.ha.h/ha.MJ.mm)	Sediment type	Sediment basin wall construction (earth)
Gloucester Tops (gp)	Group C	none	ML	0.044	Type F	J
			SM	0.047	Type D	J
	Group C		PT	Peaty	Type F	J
			OL	Peaty	Type F	J
	Group B		OL	0.012	Type F	J
			OL	0.020	Type F	J
			CL	0.052	Type F	C
			ML	0.059	Type F	C
	Group C		ML	0.061	Type F	C
			OL	0.022	Type F	J
			CL	0.045	Type F	C
	Group C		ML	0.059	Type F	C
			PT	Peaty	Type F	J
			SP	0.019	Type C	I
Group C/D		SM	0.015	Type F	I	
		ML	0.022	Type F	C	
		ML	0.079	Type F	C	
Lame Cow Gully (lc)	Group C	ML	0.050	Type D	J	
		ML	0.055	Type D	B	
		CH	0.029	Type D	G	
Linger and Die (ld)	Group B/C	OL	0.014	Type F	J	
		ML	0.045	Type D	D	
		OL	0.023	Type F	J	
	Group C	SM-ML	0.040	Type D	D	
		SM-ML	0.024	Type F	J	
		SM	0.037	Type F	J	
		SM	0.029	Type F	J	
Karuah River (kr)	Group B/C	SM	0.050	Type F	J	
		ML	0.048	Type F	I	
		ML	0.044	Type F	B	
	Group C/D	SM	0.036	Type F	B&I	
		ML	0.051	Type F	J	
		ML	0.057	Type D	A	
Lawlers Range (lr)	Group D	CL	0.038	Type D	B	
		ML	0.028	Type D	J	
Marshdale (ma)	Group D	SM-ML	0.031	Type D	J/B	
		ML	0.041	Type F	J	
		ML	0.066	Type D	E	
	Group B	CL	0.035	Type D	D	
		SM	0.021	Type F	J	
SM	SM	0.039	Type D	J		
	Lame Cow Gully variant a (lca)	Group C	ML	0.051	Type D	J
ML			0.054	Type D	B	
CL			0.028	Type D	G	
Group D		GM	0.043	Type F	J	
		ML	0.056	Type D	B	
		CL	0.041	Type F	A	
Monkerai (mo)	Group D	SM-ML	0.026	Type F	J	
		ML	0.043	Type F	B	
	Group D	OL	0.027	Type F	J	
		ML	0.047	Type F	B	
		CL	0.033	Type F	G	

Table C12. Dungog Soil Landscapes (continued)

Table 12 Dungog Soil Landscapes							
Soil landscape	Soil hydrologic group	Acid sulfate risk	USCS class	K-factor USLE (t.ha.h/ha.MJ.mm)	Sediment type	Sediment basin wall construction (earth)	
	Group C/D		OL	0.028	Type F	J	
			OL	0.034	Type F	J	
			CL	0.021	Type D	A	
Paterson River (pa)	Group B/C	none	ML	0.045	Type F	I	
			ML	0.068	Type F	C	
	Group B	SM	0.041	Type F	I		
		SM	0.037	Type F	I		
	Group B	ML	0.035	Type F	J		
		ML	0.045	Type F	A		
ML	0.058	Type F	C				
Salisbury (sa)	Group C	none	ML	0.050	Type F	J	
			ML	0.046	Type D	A	
			ML	0.057	Type F	A	
	Group B	ML	0.043	Type F	J		
		ML	0.040	Type F	A		
Saw Pit Creek (sp)	Group C/D	none	OL	>0.040	Type F	J	
			ML	>0.070	Type D	D	
			CL	0.040	Type D	E	
			CL	0.037	Type D	E	
	Group C/D	OL	Peaty	Type F	J		
		ML	0.044	Type F	B		
		CH	0.021	Type D	G		
	Group D	OL	0.017	Type F	J		
		ML	0.050	Type D	D		
	Group C/D	OL	0.026	Type F	J		
		SM-ML	0.047	Type F	J/B		
		CL	0.030	Type D	B		
	Stroud Road (sr)	Group C	none	CL	0.036	Type F	B
				ML	0.048	Type D	A
Group C		OL	0.030	Type F	J		
		SC	0.022	Type D	K		
		CL	0.038	Type D	B		
Group C		OL	0.019	Type F	J		
		CH	0.056	Type F	C		
		CH	0.041	Type F	C		
Group D		SP	0.022	Type F	I		
Group C/D		GM	0.045	Type F	J		
	GM	0.058	Type F	J			
Tillegra (ti)	Group C	none	ML	0.036	Type F	J	
			SM	0.038	Type D	J	
			ML	0.057	Type D	I	
	Group C/D	CL	0.037	Type D	B		
		CL	0.044	Type F	D		
	Group C	OL	0.025	Type F	J		
		SM-ML	0.046	Type F	J/B		
		SM-ML	0.043	Type D	J/D		
	Group D	ML	0.039	Type F	J		
		ML	0.051	Type F	B		
		CL	0.025	Type D	B		
		CL	0.043	Type D	D		
	Group D	OL	0.020	Type F	J		
		CL	0.022	Type F	A		
		CL	0.022	Type F	A		

Table C12. Dungog Soil Landscapes (continued)

Table 12 Dungog Soil Landscapes						
Soil landscape	Soil hydrologic group	Acid sulfate risk	USCS class	K-factor USLE (t.ha.h/ha.MJ.mm)	Sediment type	Sediment basin wall construction (earth)
Wards River (wd)	Group C/D	none	OL	0.035	Type F	J
			SM	0.051	Type D	J
			CH	0.019	Type D	D
			CH	0.022	Type D	B
	Group C/D		OL	0.040	Type D	J
			ML	0.051	Type D	B
			CL	0.028	Type D	B
			CL	0.040	Type D	B
	Group C		OL	0.039	Type F	J
			CL	0.032	Type D	B
	Group B/C		SM	0.030	Type F	J
			SM	0.046	Type D	J
	Williams Range (wi)		Group D	none	CL	0.024
GM		0.040			Type F	J
Group D		OL	0.017		Type F	J
		ML	0.035		Type D	B
		CL	0.025		Type D	B
Group B		ML	0.037		Type F	J
		ML	0.049		Type D	B
Group B		ML	0.028		Type D	B
		OL	0.027		Type D	J
Group D		OL	Peaty		Type F	J
		ML	0.045		Type D	D
Group B/C		ML	0.042		Type F	J
		ML	0.053		Type D	B
		CL	0.030		Type F	G
Group B/C		ML	0.033		Type F	J
		ML	0.051		Type D	B
		CL	0.022		Type D	G
Group D		OL	0.016		Type F	J
		ML	0.048		Type D	B
Group B/C		ML	0.045		Type F	J
	ML	0.052	Type D	D		
Washpool (ws)	Group C/D	none	GM	0.025	Type F	J
			GM	0.028	Type C	J
Wangat (wt)	Group D	none	OL	0.004	Type F	J
			OL	0.018	Type D	J
	Group B		OH	Peaty	Type F	J
			OL	0.016	Type F	J
	Group B		OL	0.026	Type D	J
			CL	0.034	Type D	D
			CL	>0.087	Type F	C
			CH	0.024	Type D	A
			CL	0.021	Type F	C

Table C13. Newcastle Soil Landscapes

Soil landscape	Common constraints	Slope range (%)	Soil hydrologic group	Acid sulfate risk	USCS class	K-factor USLE	Sediment type	Sediment basin wall construction (earth)
Awaba (aw)	very high erosion hazard; localised steep slopes with mass movement potential; shallow soils with low fertility	10 to 60	Group B/C	sporadic	SC SC-CM CH	0.034 0.02 0.023	Type D Type D Type D	B B A
Blind Harrys Swamp (ba)	subject to permanently high waterables and waterlogging; shallow non cohesive soils pose risks to foundations and waterable pollution	<2	Group D	endemic	PT SP	Peaty 0.026	Not tested Type F	J nt
Black Camp Creek (bc)	subject to flooding, permanent or seasonal waterlogging, high erosion hazard; localised areas of high run-on ; risks to foundations	1 to 3	Group C	sporadic	ML ML CL	0.053 0.048 0.044	Type D Type D Type D	J D B
Beresfield (be)	high soil erosion hazard; general risks of mine subsidence; localised steep slopes, high run-on, rock outcrop, seasonal waterlogging	3 to 15	Group C	sporadic	ML CH CL ML CH	0.033 0.018 0.048 0.028 0.017	Type D Type D Type F Type F Type F	B G B J C
Bobs Farm (bf)	permanently high waterable, seasonal waterlogging and flooding hazards; localised permanent waterlogging; risks to foundations	<1	Group D	endemic	OL	0.003	Type F	J
Bolwarra Heights (bh)	high erosion hazard; localised steep slopes contribute to mass movement, high run-on and waterlogging of lower slopes; localised shallow soils and rock outcrop; risks to foundations		Group C	sporadic	CH SM CL SM CH	0.025 0.033 0.028 0.045 0.022	Type D Type F Type F Type F Type F	G I A J G
Birdsview (bi)	generally steep slopes, high run-on and high erosion hazard; localised mass movement, shallow soils and rock outcrop	<45	Group D	none	SM SM SC SC CH	0.021 0.041 0.027 0.030 0.023	Type F Type D Type D Type D Type F	J J D D A
Brecon (br)	high erosion hazard; localised shallow soils; high run-on and waterlogging of lower slopes; risks to foundations	2 to 10	Group C/D	sporadic	SM CL CH	0.041 0.035 0.025	Type F Type F Type D	J J G
Boyces Track (bt)	coarse non cohesive soils with low fertility; widespread potential for wind erosion and mass movement; localised	>25	Group A	endemic	SW SW	0.000 0.000	Type C Type C	J I

Table C13. Newcastle Soil Landscapes (continued)

Soil landscape	Common constraints	Slope range (%)	Soil hydrologic group	Acid sulfate risk	USCS class	K-factor USLE	Sediment type	Sediment basin wall construction (earth)
	steep slopes; risks to foundations				SW	0.000	Type C	I
					SW	0.000	Type C	I
Cabbage Tree Mountain (cm)	steep slopes with high erosion hazard; some high run-on to low areas, rock falls, shallow soils, rock outcrop; general risks to foundations	>25	Group C	sporadic	ML-CL CL CL-ML	0.041 0.030 0.040	Type D Type D Type D	E/D D D
Cockle Creek (cc)	permanently high waterables and waterlogging in low areas; localised shallow soils; risks to foundations	<2	Group C/D	common	CH SM SC SC	0.026 0.000 0.032 0.026	Type D Type F Type F Type F	B J B B
Cedar Hill (ce)	steep landscape subject to mass movement and high erosion hazard; mine subsidence/foundation risks; localised high run-on and seasonal waterlogging of lower slopes	15 to 40	Group C	sporadic	CL CH	0.024 0.022	Type D Type D	J A
Clay Hill (ch)	steep landscapes subject to mass movement and high erosion hazards	20 to 40	Group C/D	none	OL CH ML CL	0.029 0.025 0.052 0.038	Type D Type D Type F Type D	J H D D
Clarencetown (cl)	shallow soils with high erosion hazard; localised rock outcrops; waterlogging in low areas	5 to 15	Group D	sporadic	ML SM CL	0.034 0.048 0.031	Type F Type D Type D	J J D
Doyalson (do)	high erosion and localised run-on hazards; mine subsidence and low fertility	<10	Group C/D	na	SM-SC SC CH	0.041 0.029 0.018	Type C Type C Type D	B B B
Emu Creek (ec)	high erosion hazard and mass movement associated with steep slopes, shallow soils; localised high run-on to lower areas; general risks to foundations	20 to 50	Group C	sporadic	ML-CL CH	0.021 0.023	Type D Type D	D D
Fullerton Cove (fc)	high run-on; permanently high waterables, waterlogging in low areas; localised wave erosion; foundation risks	<3	Group D	endemic	CL CL	Peaty Peaty	Type F Type F	J J
Gan Gan (gg)	steep shallow soils and rock outcrop; high erosion hazard; localised mass movement and rock falls; high run-on to low	>25	Group B	sporadic	ML-CL CL-ML	0.014 0.058	Type D Type D	J E

Table C13. Newcastle Soil Landscapes (continued)

Soil landscape	Common constraints	Slope range (%)	Soil hydrologic group	Acid sulfate risk	USCS class	K-factor USLE	Sediment type	Sediment basin wall construction (earth)
	areas; general risks to foundations;				CL	0.018	Type F	C
Gateshead (ga)	high erosion hazard; steep slopes contributing to general rock fall susceptibility, localised high run-on, waterlogging of lower areas; localised risks to foundations	<15	Group C	sporadic	PT CH GM CH CH	Peaty 0.019 0.019 0.015 0.020	Type F Type D Type F Type D Type D	J A J A A
Gilmore Hill (gi)	steep slopes, shallow soils, rock outcrop; high erosion hazards; risks to foundations	20 to 50	Group B	sporadic	SM SM CL	0.022 Peaty 0.031	Type F Type F Type D	J I B
Glenurie Hill (gl)	high erosion hazard; localised steep slopes, mass movement, shallow soils, rock outcrop, high run-on, waterlogging low areas	10 to 20	Group C/D	sporadic	SM CH SM	0.043 0.036 0.026	Type F Type D Type F	J D J
Gardiners Road (gr)	steep slopes, mass movement, high erosion hazard; localised rock fall, shallow soil, rock outcrop; foundation hazards	20 to 30	Group B	none	SM SM CL	0.038 0.049 0.035	Type F Type F Type D	J J B
George Trig (gt)	shallow soils, rock outcrop; high erosion hazard; localised waterlogging	10 to 20	Group D	none	SM ML	0.044 0.023	Type D Type D	J J
Glen William (gw)	high erosion hazard; localised shallow soils, high run-on, waterlogging lower areas; localised risks to foundations	1 to 15	Group C Group C/D	sporadic	ML CH SC PT ML CH	0.039 0.022 0.032 Peaty 0.041 0.022	Type F Type D Type D Type F Type D Type D	C B B J D G
Half Moon Brush (hb)	shallow soils, steep slopes, mass movement, high erosion hazard; localised rock outcrop and high run-on; risks to foundations	20 to 40+	Group D	none	SM ML CH OL	0.038 0.049 0.021 0.020	Type F Type D Type D Type F	J B B J
Heddon Greta (hg)	shallow non cohesive soils, localised high run-on, seasonal waterlogging in low areas; localised wind erosion hazard; localised risks to foundations	2 to 10	Group B/C	none	SM SC SC CH	0.016 0.031 0.024 0.026	Type F Type F Type F Type D	J I C G

Table C13. Newcastle Soil Landscapes (continued)

Soil landscape	Common constraints	Slope range (%)	Soil hydrologic group	Acid sulfate risk	USCS class	K-factor USLE	Sediment type	Sediment basin wall construction (earth)
Hungry Hill (hh)	steep landscape, mass movement; high erosion hazard, shallow soils, rock outcrop; localised high run-on and waterlogging low areas; risks to foundations	20 to 45	Group C/D	none	SM SC CL	0.030 0.040 0.039	Type F Type D Type D	J D G
Hilldale (hi)	localised shallow soils, high erosion hazard, high run-on and waterlogging in low areas	5 to 15	Group C	none	SM CL CL	0.038 0.026 0.025	Type D Type F Type D	J J B
Hamilton (hm)	coarse non cohesive soils; high wind erosion hazard; localised areas of high run-on, waterlogging; localised risks to foundations and watertable pollution	<2	Group A	widespread	SM SM SC	0.015 0.016 0.009	Type F Type F Type F	J J I
Hawks Nest (hn)	coarse non cohesive soils; high wind erosion hazard; localised areas of permanently high watertables, waterlogging; localised risks to foundations and watertable pollution	<10	Group A	endemic	SW SW SW SW	0.000 0.000 0.000 0.000	Type C Type C Type C Type C	J I I I
Hexham Swamp (hs)	low-lying, high watertable, waterlogging, flood prone; localised erosion hazard; widespread risks to foundations	<1	Group D	endemic	OL CL	Peaty 0.039	Type D Type F	J A
Hunter (hu)	flood prone; localised high watertables, seasonal waterlogging and erosion hazards	<1	Group B Group C	endemic	SC CH CH SP ML ML	0.037 0.021 0.029 0.014 0.030 0.031	Type F Type D Type D Type F Type D Type D	I F D I A A
Ironstone Mountain (im)	steep slopes, mass movement; shallow soils, high erosion hazards; localised high run-on; risks to foundations	20 to 40+	Group C	none	SM SM CH	0.016 0.047 0.027	Type F Type F Type D	J J D
Killingworth (ki)	high erosion hazard; localised shallow soils, rock outcrop; high run-on, waterlogging low areas; mine subsidence, risks to foundations	3 to 20	Group C/D	sporadic	SM ML CL	0.027 0.036 0.036	Type F Type D Type D	J D B
Lower Pindimar (lp)	low-lying, sandy, non cohesive soils; permanently high watertable and seasonal waterlogging; localised areas of high run-on, permanent waterlogging and flood hazard; localised	<3	Group A/B	endemic	SP SM	0.000 0.013	Type C Type C	J I

Table C13. Newcastle Soil Landscapes (continued)

Soil landscape	Common constraints	Slope range (%)	Soil hydrologic group	Acid sulfate risk	USCS class	K-factor USLE	Sediment type	Sediment basin wall construction (earth)
	risks to foundations							
Malabula Point (mp)	high erosion hazard from steep slopes, some shallow soils, and rock outcrop on uplands; localised high run-on, seasonal waterlogging of low areas;	5 to 30	Group C/D	sporadic	ML CH	0.036 0.049	Type D Type F/D	D I
Mount Douglas (md)	localised mass movement; shallow soils, rock outcrop, water erosion hazards; risks to foundations	10 to 20	Group B		OL CH	Peaty 0.011	Type F Type D	J A
Medowvie (me)	localised shallow soils, extreme erodibility and high erosion hazard; localised risks to foundations	2 to 15	Group C/D	sporadic	SC CL CL CH MH CH CH CH	0.031 0.081 0.067 0.071 0.044 0.052 0.060 0.069	Type F Type F Type F Type F Type F Type F Type F Type F	B C C C A C C C
Millers Forest (mf)	permanently high watertables, waterlogging, flood prone; widespread risks to foundations	<1	Group C	endemic	OL CL	0.023 0.025	Type F Type D	J A
Middlehope (mi)	shallow soils, rock outcrop, high erosion hazard; localised steep slopes, mass movement and high run-on; localise foundation hazards	15 to 40	Group C/D	sporadic	SM SM CH	0.035 0.041 0.018	Type F Type F Type D	J J G
Mount Johnstone (mj)	steep slopes, mass movement, shallow soils, rock outcrop, high erosion hazard; widespread risks to foundations	>25	Group D	none	ML ML ML	0.059 0.034 0.044	Type D Type F Type D	B J B
North Eelah (ne)	high erosion hazard; localised shallow soil, rock outcrop; seasonal waterlogging of low areas	5 to 20	Group C/D	sporadic	OL OL CH SC CH CH SM SM CH	0.023 0.017 0.028 0.041 0.029 0.037 0.042 0.047 0.034	Type F Type F Type D Type F Type F Type D Type F Type F Type F Type F	J J H I H H J J G

Table C13. Newcastle Soil Landscapes (continued)

Soil landscape	Common constraints	Slope range (%)	Soil hydrologic group	Acid sulfate risk	USCS class	K-factor USLE	Sediment type	Sediment basin wall construction (earth)
Nerong Waterholes (nw)	low areas of high run-on, high watertables, seasonal waterlogging and flood hazard; some permanent waterlogging; general risks to foundations	<2	Group C/D	endemic	CH CH-MH CH	0.025 0.017 0.026	Type D Type D Type D	B J B
Norah Head (nh)	extreme wind erosion and high water erosion hazards; non cohesive highly permeable soils with very low fertility	<15	Group A	na	SP-SM SP SM	0.016 0.015 0.021	Type FC Type C Type C	J J J
Paterson River (pa)	high water erosion and flood hazard; localised non cohesive soil, wind erosion hazard; general risks to foundations	<3	Group B	sporadic	SW SW	0.025 0.026	Type F Type F	I I
North Arm Cove (nc)	generally high erosion hazard; localised areas with high run-on	<15	Group C/D	sporadic	ML-CL CH ML-CL	0.051 0.024 0.043	Type D Type F Type F	E A J
Nungra (ng)	low-lying areas of high run-on, permanently high watertables, seasonal waterlogging and flood hazards; localised risks to foundations	<3	Group C/D	sporadic	ML-CL CL-ML	>0.079 >0.093	Type D Type D	I I
Rivermead (ri)	localised shallow soils, high run-on, seasonal waterlogging, and flooding; localised erosion hazard; general risks to foundations	<4	Group B	sporadic	SC SC SC	0.031 0.025 0.027	Type F Type D Type F	J I B
River Road (rr)	generally high erosion hazard; localised steep slopes, shallow soils and rock outcrop; low areas with high run-on and seasonal waterlogging	<40	Group C/D	sporadic	OL SM CH CH	0.028 0.044 0.028 0.035	Type F Type F Type D Type D	J J D D
Shoal Bay (sb)	non cohesive soils, wind erosion hazard; localised steep slopes; general risks of watertable pollution	<15	Group A	widespread	CL-ML CL-ML CH	>0.032 0.042 0.020	Type D Type D Type D	I D A
Shoal Bay Swamp (ss)	low lying area with high run-on, permanently high watertable, permanent waterlogging and flood hazard; non cohesive materials with wind high erosion hazard; general risks to foundations	<5	Group D	endemic	SW SW SW	0.000 0.000 0.009	Type C Type C Type C	I J I

Table C13. Newcastle Soil Landscapes (continued)

Soil landscape	Common constraints	Slope range (%)	Soil hydrologic group	Acid sulfate risk	USCS class	K-factor USLE	Sediment type	Sediment basin wall construction (earth)
	foundations							
Sandy Creek (sc)	high run-on, permanently high watertable, seasonal waterlogging, flood prone; high erosion hazards; localised shallow soil; risks to foundations and watertable pollution	<1	Group B	sporadic	ML ML	0.040 0.041	Type D Type F	B A
Seaham (se)	high water and wave erosion hazards; localised high run-on and waterlogging of low areas	3 to 15	Group B Group D	sporadic	CL CH ML	0.032 0.027 0.044	Type D Type D Type F	B B J
Shamrock Hill (sh)	high erosion hazard; localised steep slopes, mass movement; shallow soils, high run-on, seasonal waterlogging in low areas; mine subsidence, risks to foundations	10 to 15	Group C	none	SM SM CL CL	0.032 0.041 0.026 0.040	Type F Type D Type D Type D	J J D D
Stockton Beach (sk)	shallow non cohesive soils; wind and wave erosion hazards; localised steep slopes, mass movement; some local high watertables and waterlogging; general risks to foundations	na	Group A	widespread	SP SP	0.009 0.011	Type C Type C	I I
Stockrington (sn)	steep slopes, mass movement and high erosion hazard; localised rock falls; localised high run-on to low areas; instances of mine subsidence	15 to 20	Group B	none	SC GP SM	0.015 0.039 0.039	Type F Type C Type D	J J J
Sugarloaf (su)	steep slopes, mass movement, rock falls, mine subsidence; serious general risks to structures; localised shallow soils and rock outcrop; high erosion hazard	>30	Group B	none	SM SM-ML CL SC	0.039 0.042 0.038 0.028	Type F Type F Type D Type D	J B&I/A D B
Tereel Ridge (tr)	generally high erosion hazard associated with steep slopes and shallow soils; localised rock outcrop and rock fall hazard; localised high run-on to low areas; general risks to foundations	>20	Group D	endemic	ML	0.032	Type F	A
The Branch (tb)	general erosion hazard, high watertables; localised high run-on and seasonal waterlogging in low areas; localised risks to foundations	<2	Group D	sporadic	OL MH CL	0.027 0.071 0.048	Type F Type F Type D	J I D
Ten Mile Road (tm)	water erosion hazard; localised shallow soil, rock outcrop; high run-on and seasonal waterlogging of low areas	5 to 10	Group C	sporadic	SM SM	0.016 0.054	Type F Type D	J J

Table C13. Newcastle Soil Landscapes (continued)

Soil landscape	Common constraints	Slope range (%)	Soil hydrologic group	Acid sulfate risk	USCS class	K-factor USLE	Sediment type	Sediment basin wall construction (earth)
Tea Gardens (tn)	permanently high watertable, seasonal waterlogging; localised non cohesive soils and wind erosion; permanent waterlogging in low areas; risks to foundations and watertable pollution	<5	Group A/B	endemic	MH SM SM SC SC SM SC	0.065 0.016 0.018 Pan 0.013 Peaty Pan	Type D Type C Type C Type C Type C Type F Type C	D J I I C J J
Tuggerah (tg)	high wind erosion hazard; highly permeable soils with very low fertility; localised flooding and high watertable hazards	1 to 10	Group B	na	SM SP-SM SP	0.009 0.016 0.006	Type C Type C Type C	I I I
Vacy (va)	localised shallow soils and rock outcrop; high run-on and seasonal waterlogging of low areas; generally high erosion hazard; localised foundation hazards	2 to 10	Group C	sporadic	ML CL CH CH ML	0.042 0.036 0.023 0.024 0.032	Type D Type D Type D Type D Type F	B D D G J
Warners Bay (wa)	localised steep slopes and mass movement potential; mine subsidence area; seasonal waterlogging on lower slopes; low fertility	3 to 20	Group B	sporadic	ML ML CH	0.037 0.059 0.027	Type D Type D Type D	J B A
Wallis Creek (wc)	non cohesive soils with high water and wind erosion hazards; flood prone; localised high watertables and waterlogging; general risks for foundations and watertable pollution	<3	Group B/C	cpmmon	ML SC OL	0.042 0.032 0.029	Type F Type F Type F	I I J
Welshmans Creek (we)	high erosion hazard; localised steep slopes, mass movement potential; rock outcrop; high run-on and seasonal waterlogging of low areas; localised risks to foundations	10 to 25	Group C	none	SC ML ML CH	0.039 0.046 0.046 0.038	Type D Type F Type D Type D	D J B D
Wallalong (wg)	localised shallow soils and rock outcrop; high run-on, high watertables and seasonal waterlogging in low areas; generally high erosion hazard; general foundation hazards	2 to 10	Group B/C	sporadic	ML SC-CL CH	0.032 0.047 0.033	Type D Type D Type D	J D F
Williams River (wr)	permanently high watertables, seasonal waterlogging; flood hazard; high erosion hazard; general risks to foundations	<3	Group B/C	frequent	ML ML	0.036 0.042	Type F Type D	A A

Table C13. Newcastle Soil Landscapes (continued)

Soil landscape	Common constraints	Slope range (%)	Soil hydrologic group	Acid sulfate risk	USCS class	K-factor USLE	Sediment type	Sediment basin wall construction (earth)
Wyong (wy)	flooding, seasonal waterlogging and localised streambank erosion hazards; localised potential for acid sulfate soils; poorly drained impermeable soils with low fertility	<3	Group D	na	SC-ML	0.028	Type F	A-B

Table 14 Port Stephens										
Soil landscape	Common constraints	Slope range (%)	Soil hydrologic group	Percent area of high acid sulfate soil risk	Acid sulfate risk	USCS class	K-factor USLE	Sediment type	Sediment basin wall construction (earth)	
Alum Mountain (am)	high erosion hazard associated with steep slopes, shallow soils and rock outcrop; localised rock fall and high run-on to lower areas; general risks to foundations	20 to 50	Group C	1.23	sporadic	MH ML-CL CH	0.004 0.046 0.020	Type F Type F Type D	J I F	
Bobs Farm (bf)	permanently high watertable, seasonal waterlogging and flooding hazards; localised permanent waterlogging; risks to foundations	<1	Group B	80.77	endemic	ML-CL CL SM	Peaty 0.056 0.019	Type F Type F Type C	J C I	
Bombah Point (bp)	shallow soils with high erosion hazard; localised rock outcrop, steep slopes, non cohesive peaty materials; occasional rock fall	<25	Group B	21.16	common	OH	Peaty	Type F	J	
Boyces Track (bt)	coarse non cohesive soils with low fertility; widespread potential for wind erosion and mass movement; localised steep slopes; risks to foundations	>25	Group A	0.84	widespread	SW SW SW ML	0.000 0.000 0.000 0.000	Type C Type C Type C Type C	J I I I	
Cabbage Tree Mountain (cm)	steep slopes with high erosion hazard; some high run-on to low areas, rock falls, shallow soils, rock outcrop; general risks to foundations	>25	Group C	0.32	sporadic	ML-CL ML-CL CL CL-ML	0.037 0.041 0.030 0.040	Type D Type D Type D Type D	J E/D D D	
Emu Creek (ec)	high erosion hazard and mass movement associated with steep slopes, shallow soils; localised high run-on to lower areas; general risks to foundations	20 to 50	Group C	0.01	sporadic	ML-CL ML-CL CH CH	0.011 0.021 0.023 0.022	Type D Type D Type D Type D	J D D D	
Eurunderee Swamp (es)	low lying sandy soils with high run-on; permanently high watertables, waterlogging, flooding hazard; high erosion hazard; general risks to foundations	<2	inapplicable	23.03	endemic	PT SW	Peaty 0.000	Not tested Type C	J J	
Fullerton Cove (fc)	high run-on; permanently high watertables, waterlogging in low areas; localised wave erosion; foundation risks	<45	Group D	90.93	endemic	PT SC SM	Peaty 0.002 0.000	Type D Type C Type C	J K J	
Fingal Head (fh)	non cohesive soils with high wind erosion hazard; low areas with high run-on, seasonal waterlogging; steeper slopes with mass movement and high water erosion hazard; localised risks to foundations	<45	Group A	0.08	sporadic	SW SW SW SW	0.000 0.000 Pan 0.017	Type C Type C Type C Type C	J I I J	
Grey Gum Creek (gc)	low area of high run-on and waterlogging; high erosion hazard; localised flooding; local risks to foundations	<5	Group C	0.00	none	ML-CL ML-CL	0.019 0.040	Type F Type D	J D	

Table C14. Port Stephens Soil Landscapes (continued)

Soil landscape	Common constraints	Slope range (%)	Soil hydrologic group	Percent area of high acid sulfate soil risk	Acid sulfate risk	USCS class	K-factor USLE	Sediment type	Sediment basin wall construction (earth)
Gan Gan (gg)	steep shallow soils and rock outcrop; high erosion hazard; localised mass movement and rock falls; high run-on to low areas; general risks to foundations;	>25	Group B	2.06	sporadic	ML-CL CL-ML CL	0.024 >0.060 0.038	Type D Type D Type D	D D
Green Hills (gh)	shallow soils and rock outcrop; localised erosion hazard; low areas of high run-on and seasonal waterlogging; general risks to foundations	5 to 15	Group B/C	0.28	sporadic	ML ML CH	0.012 0.034 0.019	Type F Type F Type D	J A G
Hawks Nest (hn)	coarse non cohesive soils; high wind erosion hazard; localised areas of permanently high watertables, waterlogging; localised risks to foundations and watertable pollution	<10	Group A	2.00	endemic	SW SW SW SW	0.005 0.000 0.001 0.000	Type C Type C Type C Type C	J I I I
Johnsons Hill (jh)	shallow soils and rock outcrop with high erosion hazard; localised areas of steep slope; localised low areas with high run-on; general risks to foundations	20 to 40	Group B/C	0.00	sporadic	PT ML-CL	Peaty 0.038	Type F Type F	J D
Lower Pindimar (lp)	low-lying, sandy, non cohesive soils; permanently high watertable and seasonal waterlogging; localised areas of high run-on, permanent waterlogging and flood hazard; localised risks to foundations	<3	Group A/B	76.64	endemic	SP SP SM SW	0.000 0.000 0.013 0.000	Type C Type C Type C Type C	J J I I
Mount George (mg)	steep slopes with high erosion hazard; localised mass movement; low areas with high run-on; general risks to foundations	20 to 60	Group C/D	0.04	sporadic	ML-CL ML-CL CL-ML MH-CH	0.016 0.030 0.055 0.017	Type F Type D Type D Type D	J B D B
Markwell Heights (mh)	high erosion hazard from generally steep slopes, shallow soils, rock outcrop on uplands; localised mass movement and rock falls; localised high run-on, seasonal waterlogging of low areas; general risks to foundations	30 to 50	Group C/D	0.00	sporadic	ML	0.029	Type F	B
Mallabula Point (mp)	high erosion hazard from steep slopes, some shallow soils, and rock outcrop on uplands; localised high run-on, seasonal waterlogging of low areas;	5 to 30	Group C/D	4.11	sporadic	ML ML CH	0.027 0.036 0.049	Type D Type D Type D	J D I
Myall River (mr)	low-lying areas of permanently high watertables, seasonal	<2	Group C	94.35	endemic	OL	Peaty	Type F	J

Table C14. Port Stephens Soil Landscapes (continued)

Soil landscape	Common constraints	Slope range (%)	Soil hydrologic group	Percent area of high acid sulfate soil risk	Acid sulfate risk	USCS class	K-factor USLE	Sediment type	Sediment basin wall construction (earth)
	waterlogging and flood hazard; some permanently waterlogged areas; general risks to foundations					CL OL CH	>0.069 Peaty 0.010	Type F Type F Type F	C J
North Arm Cove (nc)	generally high erosion hazard; localised areas with high run-on	<15	Group C/D	2.25	sporadic	ML-CL ML-CL CH ML ML	0.036 0.051 0.024 0.043 0.025	Type D Type D Type F Type F Type F	J E A A I
Nungra (ng)	low-lying areas of high run-on, permanently high watertables, seasonal waterlogging and flood hazards; localised risks to foundations	<3	Group C/D	0.98	sporadic	ML ML-CL CL-ML	>0.045 >0.079 >0.093	Type F Type D Type D	J I I
Nerong (no)	generally high erosion hazard; localised shallow soils and rock outcrop; high run-on and seasonal waterlogging of low areas; localised risks to foundations	<15	Group C/D	0.24	sporadic	SM SM CL CH	0.034 0.038 0.027 0.021	Type D Type D Type D Type D	J J E B
Nerong Waterholes (nw)	low areas of high run-on, high watertables, seasonal waterlogging and flood hazard; some permanent waterlogging; general risks to foundations	<2	Group D	10.23	endemic	OH CH CH-MH CH	Peaty 0.025 0.017 0.026	Type D Type D Type D Type D	J B J B
Pindimar Road (pr)	generally high erosion hazard; localised shallow soils and rock outcrop; low areas with high run-on and seasonal waterlogging	<25	Group C	0.05	sporadic	ML ML CH CH CH	0.019 0.047 0.025 >0.090 0.041	Type F Type F Type F Type F Type D	J D C C D
River Road (rr)	generally high erosion hazard; localised steep slopes, shallow soils and rock outcrop; low areas with high run-on and seasonal waterlogging	<40	Group C/D	0.31	sporadic	CL-ML CL-ML CL CH	0.047 >0.032 0.042 0.020	Type D Type F Type D Type D	D I D A
Shoal Bay (sb)	coarse non cohesive soils; high wind erosion hazard; localised areas of permanently high watertables; waterlogging; localised risks to foundations and watertable pollution	<1	Group A	2.48	widespread	SW SW SW SW	0.000 0.000 0.000 0.002	Type C Type C Type C Type C	J I I J
Stockton Beach (sk)	shallow non cohesive soils; wind and wave erosion hazards; localised steep slopes, mass movement; some local high watertables and waterlogging; general risks to foundations	<20	Group A	3.17	widespread	SW SW	0.000 0.000	Type C Type C	I J

Table C14. Port Stephens Soil Landscapes (continued)

Soil landscape	Common constraints	Slope range (%)	Soil hydrologic group	Percent area of high acid sulfate soil risk	Acid sulfate risk	USCS class	K-factor USLE	Sediment type	Sediment basin wall construction (earth)
Shoal Bay Swamp (ss)	low lying area with high run-on, permanently high watertables, permanent waterlogging and flood hazard; non cohesive materials with wind high erosion hazard; general risks to foundations	<5	Group D	7.28	endemic	PT	Peaty	Type F	J
Swamp Trail (sw)	low areas of generally high run-on, seasonal waterlogging and water erosion hazard	<10	Group D	0.00	sporadic	ML ML CL	0.003 0.044 0.036	Type D Type D Type D	J E D
The Branch (tb)	general erosion hazard, high watertables; localised high run-on and seasonal waterlogging in low areas; localised risks to foundations	<4	Group C/D	1.57	sporadic	ML-CL CH CL-ML CL	0.028 0.041 0.069 0.017	Type F Type D Type D Type D	J F D D
Tea Gardens (tn)	permanently high watertable, seasonal waterlogging; localised non cohesive soils and wind erosion; permanent waterlogging in low areas; risks to foundations and waterlogging pollution	<5	Group A	0.99	endemic	SM SM SW-SP SW	Peaty 0.000 0.000 Pan	Type C Type C Type C Type C	J J J
Terreel Ridge (tr)	generally high erosion hazard associated with steep slopes and shallow soils; localised rock outcrop and rock fall hazard; localised high run-on to low areas; general risks to foundations	>20	Group D	0.00	none	ML ML	0.009 0.032	Type F Type F	J A
Tambooy (ty)	low lying, non cohesive sands; generally high watertable, waterlogging and flood hazard; general risks to foundations	<2	Group C/D	93.36	endemic	SM MH SM SM SM	Peaty Peaty 0.000 0.003 Pan	Type F Type F Type C Type F Type F	J J J J J

Table C15. Wallerawang Soil Landscapes

Table 15 Wallerawang Soil Landscapes													
Soil landscape	Common constraints	Slope range (%)	Soil hydrologic group	Acid sulfate risk	USCS Class	K-factor USLE (t.ha.h/ha.MJ.mm)	Sediment type	Sediment basin wall construction (earth)					
Ben Bullen (bb)	localised steep slopes, shallow soils, rock outcrop	5 to 40	Group B	none	ML	0.045	Type F	J					
					SC	0.019	Type F	I					
					CL	0.028	Type F	A					
					SM	0.020	Type F	J					
					SM	0.029	Type F	I					
Cullen Bullen (cb)	high erosion hazard: high run-on to low areas; localised rock outcrop and rock fall; localised risks to foundations	10 to 25	Group C	none	CL	0.050	Type D	nt					
					CL	0.023	Type F	A					
					ML	0.043	Type D	J					
					CH	0.014	Type D	B					
					CL	0.042	Type D	nt					
					ML	0.076	Type F	D					
					CL	0.018	Type F	C					
					SC	0.038	Type D	nt					
					Canobla Gap (cg)	generally high water erosion hazards; localised steep slopes; widespread risks to foundations	20 to 50	Group D	none	SC	0.025	Type F	J
										CL	0.024	Type D	D
CL	0.022	Type D	B										
SW	0.057	Type F	J										
CL	0.040	Type D	J										
Coco (co)	generally steep slopes and shallow soils; localised rock outcrops; some mass movement;	>25	Group B	none	CH	0.008	Type F	C					
					CL	0.015	Type D	A					
					SC	0.054	Type F	D					
					CL-ML	0.045	Type F	J					
					SC	0.039	Type F	B					
					ML	0.047	Type F	J					
					SC	0.049	Type D	D					
					SC	0.029	Type F	B					
					CL	0.035	Type D	D					
					SM	0.031	Type F	J					
					SM	0.035	Type F	J					
					SM	0.030	Type F	J					
					SC	0.049	Type D	nt					
					Deanes Creek (dc)	high run-on, high watertables, waterlogging in low areas; high risks to foundations	<5	Group D	none	SC	0.040	Type F	B
										SC	0.032	Type F	C
SC	0.033	Type F	C										
SP	0.017	Type C	J										
Glen Alice (ga)	generally high water erosion hazards; localised steep slopes;	5 to 20	Group C	none	CL	0.027	Type D	B					

Table C15. Wallerawang Soil Landscapes (continued)

Soil landscape	Common constraints	Slope range (%)	Soil hydrologic group	Acid sulfate risk	USCS Class	K-factor USLE (t.ha.h/ha.MJ.mm)	Sediment type	Sediment basin wall construction (earth)
	local flooding hazards				ML	0.057	Type F	J
					ML	0.059	Type D	B
Gyreea (gy)	shallow soils, widespread water erosion hazard; localised steep slopes and rock fall hazard; high run-on in low areas; low fertility	10 to 25	Group C/D	none	SC	0.018	Type D	nt
Hassans Walls (hw)	very steep slopes, mass movement and rock falls; shallow soils and rock outcrop; high erosion hazard; general risks to foundations	>40	Group D Group C	none	CL SP SP SM	0.019 0.010 0.012 0.052	Type D Type C Type C Type D	B J nt nt
Mount Irvine (ir)	no obvious constraints	<5	Group B	none	ML CL	Peaty 0.033	Type F Type F	J C
Lithgow (li)	very steep slopes, mass movement and rock falls; shallow soils and rock outcrop; high erosion hazard; general risks to foundations	<10	Group B	none	SC ML SM CL	0.026 0.057 0.059 0.030	Type F Type F Type D Type D	J J J A
Long Swamp (ls)	low lying area subject to high run-on, high watertable and waterlogging conditions	<3	Group D	none	SC ML CL	0.029 0.019 0.039	Type D Type D Type D	D J D
Medlow Bath (mb)	localised shallow soils and rock outcrop contribute to areas of high erosion hazard	5 to 15		none	SC SC SW	0.024 0.018 Peaty	Type D Type F Type F	B J J
Marrangaroo (mr)	steep slopes and rock outcrop; permanently high watertables in low areas	<30	Group B Group C Group D	none	SM SC SM SC SM SM CL SM GM SW SW	0.028 0.015 0.029 0.021 0.024 0.021 0.024 0.023 0.022 0.028 0.035	Type F Type F Type F Type F Type F Type F Type D Type F Type F Type F Type C	J C J B J J B J J J J
Mount Sinai (ms)	shallow, non cohesive soils with rock outcrop; steep slopes and widespread rock fall hazard; general risks of wind and	>30		none	SP SC	0.009 0.012	Type C Type F	J J

Table C15. Wallerawang Soil Landscapes (continued)

Soil landscape	Common constraints	Slope range (%)	Soil hydrologic group	Acid sulfate risk	USCS Class	K-factor USLE (t.ha.h/ha.M.J. mm)	Sediment type	Sediment basin wall construction (earth)
	water erosion; general risks to foundations		Group D		SC	0.017	Type F	J
					SC	0.024	Type F	B
			Group D		SC	0.025	Type F	J
					SP	0.009	Type C	J
					SM	0.012	Type F	J
					SC	0.016	Type F	J
					SC	0.012	Type C	I
Mount Walker (mw)	steep slopes with high risks of mass movement and water erosion; localised shallow soils and rock outcrop; localised risks to foundations	>25	Group D	none	ML	0.037	Type D	J
					ML	0.050	Type D	nt
					CL	0.037	Type D	D
					ML	0.032	Type F	J
					CL	0.053	Type F	D
			Group B		ML	0.059	Type F	J
					CL	0.039	Type F	B
					SC	0.068	Type F	I
					SC-CL	0.042	Type D	D
					ML	0.041	Type D	J
Newnes Plateau (np)	localised shallow soils; localised wind erosion	<10	Group B	none	SC	0.025	Type F	J
					SC	0.013	Type F	B
			Group D		SC	0.018	Type F	J
Pipers Flat (pf)	low lying areas subject to high run-on ; localised high watertable and seasonal waterlogging; general risks to foundations	<5	Group C	none	ML	0.054	Type F	B
					SC	0.040	Type F	B
					SC	0.028	Type F	J
					CL	0.055	Type D	D
Port Macquarie (pm)	generally high water erosion hazards; localised non cohesive soils	<25	Group C/D	none	ML	0.036	Type F	J
					ML	0.060	Type D	nt
					CL	0.031	Type F	A
					CL	0.035	Type D	A
Rowans Hole (ro)	generally high water erosion hazards; local flooding hazards	5	Group C/D	none	SC	0.033	Type F	B
					ML	0.053	Type F	J
					CL-ML	0.066	Type F	D
					CH	0.035	Type D	B
Rydal (ry)	shallow soils	10 to25	Group D	none	CL-ML	0.049	Type D	nt
					ML	0.029	Type F	J
					CL	0.046	Type D	D

Table C15. Wallerawang Soil Landscapes (continued)

Table 15 Wallerawang Soil Landscapes									
Soil landscape	Common constraints	Slope range (%)	Soil hydrologic group	Acid sulfate risk	USCS Class	K-factor USLE (t.ha.h/ha.MJ.mm)	Sediment type	Sediment basin wall construction (earth)	
Mount Tomah (to)	localised shallow soils and rock outcrop; localised steep slopes with mass movement hazard	10 to 30	Group D	none	CL	0.047	Type D	D	
					ML	0.017	Type F	J	
					OL-PT	Peaty	Type D	J	
					ML	0.043	Type F	A	
					ML	0.025	Type F	J	
					ML	0.022	Type F	J	
					CL	0.060	Type F	C	
					SC	0.015	Type F	B	
					ML	0.025	Type F	J	
					ML	Peaty	Type F	J	
					CL	0.030	Type F	C	
					CL	0.028	Type F	C	
					ML	Peaty	Type F	J	
CL	0.023	Type D	B						
CL	0.068	Type F	C						
Umbiella (um)	widespread flooding hazard; localised waterlogging and areas of high erosion hazard	<5	Group B/C	none	SC	0.033	Type D	D	
					SM	0.032	Type D	J	
					ML	0.047	Type F	B	
					ML	0.044	Type F	B	
					SP	0.006	Type C	J	
					CL	0.036	Type D	D	
					ML	0.029	Type F	J	
					CL	0.044	Type D	B	
					SP	0.016	Type F	J	
					Warragamba (wb)	very high mass movement and soil erosion hazards; steep slopes, highly permeable soils with low fertility	>35	Group D	none
Wollangambe (wo)	shallow soils with rock outcrop; high erosion hazard; localised steep slopes with mass movement and rock fall hazards; general risks to foundations	<35	Group D	none	SC	0.035	Type F	C	
					SP	0.017	Type F	J	
					ML	0.059	Type D	E	
					SC	0.015	Type F	J	
					SC	0.013	Type F	I	
Wolgan River (wr)	shallow soils upslope; generally high run-on to low areas; localised flooding	<10	Group B Group B/C	none	SC	0.026	Type F	J	
					SC	0.010	Type F	J	
					SM	>0.054	Type F	I	

Table C16. St Albans Soil Landscapes

Table 16 St Albans Soil Landscapes							
Soil landscape	Soil hydrologic group	Percent area of high acid sulfate soil risk	Acid sulfate risk	USCS class	K-factor USLE (t.ha.h/ha.M J.mm)	Sediment type	Sediment basin wall construction (earth)
Colo Heights (ch)	Group C/D	0.00	none	CL	0.037	Type D	J
				CL	0.032	Type D	D
				CL	0.039	Type D	B
				SC-CL	0.036	Type D	B
Greens Creek (gc)	Group B/C	0.00	none	SM	0.036	Type F	J
				CH	0.026	Type D	H
				SM	0.016	Type F	J
	Group B/C			ML	0.031	Type F	J
				CL	0.028	Type F	A
	Group C/D			SM	Peaty	Type F	J
OL		0.032	Type D	J			
Gynea (gy)	Group C/D	0.00	none	SC	0.030	Type F	J
				SM	0.006	Type F	I
				SM	0.030	Type F	J
				SC	0.022	Type D	D
				CL	0.037	Type D	D
				CL	0.047	Type D	D
Hawkesbury (ha)	Group D	0.00	none	SP	0.031	Type F	J
				SP	0.038	Type F	J
				CL	0.033	Type D	B
				SC	0.042	Type D	D
Laguna (lg)	Group C/D	2.59	sporadic	SP	0.041	Type F	J
				SP	0.044	Type F	J
				CL	0.039	Type D	B
	Group D			SM	0.021	Type F	J
				CL	>0.087	Type F	C
MH	0.046	Type D	E				
Lucas Heights (lh)	Group C/D	0.00	none	SM-ML	0.052	Type F	J
				ML	0.058	Type F	B
				CH	0.020	Type F	A
Oxford Falls (of)	Group C	0.00	none	SM	0.012	Type C	J
				SM	0.012	Type C	J
				SM	0.018	Type C	I
				SM	0.014	Type C	J
				CL	0.094	Type F	C
				SM	0.006	Type C	J
				SM	0.021	Type F	J
Putty Creek (pc)	Group C	0.00	none	ML	0.036	Type F	J
				SM	0.015	Type F	J
				OL	0.025	Type F	J
Warragamba (wb)	Group D	0.00	none	SP	0.022	Type C	J
				SP	0.032	Type F	J
				CL	0.035	Type D	B
Wisemans Ferry (wf)	Group C	31.46	common	OL	0.034	Type D	J
				SP	0.028	Type F	J
				ML	0.058	Type D	B
				SP	0.043	Type F	J
				SM-ML	0.050	Type F	I
				ML	0.047	Type D	I
				CL	0.028	Type D	D
OL	0.031	Type D	J				

Table C16. St Albans Soil Landscapes (continued)

Table 16 St Albans Soil Landscapes							
Soil landscape	Soil hydrologic group	Percent area of high acid sulfate soil risk	Acid sulfate risk	USCS class	K-factor USLE (t.ha.h/ha.M J.mm)	Sediment type	Sediment basin wall construction (earth)
Watagan (wn)	Group D	0.14	sporadic	SC	0.067	Type F	C
				SP	0.036	Type F	J
				SC	0.023	Type F	B
				ML	0.048	Type F	J
Wollangambe (wo)	Group C/D	0.00	none	SP	0.012	Type C	J
				CL	0.031	Type F	A
				SC	0.021	Type F	I
				OL	0.040	Type D	J

Table C17. Gosford-Lake Macquarie Soil Landscapes

Soil landscape	Common constraints	Slope range (%)	Soil hydrologic group	Acid sulfate risk	USCS class	K-factor USLE	Sediment type	Sediment basin wall construction (earth)
Awaba (aw)	very high erosion hazard; steep slopes; mass movement hazard; shallow soils with low fertility	10 to 60	Group B/C	sporadic	CH	0.011	Type D	A
Bar Lookout (bl)	mass movement hazard; localised steep slopes	<70	Group D	na	CL	ft	Type F	B
Belmont Swamp (bs)	flooding; permanently high watertable, low fertility	<2	inapplicable	na	SM-SC SM	0.012	Type C Type C	B & I
Doyatson (do)	high erosion and localised run-on hazards; min subsidence and low fertility	<10	Group C/D	na	SM-SC SC CH	0.041 0.029 0.018	Type C Type C Type D	B B B
Erina (er)	very high soil erosion and water run-on hazards; impermeable, plastic subsoils with low wet strength, seasonal waterlogging on footslopes	<2	Group C/D	na	CL SC CL	0.030 0.028 0.006	Type D Type D Type C	D B B
Gorokan (gk)	very high soil erosion hazard; seasonal waterlogging; impermeable soils with low fertility	<15	Group C	na	ML-CL CL	0.050 0.041	Type D Type D	E D
Gymea (gy)	shallow highly permeable soils with very low fertility; rock outcrop; localised steep slopes with high erosion hazard	10 to 25	Group C/D	none	SP SP CL	0.025 0.035 0.027	Type F Type F Type D	J J A
Hawkesbury (ha)	high soil erosion and mass movement hazard; steep slopes rock outcrop; shallow stony, highly permeable soils with low fertility	>25	Group C/D	none	SW SC SC	0.023 0.016 0.032	Type C Type D Type D	J D B
Hawkesbury River (hr)	flood hazard; localised potential for acid sulfate layers; localised permanent and seasonal waterlogging; low fertility	<5	Group D	widespread	SP SP	0.017 0.024	Type F Type F	I J
Laguna (lg)	high erosion hazard; localised mass movement and run-on hazard; low fertility	5 to 25	Group B/C	none	CL SP SW CL	0.013 0.034 0.035 0.011	Type D Type F Type F Type F	A J J C
Lambert (la)	very high soil erosion hazard; rock outcrop, seasonally	<20	Group D	na	SW	0.023	Type C	J

Table C17. Gosford-Lake Macquarie Soil Landscapes (continued)

Table 17 Gosford-Lake Macquarie Soil Landscapes									
Soil landscape	Common constraints	Slope range (%)	Soil hydrologic group	Acid sulfate risk	USCS class	K-factor USLE	Sediment type	Sediment basin wall construction (earth)	
Maroota (ma)	perched watertable; highly permeable soils with very low fertility high soil erosion hazard; localised seasonal waterlogging	<10	Group A	none	SW CL SC	0.036 0.037 0.027	Type C Type F Type C	J B B	
Mangrove Creek (mc)	regular tidal flooding; high acid sulfate potential, saline highly organic layers with low fertility	<3	inapplicable	endemic	SP CL ML SP ML	0.006 0.026 Peaty 0.009 0.015	Type C Type F Type F Type C Type F	J C K J A	
Mandalong (ml)	mass movement hazard; steep slopes; soils with low fertility and low wet strength	20 to 60	Group C/D	na	MH CL-MH	0.062 0.052	Type D Type D	D E	
Narrabeen (na)	high wind and wave erosion hazards; non cohesive, highly permeable soils with low fertility	<45	Group A	na	SP SP-SM	0.007 0.006	Type C Type C	I I	
Norath Head (nr)	extreme wind erosion and high water erosion hazards; non cohesive highly permeable soils with very low fertility	<15	Group A	na	SP-SM SP-SM SM	0.016 0.015 0.021	Type C Type C Type C	J J J	
Oxford Falls (of)	very high erosion hazard, perched watertables; highly permeable soils with very low fertility; localised rock outcrop	<15	Group C/D	none	SP SP SP SP SP SP	0.018 0.017 0.020 0.011 0.015 0.016	Type C Type C Type C Type C Type C Type C	J J J J J J	
Somersby (so)	highly permeable soils with low fertility, localised high watertables and stony areas	<15	Group B	na	SC SC SC SC	0.017 0.046 0.041 0.029	Type C Type C Type C Type C	C D D B	
Sydney Town (st)	very high erosion hazard; localised permanent waterlogging; highly permeable soils with low fertility	5 to 25	Group D	none	CL SP	0.023 0.019	Type D Type C	B J	

Table C17. Gosford-Lake Macquarie Soil Landscapes (continued)

Table 17 Gosford-Lake Macquarie Soil Landscapes									
Soil landscape	Common constraints	Slope range (%)	Soil hydrologic group	Acid sulfate risk	USCS class	K-factor USLE	Sediment type	Sediment basin wall construction (earth)	
Tuggerah (tg)	high wind erosion hazard; highly permeable soils with very low fertility; localised flooding and high water table hazards	1 to 10	Group B	na	SP	0.020	Type D	J	
Tacoma Swamp (ts)	flooding, seasonal waterlogging; localised acid sulfate potential; low fertility	<3	inapplicable	na	SC-OL SC	0.021 0.030	Type C Type D	not applicable	
Warners Bay (wa)	localised steep slopes and mass movement potential; mine subsidence area; seasonal waterlogging on lower slopes; low fertility	<25	Group C/D	sporadic	CH ML ML	0.015 0.019 0.025	Type D Type D Type F	F A A	
Wollombi Brook (wt)	flooding and streambank erosion hazards; localised seasonal waterlogging; non cohesive soils with high permeability and low fertility	<5	Group B	sporadic	SP SP	0.024 0.033	Type F Type F	I J	
Watagan (wn)	high mass movement and soil erosion hazards; steep slopes; localised rock outcrop	>25	Group C/D	sporadic	SW SW SC CL CL CL	0.024 0.036 0.034 0.022 0.024 0.019	Type C Type C Type C Type F Type F Type F	J J B A A A	
Woodburys Bridge (wo)	extreme erosion hazard; localised seasonal waterlogging; low fertility soils with layers of low wet strength	<20	Group C/D	na	ML CH SM-SC	0.050 0.022 0.046	Type D Type D Type D	B F J	
Woy Woy (ww)	permanently high water tables; localised flooding and soil erosion hazards; very low fertility	<5	Group A	na	SP SP	0.007 0.006	Type C Type C	I I	
Wyong (wy)	flooding, seasonal waterlogging and localised streambank erosion hazards; localised potential for acid sulfate soils; poorly drained impermeable soils with low fertility	<3	Group D	na	SC-CL SC-ML	0.03 0.028	Type C Type F	A - B A - B	
Yarramalong (ya)	high run-on, flooding; permanent waterlogging; localised streambank erosion hazard; foundation hazard	<5	Group D	na	SM-SC CL	0.053 0.048	Type F Type F	J D	

Table C18. Katoomba Soil Landscapes

Soil landscape	Common constraints	Slope range (%)	Soil hydrologic group	Acid sulfate risk	USCS class	K-factor	USLE	Sediment type	Sediment basin wall construction (earth)
Ben Bullen (bb)	localised steep slopes, shallow soils, rock outcrop	5 to 40	Group C	none	CL	0.034		Type F	J
					SC	0.020		Type F	B
					SC	0.030		Type F	J
					SC	0.026		Type F	B
					SM	0.017		Type C	I
Boggy Creek (bc)	rock fall hazard; flood hazard; non cohesive soils; high hazard to foundations	<5	Group C	none	MH	0.058		Type D	D
					CL	0.038		Type D	D
					ML	0.052		Type F	I
Blue Gum (bg)	general erosion hazard; widespread non cohesive soils; localised rock falls; localised flooding in low areas	<5	Group B	none	ML	0.038		Type F	J
					SC-CL	Peaty		Type F	J
Boyd Plateau (bp)	localised shallow soils and rock outcrop	<15	Group B	none	SC	0.020		Type F	J
					SC	0.028		Type F	C
					SC	0.028		Type F	C
Black Range (br)	localised shallow soils and waterlogging; high foundation hazard in some areas	<10	Group C	none	SC	0.027		Type D	D
					ML	0.009		Type F	J
					CL	0.034		Type F	B
Cullen Bullen (cb)	high erosion hazard; high run-on to low areas; localised rock outcrop and rock fall; localised hazards for foundations	10 to 25	Group B/C	none	CL	0.052		Type F	J
					MH	0.057		Type D	I
					CL	0.034		Type D	B
Cedar Valley (cv)	steep slopes, shallow soils; high erosion hazard; high hazards for foundations	15 to 60	Group B	none	SM	0.054		Type F	J
					SM	0.055		Type F	J
					CL	0.025		Type D	B
Coxs River (cx)	high erosion hazard; flood hazard; hazards for foundations	<5	Group C	none	ML	0.061		Type D	J
					SM	0.027		Type F	I
					SP	0.010		Type C	I
Deanes Creek (dc)	high run-on, high waterables, waterlogging in low areas; high hazards for foundations	<5	Group C/D	none	SC	0.025		Type F	J
					SC	0.037		Type D	I
					ML	Peaty		Type F	I
					SC	0.043		Type F	C
Faulconbridge (fb)	shallow soils with localised rock outcrop	<5	Group B	none	SC	0.003		Type F	J
					CL	0.015		Type F	A
					SC	0.029		Type F	I

Table C18. Katoomba Soil Landscapes (continued)

Table 18 Katoomba Soil Landscapes									
Soil landscape	Common constraints	Slope range (%)	Soil hydrologic group	Acid sulfate risk	USCS class	K-factor USLE	Sediment type	Sediment basin wall construction (earth)	
Ganbenang (gb)	high erosion hazard; seasonal waterlogging;	<10	Group D Group C	none	SC	0.041	Type F	I	
						0.035	Type F	A	
						0.042	Type F	I	
						0.038	Type D	B	
Gum Valley (gy)	general water erosion hazard	<25	Group B	none	CL	0.036	Type F	J	
					CL	0.052	Type F	C	
					ML	0.028	Type D	J	
					CL	0.046	Type D	D	
					CL	>0.082	Type F	C	
Gynea (gy)	shallow soils, widespread water erosion hazard; localised steep slopes and rock fall hazard; high run-on in low areas; low fertility	10 to 25	Group C/D	none	ML	0.035	Type F	J	
					CL	0.028	Type D	D	
					CL	0.034	Type D	D	
					SC	0.023	Type D	D	
Hawkesbury (ha)	high soil erosion and mass movement hazard; steep slope, rock outcrop, shallow stony highly permeable soils with low fertility	>25	Group C	none	SM	0.024	Type F	J	
					SC	0.060	Type F	C	
Hassans Walls (hw)	very steep slopes, mass movement and rock falls; shallow soils and rock outcrop; high erosion hazard; general hazard for foundations	>40	Group C	none	CL	0.025	Type F	J	
					CL	0.042	Type D	D	
					CL	0.044	Type D	D	
					SM	Peaty	Type F	J	
Mount Irvine (ir)	no obvious constraints	<5	Group D	none	ML	Peaty	Type F	J	
					CL	0.050	Type F	C	
Jenolan Caves (jc)	steep slopes, shallow soils, rock outcrop and rock fall hazard; high erosion hazard	>50	Group B	none	CL	0.008	Type F	J	
					CL	0.007	Type F	G	
Kanangra Gorge (ka)	shallow soils and steep slopes; mass movement and rock fall hazards; high erosion hazard; localised hazards for foundations	>30	Group C	none	GC	0.045	Type C	D	
					SM	Peaty	Type F	J	
					SM	0.042	Type F	J	
					SC	0.077	Type F	C	
Kedumba (ke)	water erosion hazard	5 to 15		none	SC	0.046	Type F	D	
					CL	0.027	Type D	B	
					ML	0.037	Type F	J	

Table C18. Katoomba Soil Landscapes (continued)

Soil landscape	Common constraints	Slope range (%)	Soil hydrologic group	Acid sulfate risk	USCS class	K-factor	USLE	Sediment type	Sediment basin wall construction (earth)
Kurrajong (kg)	shallow soils; high erosion hazard; localised waterlogging and mass movement	>10	Group C	none	MH CL CL	Peaty 0.026 0.029		Type F Type D Type D	J A A
Kanangra Tops (kt)	shallow, non cohesive soils with rock outcrops; high wind and water erosion hazard	<10	Group A	none	SP SM CL	0.012 0.016 0.028		Type C Type F Type D	J J B
Lithgow (ll)	high run-on to low areas; subject to localised rock fall and mine subsidence	<10	Group C	none	SC SM-SC CL ML	0.040 0.047 0.024 0.036		Type F Type F Type F Type F	J I A J
Long Swamp (ls)	low lying area subject to high run-on, high watertable and waterlogging conditions	<3	Group C	none	ML CL CL	0.021 0.019 0.046		Type D Type D Type D	J A D
Medlow Bath (mb)	localised shallow soils and rock outcrop contribute to areas of high erosion hazard	5 to 15	Group B	none	SC SC SC SW	0.022 0.025 0.032 0.035		Type F Type F Type F Type F	J I J J
Morong Swamps (mo)	low lying area subject to high run-on, high watertable and waterlogging	<3	Group C/D	none	ML SC	0.020 0.027		Type F Type F	C C
Marrangaroo (mr)	steep slopes and rock outcrop; permanently high watertables in low areas	<30	Group C	none	CL SM SC SC	0.026 0.030 0.031 0.024		Type D Type F Type F Type D	B J I B
Mount Sinai (ms)	shallow, non cohesive soils with rock outcrop; steep slopes and widespread rock fall hazard; general risk of wind and water erosion; general hazard for foundations	>30	Group B	none	SC SC SC SC	0.027 0.022 0.019 0.036		Type F Type F Type F Type F	J J I I
Mount Walker (mw)	steep slopes with high non cohesive mass movement and water erosion; localised shallow soils and rock outcrop; localised hazards for foundations	>25	Group B	none	CL ML ML CL	0.039 0.032 0.052 0.034		Type F Type F Type D Type F	B J B B
Pipers Flat (pf)	low lying areas subject to high run-on ; localised high	<5	Group C	none	MH	>0.065		Type D	J

Table C18. Katoomba Soil Landscapes (continued)

Soil landscape	Common constraints	Slope range (%)	Soil hydrologic group	Acid sulfate risk	USCS class	K-factor USLE	Sediment type	Sediment basin wall construction (earth)
	water table and seasonal waterlogging; general hazard for foundations				CL SC	0.057 0.057	Type D Type D	D D
Round Mount (rm)	steep slopes with shallow soils and rock outcrop; general hazard for foundations	>35	Group A	none	SC SC SM-SC	0.019 0.039 0.023	Type F Type F Type F	J I I
Mount Tomah (to)	localised shallow soils and rock outcrop; localised steep slopes with mass movement hazard	10 to 30	Group B	none	CL CL CL SC SC	0.041 Peaty 0.084 Peaty 0.025	Type F Type F Type F Type F Type F	C J C J I
Thurat Tops (tt)	shallow soils and rock outcrop; localised areas of high erosion hazard	<15	Group D	none	ML MH	0.011 0.020	Type F Type F	I I
Warragamba (wb)	very high mass movement and soil erosion hazards; steep slopes; highly permeable soils with low fertility	>35	Group C	none	ML MH SC	0.046 0.058 0.026	Type D Type F Type F	B A J
Wollangambe (wo)	shallow soils with localised rock outcrop; high erosion hazard; localised steep slopes with mass movement and rock fall hazards; general hazard to foundations.	<35	Group B	none	SC SC SC MH	0.015 0.029 0.049 0.054	Type F Type F Type F Type D	J I I B

Table 19 Penrith Soil Landscapes

Soil landscape	Common constraints	Slope range	Soil hydrologic group	Acid sulfate risk	USCS class	K- factor	Sediment type	Sediment basin wall construction (earth)
Agnes Banks (ab)	high wind and soil erosion hazards; non cohesive soils with low fertility, high permeability and seasonally high watertables	0-5	Group A	no A-S data available for this sheet	na	na	Type C	I
Bakers Lagoon (ba) (bl)	high watertables plastic soils	0-5	not applicable		OL CL	0.051 0.043	Type D Type D	J D
Berkshire Park (bp) (bp)	impermeable waterlogged subsoils, low fertility	0-5	Group C		CL	0.048	Type F	A
Blacktown (bt)	soils poorly drained with low fertility, localised high plasticity and expansive subsoils	0-5	Group C		ML/CL CL CL	na 0.038 na	Type F Type D Type D	B G G
Burralow Swamp (bs)	high flooding hazard, seasonally high watertable, soils with high permeability and low fertility	0-10	Group B		SP SC	0.023 0.011	Type C Type C	J J
Faulconbridge (fb) (fb)	shallow, highly permeable soils with low fertility; rock outcrop	0-5	Group D		SM CL	ft 0.035	Type C Type D	J A
Freemans Reach (fr) (fr)	high flooding and streambank erosion hazards; soils with high permeability and low fertility	0-5	Group B/C		ML CL-ML CL	0.046 0.038 0.025	Type F Type F Type D	A B A
Gynea (gy)	shallow highly permeable soils with very low fertility; rock outcrop; localised steep slopes with high soil erosion hazard	10-25	Group C/D		SM SC CL	0.022 0.034 0.032	Type C Type F Type D	B&I C A
Hawkesbury (ha)	high soil erosion and mass movement hazard; steep slope, rock outcrop, shallow stony highly permeable soils with low fertility	>25	Group D		SC SC	na 0.033	Type C Type F	C C
Hazelwood (hw)	high mass movement and sheet erosion hazards; soil with high permeability, high erodibility and low fertility	>60	Group B		SM CL	0.035 0.034	Type C Type F	J A
Kurrajong (kg)	localised mass movement hazard; localised waterlogging; localised steep slopes; some soils shallow and expansive	>10	Group C		CL	0.033	Type D	B
Lucas Heights (lh)	stony soil, low soil fertility, low available water capacity	0-10	Group C/D		SM	0.053	Type C	B&I

Table C19. Penrith Soil Landscapes (continued)

Table 19 Penrith Soil Landscapes									
Soil landscape	Common constraints	Slope range	Soil hydrologic group	Acid sulfate risk	USCS class	K- factor	Sediment type	Sediment basin wall construction (earth)	
					SC CL	0.042 0.024	Type D Type F	B A	
Luddenham (lu)	moderately expansive, low wet strength, localised impermeable and highly plastic subsoils	5-20	Group C		CL CL CL	0.038 na na	Type D Type F Type D	B A A	
Picton (pn)	high mass movement hazard; low permeability; low fertility; localised high expansion	>20	Group C		CL CL	na 0.034	Type D Type D	D B	
Richmond (ri)	high soil erosion hazard (particularly at terrace edges) and localised flooding hazards; localised salinity	0-1	Group C		CL	0.059	Type F	A	
South Creek (sc)	high flooding hazard; localised permanently high watertables; low fertility; localised salinity	0-5	Group C/D		CL	0.05	Type F	A	
Upper Castlereagh (up)	very high soil erosion hazard; dispersible, impermeable soil layers	0-5	Group C/D		SC CL	na 0.032	Type D Type F	D D	
Volcanic (vo)	moderately expansive soils with low wet strength, high soil erosion and mass movement hazards on steep slopes	5-60	Group C/D		CL	0.029	Type F	B	
Warragamba (wb)	very high mass movement and soil erosion hazards; steep slopes, highly permeable soils with low fertility	>35	Group C		SM SC	0.036 0.032	Type C Type D	J B	
Woodlands (wl)	soils with low fertility and low water holding capacity	0-10	Group B/D		CL CL	0.029 na	Type F Type F	C B	

Table C20. Sydney Soil Landscapes

Soil landscape	Common constraints	Slope range	Soil hydrologic group	Acid sulfate risk	USCS class	K- factor	Sediment type	Sediment basin wall construction (earth)
Birrong (bi)	localised high flooding and erosion hazard; saline subsoils, seasonal waterlogging, very low soil fertility	0-3	Group C	no A-S data available for this sheet	CL CL-CH SC	0.047 0.015 0.031	Type D Type D Type D	D D D
Blacktown (bt)	soils poorly drained with low fertility, localised subsoil, moderately expansive, highly plastic	0-5	Group C		CL CL CL-CH	0.038 na na	Type D Type D Type D	B D B
Cockle Bay (cb)	very high soil erosion and high water run-on hazards; high watertable, seasonally waterlogged soils with low fertility	0-5	Group B		SM CL CL	0.036	Type C Type D Type D	J D D
Deep Creek (dc)	high flooding, soil erosion and sedimentation hazards; permanently high watertables and localised very low fertility	0-3	Group B/C		SP	0.002	Type C	I
Erina (er)	very high soil erosion and localised high water run-on hazards; impermeable, plastic clays with low wet strength, seasonal waterlogging on the footslopes	0-20	Group C/D		ML CL CL CL	na 0.028 0.042 na	Type C Type D Type D Type D	A B B A
Ettalong (et)	high flooding hazard; permanently high watertable; extremely acid organic layers with low fertility	0-2	not applicable		PT SM	na 0.019	Type C	J I
Faulconbridge (fb)	shallow, highly permeable soils with low fertility; rock outcrops	0-5	Group D		SM SM	ft 0.053	Type C Type C	J B&I
Glenorie (gn)	high soil erosion hazard; localised impermeable highly plastic subsoils, moderately expansive	5-20	Group C		ML-CL CL CL	0.025 0.04 na	Type F Type D Type D	C C D
Gymea (gy)	shallow highly permeable soils with very low fertility; rock outcrop; localised steep slopes with high soil erosion hazard	10-25	Group C/D		SM SC ML-CL	0.018 0.025 0.046	Type C Type F Type D	B&I C B
Hawkesbury (ha)	high soil erosion and high mass movement hazard; steep slope, rock outcrop; shallow, stony, highly permeable soils with low fertility	>25	Group D		SM SM SM	0.024 0.027 0.025	Type C Type D Type F	B&I B&I B&I

Table C20. Sydney Soil Landscapes (continued)

Soil landscape	Common constraints	Slope range	Soil hydrologic group	Acid sulfate risk	USCS class	K- factor	Sediment type	Sediment basin wall construction (earth)
Hornsby (ho)	highly plastic low wet strength, highly expansive subsoil; steep slope; localised mass movement hazard	3-65	Group C/D		CH SC CL-CH	0.013 0.023 0.017	Type D Type C Type D	A C B&D
Lambert (la)	very high soil erosion hazard; rock outcrop, seasonally perched watertable; highly permeable soils with very low soil fertility	0-20	Group D		SC SM CL	0.027 0.018 0.037	Type C Type C Type D	C J B
Lane Cove (lc)	high flooding and soil erosion hazards; seasonal waterlogging	0-5	Group B		SC	0.019	Type C	B
Lucas Heights (lh)	stony soils, low fertility, low available water capacity	0-10	Group C/D		SM SC CL	na 0.042 0.024	Type C Type D Type F	B&I B B
Mangrove Creek (mc)	regular tidal flooding; high acid sulfate potential, saline highly organic soils with low fertility	0-3	not applicable		SP-SM SC CL SP	0.01 0.034 0.024 0.007	Type C Type D Type F Type C	I D C J
Narrabeen (na)	high wind and wave erosion hazards; non cohesive, highly permeable soils with low fertility	0-45	Group A		SP SP-SC	0.007 0.006	Type C Type C	I na
Newport (np)	very high erosion hazard; localised steep slopes; non cohesive topsoils with low fertility	0-35	Group B		SM	0.042	Type C	J
North Head (nh)	high wind and water erosion hazards; non cohesive, highly permeable soils with very low fertility	0-15	Group A		SC SP-SM SP	0.013 0.011 0.009	Type C Type C Type C	B J I
Oxford Falls (of)	very high erosion hazards, perched watertables; highly permeable soils with very low fertility; localised rock outcrop	0-15	Group C/D		SM SM SP-SM	0.023 0.021 0.018	Type C Type C Type C	I C&I I
Somersby (so)	highly permeable soils with low fertility, localised high watertables; localised stony topsoils	0-15	Group B		SM CL-CH ^{AC}	0.027 ft 0.046	Type C Type D Type D	I C B
Tuggerah (tg)	high wind erosion hazard; non cohesive highly permeable soils with very low fertility, localised flooding hazard and	1-10	Group B		SM SP-SM	0.009 0.016	Type C Type C	I J

Table C20. Sydney Soil Landscapes (continued)

Soil landscape	Common constraints	Slope range	Soil hydrologic group	Acid sulfate risk	USCS class	K- factor	Sediment type	Sediment basin wall construction (earth)
	permanently high watertable				SP	0.006	Type C	I
Warriewood (wa)	localised high run-on and flooding hazards; high watertables; highly permeable soils	0-3	Group A		SP	0.018	Type C	I
Watagan (wn)	high mass movement and soil erosion hazards; steep slopes; occasional rock outcrop	>25	Group C/D		SM	0.043	Type C	J
					SC	0.034	Type C	B
					CL-CH	0.027	Type D	B
					CH	0.021	Type D	D
West Pennant Hills (wp)	high mass movement and soil erosion hazards; steep slopes; localised seasonal waterlogging, highly impermeable plastic layers with high volume expansion potential	>20	Group C/D		CL	0.026	Type F	A
					CL-CH	0.022	Type D	B
Woy Woy (ww)	permanently high watertables; localised flooding soil erosion hazards; low to very low fertility	0-5	Group C		SP	0.005	Type C	I
					SP	na	Type C	I

Table C21. Wollongong-Port Hacking Soil Landscapes

Soil Landscape	Common constraints	Slope range	Soil hydrologic group	Acid sulfate risk	USCS class	K- factor	Sediment type	Sediment basin wall construction (earth)
Berkeley (bk)	mass movement hazard, extreme erosion hazard, expansive soils, locally impeded drainage	10-50	Group C	no A-S data available for this sheet	CL	0.022	Type D	D
Blacktown (bt)	soils poorly drained with low fertility, localised plastic subsoils with moderate volume expansion	0-5	Group C		CL CL	0.038 na	Type F Type D	A G
Bundeena (bu)	high erosion hazard, highly permeable soil, very low fertility, localised seasonally high watertable	0-20	Group D		SW	0.018	Type C	J
Fairy Meadow (fm)	high flooding hazard; highly permeable soils, seasonally high watertables, low wet bearing strength and low fertility	0-5	Group B		SP-SM CL CH ML	0.025 0.024 0.024	Type C Type F Type F Type F	I C C na
Faulconbridge (fb)	shallow highly permeable soils with low fertility; rock outcrop	0-5	Group D		CL SM SM-SW	0.035	Type D Type C Type C	na I&J I
Gwynneville (gw)	extreme erosion hazard, steep slopes, mass movement hazard, local flooding; subsoils expansive and impermeable with low wet bearing strength	3-25	Group C/D		ML CL	0.025 0.024	Type F Type D	A A
Gymea (gy)	shallow, highly permeable soils with very low fertility; rock outcrop; localised steep slopes with high erosion hazard	10-25	Group C/D		SM SC CL	0.022 0.034 0.042	Type C Type F Type D	B&I C A
Hawkesbury (ha)	high soil erosion and high mass movement hazard; steep slope, rock outcrop; shallow, stony, highly permeable soils with low fertility	>25	Group D		GM SC SC	0.024 0.033 na	Type C Type D Type F	B&I C C
Illawarra Escarpment (ie)	mass movement and rock fall hazard; steep slopes and extreme erosion hazard; soils are reactive with low wet bearing capacity and low to moderate fertility	20-50	Group D		CL ML	0.033 na	Type D Type C	B B
Kurnell (kn)	extreme wind erosion hazard; highly permeable soils with low fertility and localised permanently high watertables	1-10	Group A		SC	na	Type C	K

Table C21. Wollongong-Port Hacking Soil Landscapes (continued)

Soil Landscape	Common constraints	Slope range	Soil hydrologic group	Acid sulfate risk	USCS class	K-factor	Sediment type	Sediment basin wall construction (earth)
Lucas Heights (lh)	stony soils, low fertility, low available water capacity	0-10	Group C/D		CH CL CL	na 0.024 na	Type D Type F Type F	B C C
Luddenham (lu)	moderately expansive, low wet strength, localised impermeable and highly plastic clays	5-20	Group C/D		CL CL	0.038 na	Type D Type F	A A
Maddens Plains (md)	seasonal and permanent waterlogging, low fertility and high erosion hazard	0-10	Group B		SW SC	0.03 0.035	Type C Type C	I B
Mangrove Creek (mc)	regular tidal flooding; high acid sulfate potential, saline highly organic layers with low fertility	0-3	not relevant		CL SM SP-SM SC	0.024 na 0.016 0.034	Type F Type C Type C Type D	C I I D
Monkey Creek (mk)	flood hazard, low permeability; reactive soils with low fertility	1-2	Group C/D		CL CL	0.027 na	Type F Type F	B B
Picton (pn)	high mass movement hazard; low permeability and low fertility, local highly expansive	>20	Group C/D		CL	0.034	Type D	D
Theresa Park (tp)	localised flooding seasonal waterlogging; very high soil erosion hazard	0-10	Group B/C		variable	0.039	Type F	variable
Warragamba (wb)	very high mass movement and high soil erosion hazards; steep slopes; highly permeable soils and low fertility	>35	Group D		SM SC CL	0.036 0.032	Type C Type D Type F	I B A
Watagan (wn)	high mass movement and high soil erosion hazards; steep slopes; occasional rock outcrop	>25	Group D		SC SM CL	0.034 0.043 0.019	Type C Type C Type F	B I B
Wollongong (wg)	extreme wind erosion hazard; localised flooding and permanently high waterables; non cohesive highly permeable soils with low fertility	3-35	Group A		SP SW	0.042 na	Type C Type C	I I
Yarrawarra (ya)	highly permeable soils with permanently high waterables; shallow soils; low wet strength; high erosion hazard; very low fertility	5-20	Group D		SM SC-CL CL	0.029 0.041 0.022	Type C Type F Type D	J B D

Table C22. Kiama Soil Landscapes

Soil landscape	Common constraints	Slope range	Soil hydrologic group	Acid sulfate risk	USCS class	K- factor	Sediment type	Sediment basin wall construction (earth)
Albion Park (ap)	waterlogging; seasonally high watertable; high expansion	5-15	Group C	no A-S data available for this sheet	CL	0.026 0.035 na	Type D Type C Type D	D J K
Barren Grounds (ba)	waterlogging; permanent high watertable; low fertility	0-10	Group D		SM SC	0.015 0.043	Type C Type F	J B
Barrengarry (bg)	localised mass movement; water erosion; localised run-on hazards	10-13	Group B		CL CL	0.03 na	Type F Type F	C C
Bombo (bo)	rock fall, rock outcrop; wave erosion hazard; low wet strength	15-25	Group B		CL ^{AC}	ft	Type F	A
Cambewarra (ca)	rock fall, mass movement, extreme water erosion hazards; shallow soils; low wet strength	>30	Group C		CL ^{AC}	ft	Type F	C
Coolongatta (co)	water erosion hazard; localised mass movement, surface movement potential; high expansion potential	5-20	Group C		CH ^{AC} CL	0.02 0.038	Type F Type F	C C
Ellerslie (el)	flooding hazard; permanent high watertable; layers with low permeability and low wet strength	0-5	Group C		CL ML SM	0.052 0.06 0.034	Type D Type C Type C	B A B&I
Fairy Meadow (fa)	high flooding hazard; high permeability soils; high seasonal watertables, low wet bearing strength, low fertility	0-5	Group A/B		SC CL ML	na 0.024 0.024	Type C Type F Type F	B A A
Fountaindale (fo)	localised water erosion hazard; run-on; localised mass movement hazard; moderately expansive	0-20	Group C		ML CL	0.026 0.014	Type F Type F	A B
Greenwall Point (gp)	localised shallow soil and rock outcrop; moderately expansive	>3	Group C		ML CL ^{AC}	0.042 0.023	Type F Type F	A C
Hawkesbury (ha)	high soil erosion and high mass movement hazard; steep slopes, rock outcrop; shallow, stony, highly permeable soils with low fertility	>25	Group D		SM CL	0.024 0.033	Type C Type F	B&I A
Illawarra Escarpment Escarpment (es)	mass movement and rock fall hazard; steep slopes and extreme erosion hazard; soils are expansive with low wet strength	20-50	Group D		ML ML	na na	Type C Type C	A C

Table C22. Kiama Soil Landscapes (continued)

Soil landscape	Common constraints	Slope range	Soil hydrologic group	Acid sulfate risk	USCS class	K- factor	Sediment type	Sediment basin wall construction (earth)
	strength and low to moderate fertility				CL	0.033	Type F	C
Jamberoo (ja)	very high surface run-on	0-25	Group B		CL ^{AC}	ft	Type F	C
Kiama (ka)	high run-on and low permeability; localised mass movement hazard; subsoils are sodic with low wet bearing strength and moderate expansion	0-20	Group B/C		ML-CL CL ^{AC}	0.04 0.018	Type F Type F	A C
Killalea (ki)	flood hazard, waterlogging, low permeability and permanently high water table; high expansion potential	0-3	Group C		OL ML	0.023 0.034	Type F Type F	J A
Nowra (no)	low permeability and low wet bearing strength; high run-on; localised shallow soils with localised rock outcrop	>5	Group C		ML CL ^{AC}	0.047 0.02	Type F Type D	A A
Pulpit Rock (pr)	steep slopes, mass movement hazard; shallow soils with rock outcrop and low available water-holding	>30	Group D		SW SM CL	0.015 0.033 0.031	Type C Type C Type D	I J B
Robertson (ro)	localised steep slopes; high permeability; sodic layers	0-20	Group B		CL ML ^{AC}	0.026 0.01	Type F Type F	C C
Seven Mile (sm)	non cohesive soils with wind erosion potential; includes sodic saline layers with low fertility and very low water holding capacity	0-20	Group A		SW SC-CL CL	0.043 0.045 0.039	Type C Type F Type D	J B C
Shellharbour (sh)	localised water erosion hazard, shallow soil and mass movement; subsoils are highly expansive with low permeability and low wet strength; generally sodic	0-20	Group C		CL SC-CL	0.035 0.024	Type D Type D	D D
Shoalhaven (sf)	flood hazard, seasonal waterlogging and permanently high water tables; subsoils have acid sulfate potential and are strongly acid	0-3	Group C	common	ML CL	0.039	Type F Type F	C C
Wattamolla Road (wr)	localised mass movement hazard and high surface water run-on; soils have low wet bearing strength	5-15	Group B/C		CL	ft	Type D	A

Table C22. Kiama Soil Landscapes (continued)

Soil landscape	Common constraints	Slope range	Soil hydrologic group	Acid sulfate risk	USCS class	K- factor	Sediment type	Sediment basin wall construction (earth)
Wildes Meadow (wm)	surface movement potential and localised mass movement hazard; localised seasonal waterlogging; water erosion hazard; soils are strongly acid	10-20	Group C		CL ^{AC}	ft	Type F	C
Wingecarribee (wi)	high run-on and waterlogging; permanently high watertables and low wet bearing strength	0-3	Group C/D		ML CL	0.039 0.026	Type F Type D	A B
Wollongong (wg)	extreme wind erosion hazard; localised flooding and permanently high watertables; non cohesive highly permeable soils with low fertility	3-25	Group A		SP	0.042	Type C	I

Table C23. Wagga Wagga Soil Landscapes (continued)

Table 23 Wagga Wagga Soil Landscapes							
Soil landscape	Soil hydrologic group	Acid sulfate risk	Percent area of low acid sulfate soil risk*	USCS class	K-factor USLE (t.ha.h/ha.MJ.mm)	Sediment type	Sediment basin wall construction (earth)
Belfrayden (be)	Group B	none	0.00	ML	0.054	Type F	B
				CL	0.059	Type F	C
				CL	0.018	Type F	C
	Group C			CL	0.045	Type F	B
				CL	0.058	Type F	B
				CL	0.047	Type F	B
	Group B			SM	0.027	Type F	J
				SM-ML	0.046	Type F	J/B
				CL	0.010	Type F	G
CH		0.013	Type D	G			
Becks Lane (bk)	Group D	none	0.00	ML	0.056	Type F	B
				CL	0.044	Type F	B
				CL	0.025	Type F	A
	Group C			ML	0.059	Type D	J
				ML	0.053	Type D	D
				CL	0.037	Type F	B
	Group C			ML	0.058	Type F	J
				ML	0.064	Type F	B
				CL	0.024	Type F	A
Benloch (bl)	Group B	none	0.00	CL	0.038	Type F	B
				CL	0.026	Type F	C
				CL	0.063	Type F	G
	Group B			ML	0.062	Type F	J
				ML	>0.083	Type D	I
				CH	0.018	Type D	D
				CL	0.037	Type D	D
Bullenbong Road (br)	Group B	none	0.00	ML	0.059	Type F	J
				ML	0.073	Type F	I
				CL	0.065	Type F	B
				CL	0.061	Type F	B
Big Springs (bs)	Group B	none	0.00	SM	0.052	Type F	J
				SM	0.043	Type F	J
				CL	0.039	Type F	A
				SC-CL	0.042	Type F	B/A
Bullenbong Plain (bu)	Group D	none	0.00	OL	0.015	Type D	J
				CL	0.023	Type D	B
				CL	0.020	Type D	B
	Group D			CL	0.045	Type D	D
				CH	0.024	Type D	D
				CH	0.033	Type D	D
Currawarna (cw)	Group A	none	0.00	SP	0.037	Type F	I
				SP	0.027	Type F	J
				SP	0.027	Type F	J
East Bomen (eb)	Group D	none	0.00	CL	0.045	Type F	B
				CL	0.030	Type F	C
				CL	0.033	Type F	C
	Group C/D			SC	0.035	Type F	C
				CL	0.045	Type F	C
				SC-CL	0.045	Type F	B
				SC	0.032	Type F	B
				SC	0.030	Type F	B
	Group C			CL	0.020	Type D	A
				ML	0.050	Type F	A
				CL	0.042	Type F	B

Table C23. Wagga Wagga Soil Landscapes (continued)

Table 23 Wagga Wagga Soil Landscapes							
Soil landscape	Soil hydrologic group	Acid sulfate risk	Percent area of low acid sulfate soil risk*	USCS class	K-factor USLE (t.ha.h/ha.MJ.mm)	Sediment type	Sediment basin wall construction (earth)
Farnham (fa)	Group C	none	0.00	OL	0.023	Type D	J
				CL	0.025	Type D	B
				SM	0.019	Type F	J
Forest Hill (fh)	Group C	none	0.00	ML	0.046	Type F	J
				CL	0.048	Type F	B
				CL	0.024	Type F	C
				CL	0.022	Type F	C
Grubben (gb)	Group C	none	0.00	ML	0.044	Type F	J
				ML	0.064	Type D	E
	Group C/D	ML	0.048	Type F	J		
		ML	0.064	Type F	A		
		CL	0.032	Type D	B		
Glenmornon (gl)	Group C/D	none	0.00	SM	0.046	Type F	I
				SC	0.025	Type F	B
				CL	0.017	Type F	G
	Group B	SC	0.030	Type F	J		
		SM	0.044	Type F	J		
		CL	0.043	Type F	C		
Gregadoo (gr)	Group A/B	none	0.00	ML	0.065	Type F	J
				SM	0.062	Type F	J
	Group B	SC-CL	0.036	Type F	B/A		
		SM	0.038	Type F	J		
		SM	0.040	Type F	J		
		CL	0.040	Type D	D		
Kyeamba Downs (kd)	Group A/B	none	0.00	SM	0.033	Type F	J
				SM	0.040	Type F	J
				CL	0.027	Type F	A
				CL	0.016	Type F	A
	Group B/C	ML	0.043	Type D	J		
		SM-SC	0.048	Type F	J/B		
		CH	0.011	Type F	C		
Kurrajong Plain (kp)	Group C/D	none	0.00	ML	0.045	Type D	B
				MH	0.047	Type D	A
				ML	0.052	Type D	B
				ML	0.054	Type F	A
Lloyd (ld)	Group C	none	0.00	ML	0.041	Type F	J
				ML	0.052	Type D	B
				CL	0.022	Type D	A
				CL	0.037	Type F	B
				ML	0.054	Type D	J
				ML	0.064	Type D	D
				CL	0.030	Type D	B
	Group B/C	SM-ML	0.047	Type F	B&A		
		CL	0.016	Type F	C		
		CH	0.010	Type F	C		
	Group C	SM	0.036	Type F	J		
		SM	0.052	Type D	J		
	Livingstone (li)	Group B/C	none	0.00	ML	0.054	Type F
SM					0.051	Type F	J
CL					0.020	Type F	A
Group B		SM-ML	0.053	Type F	J		
		SM	0.059	Type F	J		

Table C23. Wagga Wagga Soil Landscapes (continued)

Table 23 Wagga Wagga Soil Landscapes							
Soil landscape	Soil hydrologic group	Acid sulfate risk	Percent area of low acid sulfate soil risk*	USCS class	K-factor USLE (t.ha.h/ha.MJ.mm)	Sediment type	Sediment basin wall construction (earth)
				CL	0.050	Type D	D
				OL	0.039	Type F	J
				ML	0.049	Type F	A
Mangoplah (ma)	Group B/C	none	0.00	ML	0.048	Type F	J
				MH	>0.081	Type D	E
				CL	0.024	Type D	G
				CL	0.037	Type D	D
Mount Flakney (mf)	Group C	none	0.00	SM	0.030	Type F	J
				SM	0.032	Type F	J
				SM	0.042	Type F	J
				SC-CL	0.038	Type F	B/A
O'Briens Creek (ob)	Group C/D	none	0.00	ML	0.067	Type D	J
				ML	0.062	Type D	D
				CL	0.022	Type D	A
				ML	0.057	Type D	J
				ML	>0.084	Type D	E
				CL	>0.086	Type F	C
				CL	0.028	Type D	B
	Group B/C			ML	0.062	Type D	J
				ML	0.067	Type D	B
				CL	>0.087	Type F	C
				CL	0.033	Type F	A
Pearson (pe)	Group C/D	none	0.00	CL	0.050	Type F	J
				ML	0.057	Type D	D
				CH	0.011	Type F	C
				CL	0.018	Type D	A
	Group B			CL	0.036	Type F	C
				CH	0.050	Type F	H
				CH	0.051	Type F	C
Pulletop (pu)	Group B/C	none	0.00	ML	0.057	Type F	J
				ML	0.078	Type D	I
				CL	0.026	Type F	A
				CL	0.029	Type D	A
	Group C/D			ML	0.067	Type F	J
				ML	0.072	Type F	B
				CL	0.027	Type F	A
				CL	0.027	Type F	A
	Group B			ML	0.061	Type F	A
				CL	0.064	Type F	C
				CL	0.064	Type F	C
	Group C/D			ML	0.059	Type F	J
				ML	0.062	Type D	I
				CL	0.025	Type F	A
Redbank (rb)	Group B/C	none	0.00	ML	0.057	Type F	J
				ML	0.072	Type F	B
				CL	0.019	Type F	A
				CL	0.017	Type F	G
	Group B/C			ML	0.045	Type F	A
				ML	0.065	Type D	I
				CH	0.024	Type D	F
Rockedge (re)	Group B	none	0.00	ML	0.061	Type F	J
				SP	0.066	Type F	J
				ML	0.065	Type F	J
				ML	0.071	Type F	I

Table C23. Wagga Wagga Soil Landscapes (continued)

Table 23 Wagga Wagge Soil Landscapes							
Soil landscape	Soil hydrologic group	Acid sulfate risk	Percent area of low acid sulfate soil risk*	USCS class	K-factor USLE (t.ha.h/ha.MJ.mm)	Sediment type	Sediment basin wall construction (earth)
				ML	0.048	Type D	D
Rio Grande (ri)	Group B	none	0.00	CL	0.044	Type F	I
				SC	0.049	Type F	B
				CL	0.026	Type F	A
	Group D	none	0.00	ML	0.044	Type F	J
				GM	0.065	Type F	I
The Rock (ro)	Group C/D	none	0.00	SC	Peaty	Type F	J
				SC	0.024	Type F	C
				SP	0.040	Type F	J
				SP	0.047	Type F	I
Roping Pole (rp)	Group D	none	0.00	CL	0.025	Type D	B
				CH	0.014	Type D	F
				CH	0.010	Type D	G&F
Vincent Road (vi)	Group B	none	0.00	SM-ML	0.055	Type F	J
				ML	0.070	Type D	I
				CL	0.039	Type F	B
	Group B/C	none	0.00	ML	0.062	Type F	J
				CL	0.069	Type F	I
				CL	0.034	Type D	D
Waverley (wa)	Group B/C	none	0.00	ML	0.044	Type F	J
				ML	0.065	Type F	B
				CL	0.026	Type F	A
				CH	0.019	Type F	C
Woomabrigong (wo)	Group C	none	0.00	SM	0.034	Type F	J
				CL	0.036	Type F	B
				CL	0.015	Type F	A
				CL	0.020	Type F	A
Yarragundry (ya)	Group B/C	none	0.00	SM	0.046	Type F	J
				SC	0.033	Type F	B
				SM	0.045	Type F	J
				SM	0.050	Type F	J
				SM	0.051	Type F	J
				CL	0.018	Type F	C
				CL	0.017	Type F	A
				CL	0.023	Type F	A
				CL	0.025	Type D	A
				SC	0.034	Type D	B
				CH	0.016	Type D	H&F
				ML-OL	0.045	Type F	J

* Low risk, not no risk

Table C24. Canberra Soil Landscapes

Soil landscape	Common constraints	Slope range (%)	Soil hydrologic group	Acid sulfate risk	USCS class	K-factor USLE	Sediment type	Sediment basin wall construction (earth)
Allianonyyiga (al)	steep slopes with frequent rock outcrop, permanently high water tables in drainage areas, localised waterlogging on lower slopes, weak dispersible subsoil and hardsetting topsoil	20 to 40	Group C	none	OL	0.034	Type F	J
					SM-ML	0.030	Type D	J
					SM	0.045	Type D	B&I
					ML	0.046	Type F	A
					ML	0.056	Type F	B
					ML	0.060	Type F	D
Burra (ba)	erodible footslopes with high run-on; generally infertile, hardsetting topsoils with weak or dispersible subsoils common	5 to 30	Group C	none	SM	0.027	Type F	J
					SM-ML	0.031	Type D	J
					SM	0.047	Type F	J
					CL	0.058	Type F	C
					CL	0.037	Type D	B
					SM	0.051	Type D	J
Bennison (be)	generally erodible, shallow stony infertile soils, occurring frequently on steep slopes subject to mass movement and rock outcrop,	10 to 40	Group C	none	SM	0.026	Type F	J
					SM	0.021	Type F	J
					SM	0.046	Type F	J
					SC-CL	0.042	Type D	C
					CL	0.046	Type D	B
					GM-SM	0.008	Type C	J
Bullen Range (bg)	generally steep, stony, erodible, hillslopes with frequent rock outcrop and low water holding capacity; localised waterlogging, seepage, salinity and gully erosion affecting lower areas; infrequent mass movement on steepest slopes	>25	Group D Group C	none	SM	0.024	Type F	J
					CL	0.023	Type F	A
					SM-ML	0.028	Type F	J
					SM	0.038	Type F	B&I
Bollara (bo)	shallow hard-setting soils with low wet strength; arranged on low rolling hills with seasonal waterlogging and scalding in valleys and lower slopes; localised salinity and rock outcrop	10 to 30	Group C	none	CL	0.042	Type D	B
					SM	0.042	Type D	B
Bywong (by)	shallow, infertile soils with high erodibility and abrupt rock outcrop; hard-setting, high run-on to lower slopes contributing to high erosion and salinity hazards; dispersible subsoils	3 to 20	Group B Group C	none	SM	0.037	Type F	J
					SM-ML	0.041	Type D	J
					SM	0.046	Type D	J
					CL	0.028	Type D	A
					SM-ML	0.054	Type D	J/E
					ML	0.056	Type D	B
Bungendore (bz)	hardsetting, dispersible soils on poorly drained footslopes, general waterlogging and localised salinity	<5	Group B/C	none	ML	0.062	Type D	J
					ML	0.062	Type F	A
					CL	0.043	Type F	B

Table C24. Canberra Soil Landscapes (continued)

Table 24 Canberra Soil Landscapes									
Soil landscape	Common constraints	Slope range (%)	Soil hydrologic group	Acid sulfate risk	USCS class	K-factor USLE	Sediment type	Sediment basin wall construction (earth)	
Campbell (ca)	rounded, steep, stony hills with rock outcrops, terracettes and vertical tufts; shallow soils are hardsetting, infertile and erodible; localised waterlogging associated with weak impermeable subsols on lower slopes	>20	Group B/C	none	ML OL ML SM CH CL	0.053 0.018 0.042 0.036 0.054 0.039	Type D Type F Type D Type F Type F Type F	J J I I C D	
Celeys Creek (cc)	low rolling hills, granite tors; shallow, infertile, permeable, coarse grained topsoils; subsols display poor water holding, and seasonal waterlogging	10 to 32	Group B	none	SM SM SM SM SC-CL SC	0.023 0.027 0.022 0.027 0.025 0.022	Type F Type D Type D Type F Type F Type F Type D	J J J J B B	
Coopers (cp)	remnant dunes and beaches; deep, coarse erodible topsoils with poor water holding; localised seasonal waterlogging and water table pollution associated with poorly draining subsols; some wind erosion	na (est 30)	Group A Group B	none	SM-ML SM SM SM SM SM ML	0.011 0.025 0.016 0.025 0.036 0.061	Type D Type D Type D Type F Type F Type F Type D	J J J J J K D	
Clear Range (cr)	rugged mountains with steep slopes, rock outcrop and granite tors; sporadic rock falls and mass movement; coarse freely-draining soils; high run-on to lower slopes	>20	Group B Group C	none	SM SM SM SM SM	0.033 0.032 0.049 0.030 0.047	Type F Type D Type F Type D Type F	J J J J J	
Foxlow (fo)	steep, stony colluvial slopes; highly erodible shallow soils, localised waterlogging and rock outcrop	>20	Group D Group C	none	SM SM SM ML SC	0.028 0.022 0.040 0.053 0.037	Type F Type D Type F Type D Type F	J J J D B	
Franklin (fr)	erodible topsoils, poorly-drained, dispersible subsoil; high run-on, frequent waterlogging	2 to 5	Group C	none	ML SC SC CH ML ML	0.042 0.049 0.038 0.022 0.048 0.058	Type F Type F Type F Type D Type D Type D	J B B G J B	

Table C24. Canberra Soil Landscapes (continued)

Soil landscape	Common constraints	Slope range (%)	Soil hydrologic group	Acid sulfate risk	USCS class	K-factor USLE	Sediment type	Sediment basin wall construction (earth)
Ginninderra Creek (gc)	undulating floodplain; poorly drained; high run-on, flood prone areas; high erodibility; low wet strength	<3	Group C/D	none	CL	0.021	Type D	G
Gundaroo (gt)	narrow floodplains; poor drainage; high run-on, flood prone areas; highly erodible; low wet strength	<3	Group C	none	ML	0.049	Type F	J
					CL	0.046	Type D	B
					CL	0.043	Type D	D
					ML	0.041	Type F	J
					ML	0.053	Type F	B
					ML	0.051	Type F	J
					ML	0.079	Type D	D
					ML	0.059	Type F	E
					CL	0.043	Type F	A
					CL	0.043	Type F	A
Halfway Creek (hf)	confined flowlines; poor drainage; high run-on, concentrated flow; flood prone areas; highly erodible; low wet strength	<3	Group C	none	ML	>0.060	Type D	J
					ML	0.050	Type D	A
					ML	0.066	Type D	B
					ML	0.055	Type D	J
					ML	0.052	Type D	A
					ML	0.052	Type D	B
					CH	0.033	Type D	D
					ML	0.043	Type F	J
					ML	0.045	Type F	A
					CL	0.054	Type F	B
Hammonds Hill (hh)	shallow soils with intermittent rock outcrop; localised waterlogging; highly erodible soils; low strength subsoils	>20	Group B/C	none	OL	0.028	Type F	J
					CL	0.027	Type F	G
					SM-ML	0.058	Type F	I
					CH	0.018	Type D	F
Hoskinstown (hs)	shallow soils with frequent rock outcrop; seasonal waterlogging and localised saline scalding; highly erodible; poorly drained plastic clay subsoils have low wet strength	2 to 10	Group B/C	none	SM	0.043	Type F	J
					CH	0.069	Type F	C
					CH	>0.079	Type F	C
					ML	0.045	Type D	J
					CL	0.052	Type D	D
Jones Point (jp)	highly erodible soils with dispersible subsoils; saline seeps and low wet strength subsoils	<1	Group C	none	SC-CL	0.039	Type D	J
					SC	0.040	Type D	D
					SM	0.026	Type F	J

Table C24. Canberra Soil Landscapes (continued)

Table 24 Canberra Soil Landscapes									
Soil landscape	Common constraints	Slope range (%)	Soil hydrologic group	Acid sulfate risk	USCS class	K-factor	USLE	Sediment type	Sediment basin wall construction (earth)
Lake George Escarpment (le)	steep slopes, shallow stony soils and frequent rock outcrops; mass movement and rockfall hazards; high erodibility; run-on concentrated in poorly drained alluvial fans;	32 to 56	Group B/C	none	GM-SM	Peaty		Type C	J
					GM-SM	0.043	Type F	J	
					ML	0.028	Type F	J	
					CL	0.032	Type D	A	
					ML	0.043	Type D	A	
Luxor (lu)	colluvial slopes; poor drainage, localised waterlogging; some low wet-strength plastic clay subsols with some dispersible and saline examples;	<20	Group B	none	SM	0.030	Type F	J	
					SM	0.032	Type D	J	
					CH	0.020	Type F	A	
					ML	0.095	Type F	C	
Molonglo (mg)	poorly drained floodplain with some plastic clays subsols, permanently high water tables and seasonal waterlogging; highly erodible soils; concentrated run-on, flood hazards; polluted sediments; low wet strength	<3	Group C	none	OL	0.025	Type F	J	
					CL	0.046	Type D	B	
					CL	0.050	Type D	B	
					CL	>0.093	Type F	C	
Macanally Mountain (mm)	steep stony terrain with shallow soils; highly erodible hard-setting soils with dispersible subsols;	10 to 30	Group B/C	none	SM	Peaty	Type F	J	
					ML	0.049	Type D	E	
					CL	0.030	Type D	B	
					SC-CL	0.033	Type F	B	
					CL	0.058	Type F	C	
					SM	0.034	Type F	J	
Millpost (mp)	localised poor drainage and flood hazard, permanently high watertables and seasonal waterlogging; concentrated surface flows; localised salinity and seepage flows; dispersible subsols with low wet strength	<2	Group C	none	ML	0.057	Type F	J	
					ML	>0.077	Type D	E	
					CL	0.026	Type D	D	
					CL	0.026	Type D	E	
					CL	0.026	Type D	E	
Mills Cross (mx)	stagnant areas of hard-setting erodible topsoils with frequently dispersible subsols; some localised water logging and salinity;	<3	Group C/D	none	OL	>0.040	Type D	J	
					ML	>0.066	Type F	B	
					CH	0.031	Type D	F	
					CH	0.026	Type D	F	
					ML	>0.058	Type D	J	
					CL	0.064	Type D	B	
Paddy's River (pct)	erodible, non cohesive coarse soils; highly susceptible to gully erosion; localised wind erosion	na	Group A	none	SP-SM	0.000	Type C	J	
					SM	0.009	Type C	I	

Table C24. Canberra Soil Landscapes (continued)

Soil landscape	Common constraints	Slope range (%)	Soil hydrologic group	Acid sulfate risk	USCS class	K-factor USLE	Sediment type	Sediment basin wall construction (earth)
Pialligo (pi)	coarse, infertile, non-cohesive, wind-blown sediment ; extremely erodible materials subject to high run-on and flooding; seasonal waterlogging;	<3	Group B/C	none	SP	0.000	Type C	J
					ML	0.032	Type F	J
					ML	0.045	Type F	A
					ML	0.037	Type F	J
					CL	0.032	Type F	G
					ML	0.043	Type F	A
					ML	0.043	Type F	A
					ML	0.052	Type F	J
					SM	0.027	Type F	B&I
					SM-ML	0.038	Type F	B&I/A
Queanbeyan (qn)	steep slopes; infertile shallow stony soils; soils susceptible to sheet and gully erosion; localised seasonal waterlogging	10 to 25	Group B	none	ML	0.052	Type F	I
					ML	0.036	Type F	A
					SM	0.028	Type F	J
					SM	0.023	Type D	J
					ML	0.031	Type D	B
					SM	0.026	Type F	J
					SM	0.049	Type F	J
					CL	0.040	Type D	A
					SM	0.023	Type F	J
					SM	0.011	Type C	J
Round Hill (rh)	shallow, infertile, stony soils with low water holding capacity; rock outcrop common; steep rocky slopes susceptible to mass movement and rockfall	>20	Group D	none	SM	0.040	Type F	J
					SM	0.017	Type F	J
					SM	0.023	Type F	I
					CL	0.038	Type F	A
					ML	0.049	Type F	J
					ML	0.051	Type D	J
					ML	0.069	Type F	I
					CH	0.076	Type F	H
					ML	0.079	Type F	I
					CH	0.033	Type D	E
Taylors Creek (tc)	rock outcrop and granite tors, shallow hardsetting , infertile soils; low water holding capacity; high run-on and seasonal waterlogging	5 to 10	Group B/C	none	ML	0.044	Type F	J
					ML	0.031	Type C	J
					SM	0.034	Type D	J
					ML	0.066	Type D	E
					SC-CL	0.028	Type D	G
					SC-CL	0.036	Type F	B
					ML	0.044	Type F	J
					SM	0.031	Type C	J
					SM	0.034	Type D	J
					ML	0.066	Type D	E
Tharwa (th)	rock outcrop and tors; hard-setting, infertile soils with low water-holding capacity; poorly drained subsoil with localised dispersibility; high run-on and seasonal waterlogging	3 to 20	Group D	none	ML	0.044	Type F	J
					SM	0.031	Type C	J
					SM	0.034	Type D	J
					ML	0.066	Type D	E
					SC-CL	0.028	Type D	G
					SC-CL	0.036	Type F	B
					ML	0.044	Type F	J
					SM	0.031	Type C	J
					SM	0.034	Type D	J
					ML	0.066	Type D	E

Table C24. Canberra Soil Landscapes (continued)

Soil landscape	Common constraints	Slope range (%)	Soil hydrologic group	Acid sulfate risk	USCS class	k-factor	USLE	Sediment type	Sediment basin wall construction (earth)
			Group C		ML	0.041		Type D	J
					ML	0.056		Type D	B
Williamsdale (wi)	highly erodible soils; localised hard-setting surfaces and dispersible subsoils; high run-on contributing to seasonal waterlogging and localised flooding; overclearing and die-back in evidence	<10	Group D	none	SM	0.025		Type F	J
					OL	0.038		Type F	J
					SM	0.040		Type D	J
					CL	0.028		Type F	B
					ML	0.060		Type D	D
					CL	0.062		Type D	D
			Group D		OL	0.034		Type F	J
					CL	0.055		Type F	A
Winnunga (wn)	highly erodible infertile soils with dispersible subsoils; high run-on contributing to gully erosion, localised high water tables, seasonal waterlogging, salinity and seepage scalding	3 to 10	Group B	none	SM-ML	0.040		Type F	J
					OL	0.021		Type F	J
					ML	0.052		Type F	D
					ML	0.060		Type D	D
					CH	0.015		Type F	G
					CL	0.047		Type D	D
					CH	0.020		Type F	G

Table C25. Braidwood Soil Landscapes

Soil landscape	Common constraints	Slope range (%)	Soil hydrologic group	Acid sulfate risk	USCS class	K-factor USLE	Sediment type	Sediment basin wall construction (earth)
Allianoyonyiga (al)	generally steep slopes; localised shallow soils and rock outcrop upslope; high run-on, waterlogging in low areas; localised high erosion hazard	20 to 40	Group C	none	OL ML ML MH CL	Peaty 0.054 0.054 0.059 0.033	Type F Type D Type D Type D Type D	J B B B B
Brushy Hill (bh)	generally rocky; localised non cohesive soils, widespread wind erosion hazard	10 to 32	Group B	none	SM SM CH CL	0.028 0.023 0.022 0.017	Type F Type D Type F Type D	J J C A
Lower Boro (br)	localised high run-on and waterlogging; widespread incidence of seasonal waterlogging; localised shallow soils, rock outcrop and high erosion hazards; localised non cohesive soils and wind erosion	<20	Group C	none	SM-SC SM SC	0.027 0.037 0.029	Type F Type F Type D	J J B
Butmaroo (bt)	steep slopes, shallow soils with localised rock outcrop; high erosion hazard; localised mass movement	>20	Group C	none	CL CL SM SM SC-CL	0.032 0.020 Peaty 0.028 0.037	Type F Type F Type F Type F Type D	A C J J D
Braidwood (bw)	localised shallow soils and rock outcrop upslope; high run-on, permanently high waterlogging, waterlogging in low areas; localised high water erosion hazard; non cohesive soils and localised wind erosion hazards	0 to 15	Group C	none	SM SM CH SC SM-SC CL	0.025 0.028 0.015 0.028 0.027 0.018	Type F Type F Type F Type D Type F Type D	J J G D J/B B
Celeys Creek (cc)	widespread seasonal waterlogging; localised non cohesive materials; shallow profiles	10 to 32	Group C	none	SM SM CL	0.043 0.052 0.033	Type F Type F Type F	I J A
Cooper (cp)	widespread wind erosion hazard on non cohesive soils; high run-on, waterlogging in low areas	<3	Group B	none	SP SP CL	0.049 0.063 0.020	Type F Type F Type F	J J G
Currowan (cu)	localised shallow soils; waterlogging in some low areas; localised risks to foundations	<20	Group C	none	PT ML-CL ML-CL SC	Peaty 0.034 >0.084 0.020	Type F Type D Type F Type F	J D D J

Table C25. Braidwood Soil Landscapes (continued)

Soil landscape	Common constraints	Slope range (%)	Soil hydrologic group	Acid sulfate risk	USCS class	K-factor USLE	Sediment type	Sediment basin wall construction (earth)
Durran Durra (dd)	shallow soils and rock outcrop upslope; high run-on and seasonal waterlogging in low areas; localised threats to foundations	10 to 30	Group C	none	SC PT ML-CL ML CH	0.025 Peaty 0.052 0.061 0.021	Type F Type F Type D Type D Type D	B J D D D
Duckfield Hut (dh)	widespread seasonal waterlogging; localised shallow soils, rock outcrop and seepage scalds; localised risks to foundations	5 to 15	Group B/C	none	OL SM CL CL	0.042 0.056 0.027 0.027	Type F Type D Type D Type D	J J G E
Eastfields Creek (ea)	generally high run-on to low areas; permanently high waterables, seasonal waterlogging and flooding widespread; localised non cohesive soils; localised high erosion hazard; general risks to foundations	<10	Group B/C Group C/D	none	ML ML ML ML-CL CL	0.053 0.045 0.061 0.047 0.033	Type F Type D Type D Type D Type D	A B J D D
Fairy (fa)	steep slopes and shallow soils; localised water erosion hazards; mass movement on step areas; high run-on in some low areas; extreme risks to foundations	>20	Group D	none	SM-ML ML CL SM ML CL	Peaty 0.034 0.028 0.041 0.052 0.038	Type F Type D Type D Type F Type D Type D	J D B J B D
Hammonds Hill (hh)	generally steep slopes and localised rock outcrop; localised high erosion hazard; high run-on and seasonal waterlogging in some low areas; widespread threat to foundations	>20	Group D	none	ML CL ML-CL	0.052 0.042 0.060	Type F Type F Type F	J B B
Hollow Wood (hw)	localised rock outcrop and seasonal waterlogging	5 to 25	Group B/C Group C	none	PT CH ML CH	Peaty 0.071 0.033 0.020	Type F Type F Type D Type F	J C J G
Illogan Park (ip)	widespread shallow soils and localised seepage scalds; seasonal waterlogging in low areas; localised areas of high erosion hazard	< 10		none	SM SM-SC CL	0.035 0.039 0.056	Type F Type F Type F	J I C
Kalbilli (ka)	high run-on and seasonal waterlogging in low areas; widespread high erosion hazard; general risks to foundations	<20	Group C	none	SM-ML SM CH	0.056 0.061 0.025	Type F Type F Type D	J I A

Table C25. Braidwood Soil Landscapes (continued)

Soil landscape	Common constraints	Slope range (%)	Soil hydrologic group	Acid sulfate risk	USCS class	K-factor USLE	Sediment type	Sediment basin wall construction (earth)
Kamleh (km)	localised pockets of non cohesive soils and rock outcrop; high run-on to some low areas; localised areas of high erosion hazard	<12	Group C	none	SM SM SC-CL	0.039 0.050 0.040	Type F Type F Type F	J J B/A
Larbert (a)	generally high run-on, seasonal waterlogging and flooding in lower areas; localised non cohesive soils and generally high wind erosion hazard; general risks to foundations	<5	Group B/C	none	SM SM CL SC SC MH MH CL ML-CL	0.055 0.069 0.044 0.038 0.042 0.062 >0.075 0.043 0.052	Type F Type D Type D Type F Type F Type F Type D Type D Type D	J J D I I J D E E
Lake Bathurst (lb)	high run-on, waterlogging and flooding in lower areas; localised risks to foundations	<3	Group B	none	SM SC SC SC SC	0.026 0.022 0.011 0.012 0.021	Type F Type C Type D Type D Type D	J I I I E
Mount Budawang (mb)	generally steep slopes; shallow soils and rock outcrop widespread; instances of high water erosion hazard; high run-on to some low areas; general risks to foundations	20 to 40+	Group C	none	SM CL OL SC CL	0.028 0.030 0.015 0.026 0.030	Type F Type F Type C Type F Type D	J B J B B
Misery Mountain (mi)	generally steep slopes and widespread rock outcrops; localised shallow soil; instances of mass movement hazard; high run-on in low areas; general risks to foundations	>20	Group C/D	none	SM SC-ML CL	0.010 0.024 0.027	Type F Type D Type D	J D D
Moura Creek (mk)	localised shallow soils and rock outcrop; non cohesive materials in parts; instances of high erosion hazard; seasonal waterlogging and flooding in some low areas; localised risks to foundations	5 to 15	Group C	none	ML ML CL ML ML-CL	0.054 0.073 0.028 0.058 0.050	Type F Type D Type D Type D Type D	J I A D B
Monga (mn)	localised steep slopes and high run-on to low areas; general risks to foundations	10 to 32	Group C	none	OL ML CL PT SM	Peaty 0.045 0.038 Peaty 0.049	Type F Type F Type F Type F Type F	J A C J J

Table C25. Braidwood Soil Landscapes (continued)

Soil landscape	Common constraints	Slope range (%)	Soil hydrologic group	Acid sulfate risk	USCS class	K-factor USLE	Sediment type	Sediment basin wall construction (earth)
Mongarlowe (mo)	localised shallow soils and rock outcrop upslope; widespread seasonal waterlogging in low areas	5 to 20	Group C	none	ML-CL CL ML-CL	0.038 0.087 0.041	Type F Type F Type F	J C A
Morass (ms)	localised shallow soils and rock outcrop upslope; high run-on and widespread seasonal waterlogging in low areas	3 to 10	Group C	none	ML CL CL ML CL CH	0.046 0.032 0.028 0.041 0.039 0.018	Type F Type F Type F Type F Type F Type F	J B C J B G
Oallen (oa)	localised areas of non cohesive soils and wind erosion; some shallow soils upslope; some permanently high waterables in low areas	<10	Group D	none	ML OL SM SM SC	0.044 0.024 0.023 0.026 0.030	Type D Type F Type F Type F Type F	J J J J I
Oorong (oo)	generally non cohesive soils, widespread wind erosion hazard; localised waterlogging in some low areas	na	Group A	none	OL SP SP SC CL	0.010 0.017 0.019 0.029 0.028	Type F Type C Type C Type F Type D	J J I B G
Palerang (pa)	generally steep rocky slopes; localised areas of shallow soils; high run-on in some low areas; widespread risks to foundations	>32	Group C	none	SM SM ML ML CL	Peaty 0.025 0.045 0.048 0.090	Type F Type F Type F Type D Type F	J J J B C
Sand Hills (sh)	non cohesive soils and high wind erosion hazards throughout; localised rock outcrops	5 to 10	Group B	none	SM SM SM CL	0.052 0.065 0.058 0.045	Type F Type F Type F Type D	J B&I J D
Sight Hill (si)	localised steep slopes, shallow soils and rock outcrops; high run-on and seasonal waterlogging in some low areas	20 to 40	Group B	none	OL GM-SM CL ML	0.027 0.057 0.042 0.045	Type F Type F Type D Type D	J J B B
Taylor's Creek (tc)	localised shallow soils and rock outcrop; instances of high erosion hazard; localised high run-on and widespread waterlogging in lower areas; localised non cohesive soils	5 to 10	Group C	none	SM-ML SM-ML CL	0.049 0.055 0.035	Type F Type D Type F	J I A

Table C25. Braidwood Soil Landscapes (continued)

Soil landscape	Common constraints	Slope range (%)	Soil hydrologic group	Acid sulfate risk	USCS class	K-factor USLE	Sediment type	Sediment basin wall construction (earth)
Tomboye (to)	widespread waterlogging and mass movement; localised shallow soils; risks to foundations throughout the area	<32	Group D	none	SM	0.058	Type F	J
					CL	0.031	Type D	B
					OL	0.034	Type F	J
					MH	0.058	Type F	I
					OL	Peaty	Type F	J
					ML	0.053	Type F	A
					OL	0.019	Type D	J
					CH	0.025	Type D	F
					OL	0.032	Type F	J
					SM	0.038	Type F	I
Turallo (tu)	localised steep slopes and shallow soils; high run-on and waterlogging in some low areas;	<20	Group C/D	none	SM	0.038	Type F	J
					SM	0.038	Type F	J
					SC	0.036	Type F	B
					SC	0.027	Type F	J
					ML	0.042	Type F	A
					CL	0.077	Type F	C
					SM	0.027	Type F	J
					SM-SC	0.034	Type F	J/B
					SM-SC	0.039	Type C	I
					CL	0.036	Type F	J
Tarrawarra (tw)	localised steep slopes, shallow soils, rock outcrops and seepage scalds; high run-on and seasonal waterlogging in some low areas; instances of non cohesive soils and wind erosion hazards; localised risks to foundations	<10	Group B	none	ML-CL	0.043	Type D	D
					CL	0.029	Type D	A
					SM	0.027	Type F	J
					SM-SC	0.034	Type F	J/B
					SM-SC	0.039	Type C	I
					CL	0.036	Type F	J
					ML-CL	0.043	Type D	D
					CL	0.029	Type D	A
					SM	0.049	Type F	J
					SM	0.064	Type F	J
Windellama (wi)	localised areas of mass movement	20 to 32	Group C	none	CL	0.026	Type F	A
					CH	0.039	Type D	F

Table C26. Michelago Soil Landscapes

Table 26 Michelago Soil Landscapes									
Soil landscape	Common constraints	Slope range (%)	Soil hydrologic group	Acid sulfate risk	USCS Class	K-factor USLE	Sediment type	Sediment basin wall construction (earth)	
Anembo (an)	widespread seasonal waterlogging; localised permanent waterlogging of low areas	<10	Group B	none	SW	0.030	Type F	I	
			Group B		SW	0.034	Type D	J	
			Group C		SW	0.040	Type F	J	
					CL	0.041	Type F	A	
					CL	0.042	Type F	A	
			Group B		CL	0.035	Type F	A	
					SM	0.045	Type F	J	
					SC	0.035	Type D	B	
Burra (ba)	high water and wind erosion hazards; high run-on to low areas, mass movement of steeper slopes; localised shallow soils	5 to 30	Group B/C	none	ML	0.028	Type F	J	
					GC-SC	0.051	Type F	I	
					SC	0.034	Type F	B	
					CL	0.029	Type F	C	
Big Badja (bb)	shallow soils and high erosion hazard; localised steep slopes subject to mass movement; localised waterlogging	5 to 35	Group B	none	SC	0.037	Type F	J	
					SC	0.023	Type F	C	
					SC	0.029	Type F	B	
					SM	0.038	Type F	J	
					SM	0.045	Type D	J	
			Group B		SM	0.028	Type F	J	
			Group C		PT	Peaty	Type F	J	
					CL	0.031	Type D	A	
					CL	0.044	Type D	B	
Bredbo (bd)	subject to wind and water erosion hazards; uplands with localised shallow soils, rock outcrop, non cohesive soils; high run-on and localised waterlogging in some low areas	5 to 25	Group D	none	CL-ML	0.048	Type F	J	
					SC-SM	0.033	Type F	I	
			Group C		SC	0.031	Type F	I	
					CL	0.041	Type F	A	
			Group C		ML	0.050	Type F	A	
			Group B		SC	0.035	Type F	I	
			Group B		ML-CL	0.041	Type F	I	
			Group B/C		ML	Peaty	Type F	A	
					SC	0.029	Type F	B	
					ML	0.041	Type F	A	
					SP	0.029	Type C	J	
Bennison (be)	shallow soils, rock outcrop upslope; high run-on in low areas; mass movement and localised rock falls	10 to 40	Group C/D	none	SC-CL	0.029	Type F	J	
					SC-CL	0.056	Type F	B	
					SC	0.046	Type D	B	
					CL	0.054	Type D	B	
Bendemeer (bn)	high run-on to low areas; widespread seasonal waterlogging and flooding; localised wind erosion	<10	Group C	none	ML	0.045	Type F	I	
					CL	0.040	Type F	C	

Table C26. Michelago Soil Landscapes (continued)

Table 26 Michelago Soil Landscapes									
Soil landscape	Common constraints	Slope range (%)	Soil hydrologic group	Acid sulfate risk	USCS Class	K-factor USLE	Sediment type	Sediment basin wall construction (earth)	
Bollara (bo)	shallow soils, rock outcrop upslope; high run-on in low areas; mass movement and localised rock falls	10 to 30	Group C	none	OL	0.024	Type F	J	
					CL	0.037	Type D	B	
					CL	0.035	Type D	B	
					SC	0.043	Type F	B	
Campbell (ca)	shallow soils, rock outcrop upslope; high run-on in low areas; mass movement and localised rock falls	10 to 30	Group C	none	ML	0.037	Type F	J	
					MH	0.063	Type D	D	
					CL	0.051	Type D	D	
					ML	0.066	Type D	D	
					ML	0.037	Type F	A	
					ML	0.043	Type D	B	
Caleys Creek (cc)	steep slopes, shallow soils and rock outcrop; high run-on to low areas with localised high water table conditions; wide spread steep slopes, localised mass movement	>20	Group B/C	none	OL	0.034	Type F	J	
					ML	0.060	Type D	I	
					CL	0.039	Type D	A	
					CL	0.033	Type D	A	
					SM	0.028	Type F	I	
					SM	0.052	Type D	J	
Captains Flat (cf)	widespread rockiness; some steep slopes and shallow soils underlying localised erosion hazards; low areas subject to localised high water table and waterlogging conditions	10 to 32	Group B/D	none	SC	0.030	Type F	B	
					SM	0.045	Type D	J	
					SC	0.035	Type F	B	
					ML	0.040	Type F	J	
					GM	0.026	Type F	J	
					MH	0.055	Type D	D	
Cosgrove (co)	shallow soils upslope; widespread waterlogging and localised flood hazards on low areas	<15	Group C/D Group C	none	CL	0.035	Type D	B	
					SC	0.040	Type F	I	
					ML	0.052	Type F	B	
					GC	0.034	Type F	B	
					ML	0.049	Type F	A	
					CL	0.037	Type F	B	
Clear Range (cr)	widespread mass movement on steep slopes; localised shallow soils	5 to 30	Group C	none	ML	0.038	Type F	J	
					ML	0.024	Type F	A	
					CL	0.013	Type F	A	
					CL	0.023	Type F	C	
					SC	0.028	Type F	J	
					SC	0.035	Type F	I	
Clear Range (cr)	steep slopes mass movement, shallow soils and rock outcrop underlying widespread high water erosion hazard; localised non cohesive soils; high run-on to low areas	>20	Group B/D	none	SC	0.039	Type F	I	
					SC	0.026	Type F	B	

Table C26. Michelago Soil Landscapes (continued)

Table 26 Michelago Soil Landscapes									
Soil landscape	Common constraints	Slope range (%)	Soil hydrologic group	Acid sulfate risk	USCS Class	K-factor USLE	Sediment type	Sediment basin wall construction (earth)	
Foxlow (fo)	steep slopes mass movement, shallow soils and rock outcrop underlying widespread high water erosion hazard; high run-on to low areas;	>20	Group C/D	none	SM	0.051	Type F	J	
					GM	Peaty	Type C	J	
					SM	0.054	Type F	J	
					SM	0.051	Type D	J	
					CH	0.027	Type F	A	
					SC	0.031	Type F	I	
			Group B/C		MH	0.055	Type D	B	
					CL	0.054	Type D	B	
Gungoandra (gn)	shallow soils and steep slopes contribute to high erosion hazard and high run-on to low areas	<50	Group C	none	SM	0.039	Type F	I	
					CL	0.037	Type F	A	
					CL	0.028	Type D	A	
Murrumbidgee Gorge (go)	steep slopes mass movement, shallow soils and rock outcrop underlying widespread high water erosion hazard; high run-on to low areas;	>32	Group D	none	SM	0.037	Type F	J	
Gudgenby (gu)	widespread waterlogging and flooding hazards; localised non cohesive soils	3 to 10	Group B	none	GM	0.039	Type F	J	
					SM	0.040	Type F	J	
					CL	0.020	Type D	A	
					GM	0.060	Type F	J	
			Group C		ML	0.022	Type F	J	
					CL	0.039	Type F	C	
Lyons Creek (lc)	widespread wind and water erosion hazards; non cohesive soils; high run-on to all low areas	5 to 30	Group B/C	none	MH	0.049	Type F	J	
					MH	0.072	Type F	E	
					CL	0.030	Type F	C	
					CL	0.038	Type F	B	
					CL	0.046	Type F	A	
					GC	0.034	Type F	B	
			Group C/D		ML	0.039	Type F	J	
					ML	0.064	Type D	D	
Livingstone (li)	localised steep slopes, shallow soils, rockiness upslope; localised seasonal waterlogging in low areas	10 to 35	Group B	none	ML	Peaty	Type F	I	
					SC	0.030	Type F	I	
					SC	0.036	Type F	I	
			Group C/D		MH	0.049	Type D	J	
					CL	0.033	Type F	A	
Murrumbucca Creek (mc)	high wind and water erosion hazards; localised rock outcrop	5 to 10	Group B/D	none	SC	0.046	Type F	J	
					SC	0.045	Type F	I	
					CL	0.044	Type F	C	

Table C26. Michelago Soil Landscapes (continued)

Table 26 Michelago Soil Landscapes									
Soil landscape	Common constraints	Slope range (%)	Soil hydrologic group	Acid sulfate risk	USCS Class	K-factor USLE	Sediment type	Sediment basin wall construction (earth)	
Mount Dowling (md)	steep slopes, shallow soils and rock outcrop; non cohesive soils;	>20	Group C/D	none	SC	0.038	Type F	B	
						0.032	Type D	A	
Macanally Mountain (mm)	steep slopes mass movement, shallow soils and rock outcrop underlying widespread high water erosion hazard; high run-on to low areas	10 to 30	Group C/D	none	ML	0.040	Type F	J	
					SP	0.055	Type F	J	
					SM	0.058	Type F	J	
					ML	Peaty	Type F	J	
					CL	0.048	Type F	A	
Mount Colinton (mn)	steep slopes, shallow soils and rock outcrop; widespread mass movement; non cohesive soils; localised seasonal waterlogging in low areas	>20	Group C/D	none	CL	0.045	Type D	B	
					MH	0.058	Type F	B	
					CL	0.051	Type F	B	
					GP	Peaty	Type C	J	
					GP	Peaty	Type C	I	
					SP	0.051	Type C	J	
					SW	0.049	Type F	J	
					GW	0.032	Type C	J	
					SP	0.037	Type F	J	
					CL	0.028	Type D	A	
Nundora (nu)	shallow soils and rock outcrop; high erosion hazard; high run-on to any low areas	3 to 30	Group D	none	SM	0.031	Type F	J	
					SM	0.055	Type F	J	
					SC	0.024	Type F	B	
Onslow (on)	widespread water erosion hazard; seasonal waterlogging; localised shallow, non cohesive soils and rock outcrop	10 to 32	Group D	none	SM	0.042	Type F	J	
					SM	0.040	Type F	J	
					CL	0.027	Type F	A	
Round Hill (rh)	steep slopes mass movement, shallow soils and scattered rock outcrop underlying widespread high water erosion hazard	>20	Group D	none	SP	0.020	Type C	J	
					SP	0.033	Type C	J	
					SM	0.038	Type F	J	
					SM	0.046	Type F	J	
					SC	0.028	Type D	B	
Roberts Mountain (rm)	steep slopes and shallow soils; high erosion hazard; high run-on to some low areas	10 to 30	Group B	none	ML	0.024	Type F	C	
					SC-CL	0.063	Type F	C	
					GM	0.027	Type F	J	
					GM	0.070	Type D	J	
			ML	0.020	Type F	C			

Table C26. Michelago Soil Landscapes (continued)

Table 26 Michelago Soil Landscapes													
Soil landscape	Common constraints	Slope range (%)	Soil hydrologic group	Acid sulfate risk	USCS Class	K-factor USLE	Sediment type	Sediment basin wall construction (earth)					
Schofields Creek (sc)	shallow soils and scattered rock outcrop; high water erosion hazard	10 to 15	Group D	none	MH	0.057	Type F	I					
					PT	Peaty	J						
					SC	0.040	Type D	B					
					CL	0.037	Type F	A					
					SC	0.031	Type F	I					
					SC	0.034	Type D	D					
					SP	0.023	Type F	J					
					CL	0.085	Type F	C					
					MH-CL	0.037	Type D	J					
					MH	0.055	Type D	I					
Strike-a-light (sl)	generally non cohesive soils; widespread seasonal waterlogging	<15	Group B	none	SC-ML	0.029	Type F	J					
					SM	0.038	Type F	J					
					CL	0.020	Type D	B					
					SM	0.046	Type F	J					
					CL	0.038	Type D	A					
					CH	0.063	Type F	C					
					SM	0.048	Type F	J					
					SC	0.043	Type D	D					
					SC	0.034	Type D	B					
					Smiths Road (sr)	high water erosion hazards; localised shallow soil, non cohesive materials and rock outcrop	20 to 50	Group B/D	none	SM	0.048	Type F	J
SC	0.043	Type D	D										
SC	0.034	Type D	B										
ML	Peaty	A											
CL	0.034	Type F	A										
ML	0.015	Type F	C										
SC	Peaty	C											
CL	0.060	Type F	C										
CL	0.024	Type F	A										
Spring Vale (sv)	localised shallow soils and rock outcrops; localised erosion hazards; some local high watertable and waterlogging conditions	10 to 32	Group C/D	none						SM	0.034	Type F	J
					SC	0.038	Type F	I					
					CL	0.010	Type D	A					
					CL	0.029	Type F	A					
					CL	0.043	Type D	B					
					SM	0.034	Type F	J					
					PT	Peaty	J						
					SM	Peaty	J						
					MH	0.037	Type F	J					
					SM	0.035	Type F	J					
Tallaganda (ta)	widespread steep slopes, non cohesive soils, rock outcrop; some localised mass movement and rock falls	>20	Group C	none	SC	Peaty	C						
					CL	0.060	Type F	C					
					CL	0.024	Type F	A					
					SM	0.034	Type F	J					
					SC	0.038	Type F	I					
					CL	0.010	Type D	A					
					CL	0.029	Type F	A					
					CL	0.043	Type D	B					
					Tharwa (th)	generally high run-on to low areas, localised seasonal waterlogging; localised shallow soils; localised non cohesive materials	3 to 20	Group C	none	SM	0.034	Type F	J
										SC	0.038	Type F	I
CL	0.010	Type D	A										
CL	0.029	Type F	A										
CL	0.043	Type D	B										
SM	0.034	Type F	J										
PT	Peaty	J											
SM	Peaty	J											
MH	0.037	Type F	J										
SM	0.035	Type F	J										
Tinderry (ti)	steep slopes and mass movement; shallow soil and rock outcrop underlying high erosion hazard in some areas; localise high run-on, high watertables and seasonal waterlogging in some low areas; general threat to foundations	20 to 25	Group D	none	SM	Peaty	J						
					PT	Peaty	J						
					SM	Peaty	J						
					MH	0.037	Type F	J					
					SM	0.035	Type F	J					

Table C26. Michelago Soil Landscapes (continued)

Soil landscape	Common constraints	Slope range (%)	Soil hydrologic group	Acid sulfate risk	USCS Class	K-factor USLE	Sediment type	Sediment basin wall construction (earth)
Williamsdale (wi)	general wind erosion hazard; high run-on and seasonal waterlogging affects low areas	<10	Group B/C	none	SC	0.041	Type F	B
					SM	0.030	Type F	J
					ML	0.051	Type D	I
					CL-ML	0.049	Type D	B
					SM	0.051	Type D	J
					SC	0.036	Type D	D

Table C27. Cooma Soil Landscapes

Table 27 Cooma Soil Landscapes													
Soil landscape	Common constraints	Slope range (%)	Soil hydrologic group	Acid sulfate risk	USCS class	K-factor USLE	Sediment type	Sediment basin wall construction (earth)					
Amaroo (am)	high erosion hazard; localised shallow soils	12 to 32	Group B	none	MH	0.059	Type F	I					
					MH	0.058	Type F	I					
					CL	0.070	Type F	I					
					CL	0.073	Type F	I					
					CL	0.067	Type F	I					
					SC-CL	0.064	Type F	I					
					MH	0.060	Type F	I					
					SC-ML	0.044	Type F	I					
					SC-ML	0.064	Type F	I					
					CL	0.055	Type D	D					
Anembo (an)	localised high water table and waterlogged conditions; seasonal waterlogging throughout area; localised threats to foundations	6 to 10	Group B	none	SM	0.031	Type F	I					
					SM	0.036	Type F	I					
					SC	0.035	Type F	I					
					SC	0.032	Type D	I					
					SM-SC	0.051	Type F	I					
					SC	0.039	Type F	B					
					CL	0.069	Type F	I					
					ML	0.055	Type F	I					
					SC-CL	0.040	Type F	B/A					
					PT	Peaty	Type F	J					
Big Badja (bb)	shallow soils and high erosion hazard; localised steep slopes subject to mass movement; localised waterlogging; localised threats to foundations	3 to 32	Group B-D Group B	none	SM	0.018	Type F	I					
					SC	0.031	Type F	I					
					SC	0.021	Type F	I					
					SM-SC	0.048	Type F	I					
					SC	0.030	Type F	C					
					SM	0.028	Type F	B&I					
					Barkersdale Creek (bc)	steep slopes, shallow soils and rock outcrop; high erosion hazard; high run-on to low areas; general threat to foundations	15 to 40	Group D Group B	none	SM	0.049	Type F	J
										SM	0.045	Type F	I
										SC-ML	0.052	Type F	B/A
										MH	0.062	Type F	I
MH	0.061	Type D	I										
CL	0.038	Type F	A										
ML	0.057	Type F	C										
SC	0.051	Type F	B										
SM	0.054	Type F	I										

Table C27. Cooma Soil Landscapes (continued)

Table 27 Cooma Soil Landscapes													
Soil landscape	Common constraints	Slope range (%)	Soil hydrologic group	Acid sulfate risk	USCS class	K-factor USLE	Sediment type	Sediment basin wall construction (earth)					
Bredbo (bd)	subject to wind and water erosion hazards; uplands with localised shallow soils, rock outcrop, non cohesive soils; high run-on and localised waterlogging in some low areas; localised threats to foundations	3 to 10	Group D	none	SM	0.037	Type C	I					
					SC	0.033	Type F	I					
					SC-ML	0.032	Type F	B/A					
					CL	0.090	Type F	I					
					SC	0.053	Type D	B					
					SC	0.033	Type F	I					
					SC	0.031	Type F	B					
					SC	0.014	Type F	I					
					ML	0.041	Type F	A					
					SM	0.045	Type D	J					
					SC	0.032	Type F	B					
					CL	0.047	Type F	B					
Bullnamang Gap (bg)	widespread steep slopes, shallow soils, rock outcrop underlying high erosion hazard; localised mass movement; high run-on to some low areas; general threat to foundations	15 to 56	Group D	none	SC	0.040	Type F	I					
					ML	0.029	Type F	A					
					CL	0.037	Type D	B					
					SC	0.028	Type F	I					
					SC-ML	0.034	Type F	I					
					SC	0.037	Type F	I					
					SC	0.039	Type F	I					
					CL	0.038	Type F	B					
					ML-CL	0.028	Type F	G					
					SC	0.035	Type F	B					
					Binjura (bj)	general erosion hazard; localised shallow soils, rock outcrop and non cohesive soils; localised threats to foundations	10 to 15	Group D	none	SC	0.037	Type F	I
										SC	0.039	Type F	I
CL	0.038	Type F	B										
ML-CL	0.028	Type F	G										
SC	0.035	Type F	B										
SC	0.034	Type F	I										
GM	0.041	Type C	J										
CL	0.012	Type F	C										
CL	0.044	Type F	B										
CL	0.041	Type F	B										
CL	0.025	Type F	C										
CL	0.051	Type F	B										
Bobundara (bn)	generally shallow soils and high erosion hazard; localised steep slopes; high run-on to low areas; localised threats to foundations	7 to 32	Group C/D	none	SC	0.034	Type F	I					
					GM	0.041	Type C	J					
					CL	0.012	Type F	C					
					CL	0.044	Type F	B					
					CL	0.041	Type F	B					
					CL	0.025	Type F	C					
					CL	0.051	Type F	B					
					CL	0.044	Type F	C					
					CL	0.033	Type D	D					
					Brothers (br)	steep slopes, shallow soils and localised rock outcrop underlying generally high erosion hazard; localised mass movement; high run-on to low areas; general threat to foundations	15 to 32	Group B	none	CL	0.023	Type F	B
										CL	0.020	Type F	G
										CL	0.017	Type F	C
ML	0.038	Type F	A										
CL	0.023	Type F	B										
CL	0.020	Type F	G										
CL	0.017	Type F	C										
ML	0.038	Type F	A										
CL	0.023	Type F	B										
CL	0.020	Type F	G										
CL	0.017	Type F	C										
ML	0.038	Type F	A										

Table C27. Cooma Soil Landscapes (continued)

Table 27 Cooma Soil Landscapes									
Soil landscape	Common constraints	Slope range (%)	Soil hydrologic group	Acid sulfate risk	USCS class	K-factor USLE	Sediment type	Sediment basin wall construction (earth)	
Black Snake Creek (bs)	widespread steep slopes, shallow soils and rock outcrop contributing to high erosion hazard; high run-on to some low areas; localised mass movement; general threat to foundations	10 to 40	Group D Group B	none	SW	0.038	Type F	I	
					SC	0.033	Type F	I	
					SP	0.034	Type F	J	
					CL	0.020	Type F	A	
					SC-CL	0.036	Type D	B	
					SM-SC	0.043	Type F	B&I/B	
Big Willow (bw)	general wind and water erosion hazards; some localised shallow soils and rock outcrop; localised risk to foundations	20	Group B/D	none	SM	0.031	Type F	I	
					SC	0.042	Type F	I	
					SC-ML	0.034	Type F	I	
					CL	0.029	Type F	A	
					SC	0.040	Type F	I	
					SM	0.024	Type F	I	
Celeys Creek (cc)	widespread rockiness; some steep slopes and shallow soils underlying localised erosion hazards; low areas subject to localised high water table and waterlogging conditions; localised threats to foundations	8 to 33	Group B	none	SM	0.024	Type F	I	
					SC	0.041	Type F	I	
					SC	0.029	Type F	I	
					SC	0.030	Type F	C	
					SC	0.035	Type F	B	
					SM	0.024	Type F	I	
Cranky Dans Creek (cd)	widespread shallow soils and localised rock outcrop underlies generally high erosion hazard; localised threats to foundations	12 to 25	Group B	none	SM	0.024	Type F	I	
					ML-CL	0.033	Type F	I	
					MH	0.058	Type F	I	
					SC-CL	0.028	Type F	B/A	
					SM	0.043	Type F	B&I	
					ML	0.045	Type F	A	
Cloyne Limestone Hills (cl)	mixture of shallow, non cohesive soils and rock outcrop underlies generally high wind and water erosion hazards	5 to 15	Group D Group C	none	CL	0.043	Type D	B	
					SC-CL	0.027	Type F	B/A	
					ML-CL	0.038	Type F	B	
					ML	0.051	Type F	A	
					CL	0.048	Type F	B	
					MH	0.063	Type D	A	
Clear Range (cr)	steep slopes mass movement, shallow soils and rock outcrop underlying widespread high water erosion hazard; localised non cohesive soils; high run-on to low areas; general threat to foundations	>20	Group D Group B	none	CL	0.026	Type F	K	
					ML-CL	0.027	Type F	G	
					SC	0.028	Type F	I	
					SC	0.035	Type F	I	
					SC	0.039	Type F	I	
					SC	0.026	Type F	B	

Table C27. Cooma Soil Landscapes (continued)

Soil landscape	Common constraints	Slope range (%)	Soil hydrologic group	Acid sulfate risk	USCS class	K-factor USLE	Sediment type	Sediment basin wall construction (earth)
Dairymans Plain (da)	localised high run-on to low areas; seasonal waterlogging and flooding widespread; high erosion hazard	<7	Group C/D	none	SM	0.051	Type F	J
Dry Farm (df)	shallow soils underlying high erosion hazard; localised threats to foundations	2 to 20	Group C/D	none	ML	0.043	Type F	I
							Type F	I
							Type F	A
							Type F	I
							Type F	I
							Type F	A
							Type F	A
							Type F	I
							Type F	I
							Type F	I
Dromore (dr)	generally high wind and water erosion hazards	<10	Group C	none	SC	0.033	Type F	I
							Type F	I
							Type C	I
							Type F	I
							Type F	I
							Type F	C
							Type F	I
							Type F	I
							Type F	I
							Type F	C
Duck Hole Creek (du)	high erosion hazard; localised threats to foundations	6 to 20	Group B	none	CL	0.040	Type D	D
							Type F	C
							Type F	A
							Type F	J
							Type D	D
							Type F	B
							Type F	C
							Type F	I
							Type F	K
							Type F	B
Foxlow (fo)	steep slopes mass movement, shallow soils and rock outcrop underlying widespread high water erosion hazard; high run-on to low areas; general threat to foundations	40	Group B Group D	none	SC	0.034	Type D	D
							Type C	J
							Type F	J
							Type F	J
							Type F	J
							Type F	J
							Type F	J
							Type F	J
							Type F	J
							Type F	J

Table C27. Cooma Soil Landscapes (continued)

Table 27 Cooma Soil Landscapes									
Soil landscape	Common constraints	Slope range (%)	Soil hydrologic group	Acid sulfate risk	USCS class	K-factor USLE	Sediment type	Sediment basin wall construction (earth)	
Murrumbidgee Gorge (go)	steep slopes mass movement, shallow soils and rock outcrop underlying widespread high water erosion hazard; high runoff to low areas; general threat to foundations	>56	Group B	none	SM	0.051	Type D	J	
					CH	0.027	Type F	G	
					SC	0.031	Type F	I	
					MH	0.055	Type D	B	
					CL	0.054	Type D	B	
Kydra Peaks (ky)	steep slopes, shallow soils and rock outcrop underlying widespread high water erosion hazard; localised non cohesive soils; general threat to foundations	>25	Group D	none	SM	0.011	Type F	J	
					MH	0.048	Type D	D	
					MH	0.062	Type F	I	
Maneroo (ma)	non cohesive soils underlying high wind erosion hazard; localised shallow soil and rock outcrop contributing to localised erosion hazards; general threat to foundations	1 to 10	Group D	none	ML	0.022	Type F	I	
					CL	0.014	Type F	H	
					CL	0.026	Type F	A	
					ML-OL	0.034	Type F	J	
					CL	0.011	Type D	G	
					SC	0.010	Type F	K	
					CL	0.042	Type F	B	
					CL	0.033	Type F	G	
					GC	0.022	Type C	I	
					SC	0.027	Type F	B	
Murrumbidgee (mb)	widespread wind and water erosion hazards; flood hazard; seasonal waterlogging in some low areas; localised non cohesive soils; general threat to foundations	<3	Group B	none	MH	0.047	Type D	A	
					SC	0.040	Type F	I	
					ML	0.053	Type F	C	
					CL-MH	0.041	Type F	B/A	
					SM	0.038	Type F	I	
					SC	0.041	Type F	B	
					ML	0.042	Type F	C	
					SC-SM	0.032	Type F	I	
					SC	0.046	Type F	I	
					SC	0.045	Type F	I	
Murrumbucca Creek (mc)	high wind and water erosion hazards; localised rock outcrop; localised threats to foundations	5 to 10	Group D Group B	none	CL	0.044	Type F	C	
					SC	0.038	Type F	B	
					CL	0.032	Type D	A	

Table C27. Cooma Soil Landscapes (continued)

Table 27 Cooma Soil Landscapes									
Soil landscape	Common constraints	Slope range (%)	Soil hydrologic group	Acid sulfate risk	USCS class	K-factor USLE	Sediment type	Sediment basin wall construction (earth)	
Middle Flat (mf)	generally high wind and water erosion hazards; localised high run-on to low areas	<5	Group C	none	ML-CL SC CL-CH ML	0.026 0.039 0.040 0.035	Type F Type F Type F Type F	B B C A	
Mount Gladstone (mg)	shallow soils and rock outcrop underlying high erosion hazard; localised high run-on to low areas; general threat to foundations	10 to 32	Group B/C Group B	none	SW SM-SC SC SC SC SC SC	0.023 0.032 0.053 0.036 0.038 0.040	Type F Type F Type F Type F Type F Type F	J I I I B I	
Mittagang Road (mi)	generally high wind and water erosion hazards; localised high run-on to low areas	<3	Group B Group B	none	SC SC SC-ML SC SC	0.045 0.036 0.039 0.042 0.033	Type F Type F Type F Type F Type F	I B B/A I I	
Macanally Mountain (mm)	steep slopes mass movement, shallow soils and rock outcrop underlying widespread high water erosion hazard; high run-on to low areas; general threat to foundations	10 to 32	Group D Group C	none	SM CL SC-ML SM MH CL	0.037 0.049 0.047 0.064 >0.079 0.046	Type F Type D Type F Type F Type D Type F	J D B/A J D B	
Muddah (mu)	high wind and water erosion hazards; localised shallow soil, non cohesive materials and rock outcrop; localised threats to foundations	3 to 10	Group D Group C	none	ML ML ML SM-SC CL ML-MH CL SC	0.031 0.048 0.042 0.055 0.039 0.059 0.040 0.048	Type F Type F Type F Type F Type F Type F Type F Type F	I I I I B I A I	
Myalla Road (my)	widespread shallow soils and rock outcrop underlying high erosion hazards; localised threats to foundations	5 to 33	Group D Group C Group D Group B	none	SC SC MH SC CL	0.033 0.033 0.051 0.045 0.040	Type F Type F Type D Type F Type F	I I B I A	

Table C27. Cooma Soil Landscapes (continued)

Table 27 Cooma Soil Landscapes									
Soil landscape	Common constraints	Slope range (%)	Soil hydrologic group	Acid sulfate risk	USCS class	K-factor USLE	Sediment type	Sediment basin wall construction (earth)	
Numeralla (nl)	high erosion hazard related to localised shallow soils; high run-on to low areas; localised risks to foundations	5 to 10	Group B	none	ML-CL	0.044	Type F	I	
					MH	0.058	Type F	B	
					CL	0.044	Type F	B	
					ML-MH	0.049	Type F	I	
Oakvale (oa)	high wind and water erosion hazards; localised high run-on to low areas	<8	Group B	none	SC	0.030	Type F	I	
					SC	0.034	Type F	I	
					SC	0.034	Type F	B	
					ML-OL	Peaty	Type F	J	
					ML-CL	0.041	Type F	B	
					SC	0.038	Type F	B	
Pine Hut Flat (ph)	shallow soils underlying high erosion hazard; high run-on to some low areas; localised threats to foundations	<20	Group B	none	ML-CL	0.050	Type F	I	
					SP	0.042	Type F	I	
					CL	0.063	Type F	K	
Rock Flat Creek (rf)	shallow soils, rock outcrops with localised steep slopes underlying high erosion hazard; general threats to foundations	10 to 32	Group D	none	SC	0.019	Type C	I	
					SC	0.034	Type F	I	
					SC	0.033	Type F	I	
					CL	0.027	Type F	A	
					SC	0.035	Type F	B	
					SC-CL	0.031	Type D	B	
					SW	0.018	Type F	J	
					SC	0.026	Type F	I	
					SC	0.028	Type F	I	
					Round Hill (rh)	steep slopes mass movement, shallow soils and scattered rock outcrop underlying widespread high water erosion hazard; general threat to foundations	>20	Group B/D	none
SC	0.022	Type C	I						
SM	0.044	Type F	J						
SC	0.023	Type D	D						
SC	0.028	Type D	B						
Roberts Mountain (rm)	steep slopes and shallow soils underlying high erosion hazard; high run-on to some low areas; localised threats to foundations	10 to 33	Group D Group B	none	ML	0.024	Type F	C	
					SC-CL	0.063	Type F	I	
					GM	0.027	Type F	I	
Rose Valley (rv)	high wind and water erosion hazards; localised shallow soils	3 to 20	Group B/C	none	GM	0.070	Type D	J	
					SP	0.050	Type F	I	

Table C27. Cooma Soil Landscapes (continued)

Table 27 Cooma Soil Landscapes									
Soil landscape	Common constraints	Slope range (%)	Soil hydrologic group	Acid sulfate risk	USCS class	K-factor USLE	Sediment type	Sediment basin wall construction (earth)	
	and rock outcrop; high run-on to some low areas; localised threats to foundations				ML	0.054	Type F	B	
					CL	0.035	Type D	D	
					SC	0.043	Type F	I	
					SC	0.024	Type F	C	
					CL	0.043	Type D	D	
					SW	0.034	Type F	J	
					SC	0.024	Type C	I	
					SC	0.036	Type F	B	
Sapling Creek (sa)	steep slopes mass movement, shallow soils and rock outcrop underlying widespread high water erosion hazard; high run-on to low areas; general threat to foundations	15 to 40	Group D	none	ML-CL	0.041	Type F	I	
			Group B		MH	0.044	Type F	A	
					ML	0.056	Type F	I	
					CL	0.041	Type F	C	
					ML	0.047	Type F	I	
					CL	0.035	Type F	A	
					CL	0.015	Type F	A	
Schofields Creek (sc)	shallow soils and scattered rock outcrop underlying high water erosion hazard; general threat to foundations	<20	Group D	none	ML	Peaty	Type F	A	
					PT	Peaty	Type F	J	
					MH	0.033	Type F	I	
			Group B		MH-CL	0.037	Type D	D	
					SC	0.040	Type D	B	
					ML	0.046	Type D	B	
					CL	0.086	Type F	I	
					CL	0.037	Type F	A	
					SC	0.031	Type F	I	
					SC	0.039	Type F	I	
			Group B/C		SC	0.034	Type D	D	
					SP	0.020	Type F	J	
					SP	0.023	Type F	J	
					CL	0.085	Type F	I	
					CL	0.043	Type F	A	
					MH	0.055	Type D	E	
Slacks Creek (sk)	high erosion hazard related to localised shallow soils; localised risks to foundations	6 to 12	Group D	none	ML-OL	0.051	Type F	J	
			Group B		SC-ML	0.043	Type F	I	
					SC	0.059	Type F	I	
					CL	0.055	Type F	B	
					CL	0.087	Type F	I	
					CL	0.045	Type F	A	
					SM-SC	0.042	Type F	J/B	

Table C27. Cooma Soil Landscapes (continued)

Table 27 Cooma Soil Landscapes									
Soil landscape	Common constraints	Slope range (%)	Soil hydrologic group	Acid sulfate risk	USCS class	K-factor USLE	Sediment type	Sediment basin wall construction (earth)	
Smiths Road (sr)	high water erosion hazards; localised shallow soil, non cohesive materials and rock outcrop; localised threats to foundations	20 to 33	Group B	none	SM SC SC	0.048 0.043 0.034	Type F Type D Type D	J D B	
Spring Vale (sv)	localised shallow soils and rock outcrops; localised erosion hazards; some local high waterable and waterlogging conditions; localised threats to foundations	10 to 32		none	ML CL	Peaty 0.034	Type F Type F	A A	
Tinderry (ti)	steep slopes and mass movement; shallow soil and rock outcrop underlying high erosion hazard in some areas; localise high run-on, high waterables and seasonal waterlogging in some low areas; general threat to foundations	32 to 70	Group D Group B	none	SP PT SM SC MH SM SC SC ML-CL CL CL SC-CL	0.006 Peaty 0.025 0.026 0.037 0.035 0.041 Peaty 0.033 0.036 0.040	Type F Type F Type F Type F Type F Type F Type F Type F Type F Type F Type D Type F	J J I B I J B I C B C	
Upper Cooma Creek (uc)	non cohesive soils, high wind and water erosion hazards; high waterables, seasonal waterlogging and flooding in low areas, general threat to foundations	na	Group C	none	CL CL CL CL	0.011 0.029 0.021 0.020	Type F Type D Type D Type F	H K K G	
Wadbilliga (wa)	steep slopes mass movement, shallow soils and rock outcrop underlying widespread high water erosion hazard; non cohesive soils; high run-on to some low areas; general threat to foundations	32 to 56	Group D	none	PT SC GC	Peaty 0.029 0.034	Type F Type F Type F	J B I	
Wathonga (wt)	high erosion hazard; localised shallow soils and rock outcrop; localised high waterables and waterlogging of some low areas; localised risks to foundations	6 to 15	Group B/D Group C	none	SM ML CL ML MH CL	0.029 0.060 0.049 0.045 0.077 0.056	Type F Type F Type D Type F Type D Type D	I I D I E D	

Table C28. Narooma Soil Landscapes

Table 28 Narooma Soil Landscapes							
Soil landscape	Soil hydrologic group	Percent area of high acid sulfate soil risk	Acid sulfate risk	USCS Class	K-factor USLE	Sediment type	Sediment basin wall construction (earth)
				CL	0.032	Type D	J
				CH	0.044	Type D	D
	Group C/D			ML	0.044	Type F	B
				CL	>0.094	Type F	K
				CL	0.033	Type D	D
				SP	0.000	Type C	J
Murrah (mu; mub; muc)	Group B/C	0.57 (mub)0 (muc) 0	sporadic (mub) none (muc) none	OL	0.038	Type F	J
				SM	0.037	Type D	J
				SM	0.042	Type D	J
	Group B			CH	0.018	Type D	A
				OL	Peaty	Type F	J
				SP	0.036	Type F	J
Nangudga (na)	Group D	82.02	endemic	OL	Peaty	Type D	J
				OL	0.047	Type D	J
				ML	0.043	Type D	D
	Group C/D			PT	Peaty	Type D	J
				ML	0.047	Type F	A
	Group C			SP	0.005	Type C	J
				OL	0.034	Type F	J
				ML	0.051	Type D	J
				SP	0.009	Type F	I
				CL	0.051	Type D	D
Pambula (pa)	Group C/D	0.64	sporadic	SM	0.007	Type F	J
				CL	0.066	Type F	C
	Group B/C			SM	0.014	Type F	J
				SM	0.041	Type F	nt
				CL	0.048	Type D	D
Quondolo (qu)	Group B	0.00	none	SP	Peaty	Type F	J
				SP	0.032	Type D	nt
				SC	0.052	Type F	C
Sheringham Lane (sl)	Group C/D	0.35	sporadic	OL	Peaty	Type D	J
				CH	0.022	Type D	H
Tathra (ta)		1.48	frequent	SP	0.000	Type C	I
				SP	0.003	Type C	J
	Group A			SP	Peaty	Type C	J
				SP	0.000	Type C	J
				SP	0.000	Type C	I
				SP	0.000	Type C	I
				SP	0.007	Type C	J
				SP	0.005	Type C	I
				SP	0.000	Type C	I
Trunketabella Flat (tf)	Group B/C	46.54	frequent	OL	>0.043	Type D	J
				OL	>0.046	Type D	J
				ML	0.062	Type D	D
	Group B			SM	0.017	Type F	J
				ML	0.050	Type F	J
				ML	0.067	Type F	I
	Group C			SP	0.016	Type F	J
				ML	>0.061	Type F	J
Tanja (tj)	Group B	1.58	sporadic	SM	0.023	Type F	J
				CH	0.029	Type D	B
				CL	0.039	Type D	B

Table C28. Narooma Soil Landscapes (continued)

Table 28 Narooma Soil Landscapes								
Soil landscape	Soil hydrologic group	Percent area of high acid sulfate soil risk	Acid sulfate risk	USCS Class	K-factor USLE	Sediment type	Sediment basin wall construction (earth)	
Bodalla (bd)	Group C	0.13	sporadic	SM	0.013	Type F	I	
				SM	0.015	Type F	J	
				CL	0.023	Type F	A	
	Group B/C			SM	0.019	Type F	J	
				SM	0.017	Type F	nt	
				CL	0.023	Type D	D	
Brou Lake (bl)	Group A	13.73	endemic	SP	0.000	Type C	J	
				SP	0.002	Type C	J	
				SP	0.000	Type C	J	
				SP	0.000	Type C	I	
				SM	0.004	Type F	J	
				SM	0.005	Type C	nt	
Bermagui River (bm)	inapplicable	91.32	endemic	ML	0.063	Type F	D	
				ML	0.059	Type F	D	
				ML	>0.054	Type F	A	
				ML	0.046	Type F	B	
Bingie (bn)	Group C/D	0.66	sporadic	ML	0.032	Type F	A	
				CH	0.017	Type F	G	
				SM	0.041	Type F	J	
	Group C			SC	0.016	Type F	B	
				CL	0.056	Type F	B	
Couria Creek (ck)	Group C/D	21.17	common	OL	0.037	Type D	J	
				SM	0.001	Type C	J	
	Group B			OL	0.040	Type F	J	
				ML	0.038	Type F	A	
				SM	0.048	Type D	J	
				SM	0.038	Type F	J	
				SM	0.005	Type C	I	
				ML	0.043	Type F	J	
				SM	0.038	Type F	I	
				SM	0.046	Type F	I	
				Group A	OL	0.025	Type F	J
				Group C	OL	0.017	Type F	J
					OL	>0.054	Type D	J
				ML	0.066	Type D	D	
				SM-ML	0.037	Type F	J	
				OL	Peaty	Type D	J	
CL	0.043	Type D	D					
Coila (co)	Group D	0.23	sporadic	CH	0.023	Type F	G	
				CH	0.017	Type F	H	
				SM	0.046	Type F	B&I	
				SM	0.044	Type F	J	
Gulaga (gu)	Group C/D	0.00	none	SM	Peaty	Type F	J	
				CL	0.036	Type F	C	
				CL	0.037	Type D	A	
Long Swamp (ls; lsa; lsb)	Group C/D	13.15 (lsb) 0	endemic (lsb) frequent	PT	Peaty	Type F	J	
				PT	Peaty	Type F	J	
				PT	Peaty	Type F	J	
				OL	0.034	Type D	J	
				OL	0.016	Type D	J	
				OL	0.027	Type D	J	
				PT	Peaty	Type F	J	
				OL	Peaty	Type F	J	
	Group D			OL	Peaty	Type F	J	

Table C28. Narooma Soil Landscapes (continued)

Table 28 Narooma Soil Landscapes							
Soil landscape	Soil hydrologic group	Percent area of high acid sulfate soil risk	Acid sulfate risk	USCS Class	K-factor USLE	Sediment type	Sediment basin wall construction (earth)
	Group B			OL	0.022	<i>Type F</i>	J
				CL	0.035	<i>Type F</i>	B
Tilba Tilba (tt)	Group C	0.00	sporadic	OL	0.027	<i>Type F</i>	J
				CL	0.041	<i>Type F</i>	B
				SM	0.062	<i>Type F</i>	J
				OL	0.016	<i>Type F</i>	J
				SC	0.020	<i>Type F</i>	A
				CL	0.024	<i>Type F</i>	G
				SM	0.041	<i>Type F</i>	B&I
Wagonga (wg; wga; wgb)	Group D	0.51 (wga) 3.472198500057 (wgb) 0	sporadic (wga) sporadic (wgb) none	SM-ML	0.037	<i>Type F</i>	J
				PT	Peaty	<i>Type D</i>	J
				PT	Peaty	<i>Type F</i>	J
				SM	0.049	<i>Type F</i>	B&I
				SM	0.055	<i>Type D</i>	J
				SM	0.040	<i>Type F</i>	K
				ML	0.057	<i>Type F</i>	D
				CH	0.066	<i>Type F</i>	C
				SM	0.031	<i>Type D</i>	J
				ML	0.071	<i>Type F</i>	I

Table C29. Bega-Goalen Point Soil Landscapes

Table C29 Bega-Goalen Point Soil Landscapes						
Soil landscape	Soil hydrologic group	Acid sulfate risk	USCS class	K-factor USLE (t.ha.h/ha.MJ.mm)	Sediment type	Sediment basin wall construction (earth)
Black Ada Swamp (ba)	inapplicable	endemic	PT	Peaty	Type F	J
			SC	0.000	Type C	I
			SP	0.000	Type C	I
			CL	Peaty	Type F	J
			CL	Peaty	Type F	J
Bemboka (be)	Group B/C	none	SC	0.034	Type F	I
			SC	0.027	Type C	J
			SC	0.034	Type F	D
			CL	0.016	Type F	A
			SM	0.038	Type F	J
	Group D	none	SM-SC	0.020	Type F	B&M/B
			SM	0.032	Type F	J
	Group B/C	none	SC	0.026	Type F	B
			ML	0.022	Type F	J
			SW	Peaty	Type F	J
Bald Hills (bh)	Group B/C	none	SC	0.016	Type F	J
			CL	0.028	Type F	A
			ML	0.025	Type F	A
			CL	0.054	Type D	D
Biamanga (bi)	Group B/C	none	SC	0.001	Type C	J
			CL	0.084	Type F	C
			SM	0.038	Type D	J
			SC	0.056	Type F	C
Bournda (bo)	Group C/D	none	SC	Peaty	Type F	J
			SC-ML	0.016	Type F	J
			SM	0.052	Type F	J
			SC	0.032	Type F	B
			SC-CL	0.066	Type F	C
			SM	0.026	Type F	J
Brogo Pass (bp)	Grou B/C	none	SC	0.013	Type F	B
			SM	0.024	Type F	I
			SM-SC	0.023	Type F	B&M/B
			CL	0.064	Type F	C
			ML	Peaty	Type F	A
Glenbog-Coolangubra (gc)	Group D	none	CL	0.072	Type F	C
			SC	0.034	Type F	I
			SC	0.045	Type F	B
			SC	0.021	Type F	J
			SC	0.032	Type F	J
			SC	Peaty	Type F	J
			SC	0.016	Type F	I
			SM-SC	0.011	Type F	I
			SC	0.000	Type F	J
			SC	0.029	Type F	B
Goalen Head (gh)	Group C	sporadic	CL	0.025	Type F	G
			CL	0.032	Type D	A
			CL	0.020	Type D	B
			CL	0.023	Type D	A
			CL	0.037	Type F	B
			CL	0.042	Type D	B
	Group B	sporadic	CL	0.031	Type D	nt
			SM	0.026	Type F	I

Table C29. Bega-Goalen Point Soil Landscapes (continued)

Table C29 Bega-Goalen Point Soil Landscapes						
Soil landscape	Soil hydrologic group	Acid sulfate risk	USCS class	K-factor USLE (t.ha.h/ha.MJ.mm)	Sediment type	Sediment basin wall construction (earth)
			SC	0.022	Type D	D
Jingo Creek (ji)	Group D	none	SM	0.033	Type F	J
			SM	0.060	Type F	J
			SM	0.019	Type F	J
			SM	0.049	Type F	J
			SC	0.033	Type F	B
Jellat Jellat Flat (jj)	Group B	sporadic	ML	0.039	Type F	J
			ML	0.036	Type F	A
			ML-CL	0.041	Type F	B
Kalaru (ka)	Group C	sporadic	SM	0.007	Type C	J
			SC	0.033	Type C	C
			ML	Peaty	Type F	J
	Group B	SM	0.025	Type F	J	
		SM	0.033	Type F	J	
		CL	0.024	Type D	B	
		SC	0.028	Type D	B	
		SC-ML	0.050	Type D	D/E	
Lower Brogo (lb)	Group B	none	SM	0.023	Type F	J
			SM	0.034	Type D	J
			SM	0.051	Type D	J
			SM	0.051	Type F	J
Mount Darragh (md)	Group B/C	none	CL	0.045	Type F	C
			ML	Peaty	Type F	C
			CL	0.031	Type F	G
Milligandi (mg)	Group B	sporadic	ML	0.059	Type F	J
			SC	0.050	Type D	I
	Group C		ML	0.033	Type F	J
			SM	0.051	Type D	J
Mumbulla Mountain (mm)	Group C/D	none	CL	0.034	Type D	A
			SM	0.018	Type C	I
			SC	Peaty	Type C	J
Meringola Peak (mp)	Group D	none	SC	0.000	Type C	C
			SM	0.035	Type F	J
	Group C		SC	0.024	Type F	I
			SC	0.024	Type F	J
			SC	0.028	Type C	I
			CL	0.028	Type D	G
			CL	0.038	Type D	J
			CL	0.031	Type D	B
	Group D		SC	0.021	Type F	J
			SC	0.021	Type F	J
Murrah (mu)	Group C/D	sporadic	ML	0.034	Type D	J
			CL	0.035	Type D	D
			MH	0.025	Type F	J
	Group C/D		MH	0.042	Type F	J
			ML	0.055	Type D	B
			CL	0.054	Type D	D
Numbugga-Buckajo Swamps (nb)	Group B	none	ML	0.019	Type F	J
			SC	0.009	Type C	I
	Group B		SC	0.008	Type C	J
			SC	0.003	Type C	I

Table C29. Bega-Goalen Point Soil Landscapes (continued)

Table C29 Bega-Goalen Point Soil Landscapes						
Soil landscape	Soil hydrologic group	Acid sulfate risk	USCS class	K-factor USLE (t.ha.h/ha.MJ.mm)	Sediment type	Sediment basin wall construction (earth)
Nullica-Gnupa (ng)	Group C/D	none	SC	0.034	Type F	I
			SC	0.031	Type F	I
			SC	0.032	Type F	I
			SC	0.044	Type F	I
			CL	0.040	Type F	B
Nelson Lagoon (nl)	Group D	endemic	ML	Peaty	Type F	J
			MH	0.042	Type F	A
			MH	>0.085	Type F	C
			ML	Peaty	Type F	J
	Group C	ML	Peaty	Type F	J	
		CL	0.050	Type D	D	
SM	0.038	Type F	J			
Pambula (pa)	Group B	sporadic	SW	0.023	Type F	J
			SW	0.026	Type F	I
			SC	0.022	Type F	C
			SC	0.047	Type F	I
			CL	0.036	Type D	D
			SM	0.017	Type F	J
			SM	0.039	Type F	J
	Group A	CL	0.016	Type D	A	
		SP	0.003	Type C	J	
		SP	0.000	Type C	J	
		SP	0.000	Type C	I	
		SP	0.018	Type C	J	
Pigeon Box Mountain (pb)	Group C	none	SM-SC	Peaty	Type F	B&I/B
			CL	0.042	Type D	D
	Group B		SC	Peaty	Type F	I
			SC	0.030	Type F	D
			SM	0.023	Type C	J
	Group D		SC	0.028	Type C	B
			SC	Peaty	Type C	I
			SC	0.002	Type C	I
Penooka Swamp (ps)	Group D	common	CL	0.035	Type F	B
			CH	0.027	Type F	C
Quoraburagun Pinnacles (qp)	Group A	none	SW	0.037	Type F	J
			SW	0.018	Type F	J
			SC	0.028	Type F	C
			CL	0.054	Type F	C
Tathra (ta)	Group A	common	SP	0.000	Type C	I
			SP	0.003	Type C	J
			SP	Peaty	Type C	J
			SP	0.000	Type C	J
			SP	0.000	Type C	I
			SP	0.000	Type C	I
			SP	0.000	Type C	I
	Group A		SP	0.007	Type C	J
			SP	0.005	Type C	I
SP	0.000	Type C	I			
Tantawangalo Escarpment (te)	Group C/D	none	SC	0.020	Type C	J
			SM-SC	0.028	Type F	J/B
	Group D		SC	0.012	Type F	I
			SC	0.039	Type F	B
			SC	0.030	Type F	C

Table C29. Bega-Goalen Point Soil Landscapes (continued)

Table C29 Bega-Goalen Point Soil Landscapes						
Soil landscape	Soil hydrologic group	Acid sulfate risk	USCS class	K-factor USLE (t.ha.h/ha.MJ.mm)	Sediment type	Sediment basin wall construction (earth)
Tanja (tj)	Group B		SC	0.012	Type F	I
			SC	0.026	Type F	I
	Group B	sporadic	OL	0.024	Type F	J
			ML	0.056	Type F	I
	Group D		CL	0.039	Type D	B
			OL	0.026	Type F	J
CL	0.030	Type F	C			
Towamba River (tr)	Group B	sporadic	SC	0.023	Type F	I
			SP	0.007	Type F	I
			SM	0.029	Type F	I
			SC	0.020	Type F	I
			OL	0.021	Type F	J
Tura (tu)	Group A/B	sporadic	SC	0.019	Type F	J
			SM	0.012	Type F	J
			SC	0.016	Type F	I
			SC-CL	0.002	Type F	B/A
			SP	0.000	Type C	I
Wadbilliga (wa)	Group D	none	SC	0.029	Type F	J
			GC	0.034	Type F	C
			PT	Peaty	Type F	J
Whipstick Creek (wc)	Group C/D	none	SC	0.026	Type F	B
			CL	0.030	Type F	A
			SM-SC	0.017	Type F	J
			SM-SC	0.035	Type F	J/B
			CL	0.054	Type F	C
			SM	0.013	Type C	nt
			CL	0.030	Type D	J
Wallagoot Foredune (wf)	Group A	widespread	SP	0.000	Type C	J
			SP	0.000	Type C	J
Wapengo Lake (wl)	inapplicable	widespread	SP	0.000	Type C	J
			SP	0.000	Type C	J
			ML	Peaty	Type F	B
Wolumla Creek (wo)	Group C	none	CL	0.026	Type F	G
			SC	0.031	Type F	A
			CH	0.021	Type F	J
			CL	0.027	Type D	B
			GC	0.000	Type C	I
			SC	0.005	Type C	I
			CH	0.020	Type D	H
			CL	0.043	Type D	E
			SC	0.036	Type F	J
Yellow Pinch (yp)	Group D	sporadic	SM	0.025	Type F	J
			SM	0.031	Type F	J
			SC	0.030	Type F	I
			SC	0.032	Type F	D
			CL	0.022	Type F	A
			CL	0.035	Type D	B
			CL	0.040	Type D	D
			MH	0.042	Type F	J
			CL	0.045	Type D	D
			CL	0.043	Type F	B



APPENDIX D

D Use of Erosion Control Products

Introduction

Erosion control products, particularly geosynthetic materials, are becoming increasingly popular for earth stabilisation, seepage control, pollution containment and other land-based applications to protect soils. They protect the soil from erosion by reducing raindrop impact, reducing the velocity of overland flow and increasing infiltration. Also, they minimise sediment and nutrient pollution of downslope lands and waterways.

These erosion control products have many advantages over traditional engineering practices, not the least of which is the enhancement and greater use of natural soil–water–plant systems. They include range of materials such as composted mulches that give the opportunity to use recycled materials in environmentally beneficial applications. Further, recycled materials reduce our impact on the environment by minimising the extraction of natural resources.

This section has been included to provide a broad insight into the scope and opportunities offered by erosion control products. However, to cover their diversity and complexity, grouping them into classes related to their manufacture and application has been necessary. This has limitations in that materials within a group can be quite different from one another and have completely different performance parameters at different sites. Some indication of the variety of applications offered by these products can be gleaned from the groupings in Table D1. These represent more than 160 materials available locally.

The intention here is to provide a simplified guide to the use of these products for soil and water management applications in Australia. Manufacturers and distributors all maintain comprehensive information and design services in support of their products and should be consulted for more detailed advice. The Australasian Chapter of the International Erosion Control Association (IECA) and Civil Contractors Federation can help with access to their affiliated manufacturers, distributors and suppliers.

Requirements of land designers, planners and contractors involved in soil and water management include:

- protecting soils from overland water flow
- stabilising soil surfaces against rainfall and erosion
- increasing infiltration
- reinforcing structurally unstable slopes
- controlling sediment-borne pollution
- improving seedbed moisture, temperature and stability
- enhancing vegetative growth in poor soil environments

-
- reinforcing root-holding ability on steep slopes and waterways
 - weed control
 - controlling unwanted seepage from landfill
 - stabilising streambanks
 - providing resistance to wave energy
 - improving pavement stability and longevity.

Table D1 offers a rating of the applicability of various groups of erosion control materials for the broad needs of designers, planners and contractors. It is intended as a strategic planning guide to the likely strengths and weaknesses of different groups of materials, and should help in gaining more relevant detailed advice from distributors and suppliers.

Organic Products

A range of organic products is derived from the composting of organic waste materials (predominantly garden wastes). Where these are claimed to be recycled products, they should comply with Australian Standard AS 4454 (2003) Composts, Soil Conditioners and Mulches. Commercially available products suitable for site rehabilitation works include composted mulches and soil conditioners, and organic soil blends. Properly composted materials are stable, free from disease and pathogens, and are in a form that benefits plant growth.

The main applications for organic products are:

- Composted coarse mulches: Applied as a surface covering, 50mm to 75 mm deep (50 tonnes per hectare) to control erosion and reduce runoff. Also reduces evaporation and plant stress, and suppresses weeds. Coarser particle sizes, i.e. greater than 15 mm diameter provide superior erosion control. Care is required in placing mulch in the path of concentrated runoff from upstream sources to avoid washout occurring. In such cases, anchoring might be required.
- Composted soil conditioners: Incorporated into on-site soils before respreading to improve soil condition and provide organic nutrients to boost plant growth. Also holds water and suppress plant diseases. Application rates need to suit plant nitrogen and phosphorus requirements.
- Manufactured soils: Soil blends prepared following AS 4419 (2003) Soils for Landscaping and Garden Use with maximum recycled content should be used where imported soils are required. The recycled organic content helps turf/plant establishment and growth, improves aeration, provides nutrients, holds water and suppresses diseases.

Only use recycled organic products that comply with the relevant Australian Standards. Compliance can be shown by one of the following ways:

- Australian Standards certified – At this level, the product has been

independently audited with quality testing and quality system in place. It offers the highest level of assurance.

- Quality endorsed company + batch test certificate – This level offers an independently audited quality system. Batch test certificates are available to show compliance.
- Batch test certificate – This level has a batch test certificate to show compliance. Note that certification must be done on a batch basis.

An “Electronic Product Selector” has been developed to help users select the correct product for their application. This and further information about these products can be accessed at The University of New South Wales’s Recycled Organics Unit website, <http://www.recycledorganics.com>.

Spray-on Erosion Control Materials

Spray-on blankets are convenient alternatives to erosion control blankets (ECB’s), particularly in difficult situations like steep inaccessible cut and fill batters or around trees and rock outcrops. Biodegradable mulch materials are carried along with seed, fertiliser and soil binder (soluble glue or bitumen emulsion) in a water-based slurry that can be sprayed to cover quite large areas from a truck-mounted machine. They make up a one-step operation that results in revegetation of otherwise quite poor seedbed conditions. They are generally used to enhance germination of desirable plants, but can be adjusted at application to gain weed control if required. It is not intended to cover commonly used binders here such as soluble bitumen or emulsion-based products.

Temporary, Degradable, Erosion Control Blankets (ECB’s)

These are ready-made rollout blankets constructed from materials that are biodegradable and/or photodegradable. They can provide temporary protection from overland flows, but this is ultimately limited to the capability of the permanent grass cover that will be established after they break down:

- (a) Biodegradable materials commonly used are jute, coir (coconut fibre), straw or wood shavings that might be enclosed in a net. Traditionally, this net has been nylon or PVC, i.e. this part not biodegradable; however, biodegradable nets are now available that are preferred as they are less likely to trap wildlife.
- (b) Photodegradable products are composed of polypropylene fibres. They break down over three to twelve months depending on climate and weather, during which time they protect the surface from raindrop splashes and enhance germination and establishment of seeds sown underneath.

Weed Control Blankets and Mats

Weed control blankets are of similar construction to biodegradable ECB's, but with a thicker mulch layer that prevents light from reaching the soil and promoting weed germination. They are used to support established seedlings and tubestocks by eliminating weed competition until the desirable plants can provide sufficient leaf shading to avert weed competition on their own.

Long Term Non Degradable Turf Reinforcing Mats (TRM's)

These are composed of non degradable materials that furnish erosion protection and extend the erosion control limits of vegetation for the design life of a project. Like ECB's, TRM's provide surface protection from rainfall and runoff, but have the extra facility of combining with the growing plants to reinforce the vegetation's resistance to overland flow. They are installed as an integrated system with a thin layer of seedbed material incorporated into them after fixing. Grasses established as waterway protection using TRM's continue to provide permanent protection from erosion even in high water flows. It is very important that the manufacturer's installation instructions are followed carefully and that TRM's are well anchored to the soil.

Geotextiles

Geotextiles are relatively thin, relatively strong, sheet materials manufactured from polypropylene or polyester fibres. They may be woven (similar to weed mats) or non woven. The stability of many work sites relies on maintaining stable earthen access. Stable pavement needs to be dry and rigid and permanently separated from plastic subgrades. Several geotextiles can maintain the necessary separation between free draining coarse rigid pavement materials and moist poorly draining fines. They achieve this by allowing passage to water, but not soil particles and by having sufficient strength to support the coarser grades and prevent their embedding in the underlying fines. These geosynthetics are used to great advantage where substrate materials have poor strength and drainage characteristics. They are laid over the substrate with coarse graded material on top to provide better pavement life and pollution protection.

Geotextiles are also used in a similar way to ECB's, particularly those that are UV-stabilised, non woven, and have masses of less than 200 grams per square metre. Like ECB's they control erosion from rain splashes and can even be used in temporary diversion channels with concentrated flow (if they are anchored properly). They are light, conform well to irregular surfaces and are relatively easy to deliver and fix to difficult sites. However, due to their close-knit nature, they will not promote vegetation from under seeding and they will need to be removed before final rehabilitation.

Sediment Fences

Sediment fences are one of the commonest techniques used on disturbed lands to capture sediment from overland water flows. They are built down slope of areas disturbed by construction activities, on posts or post and wire fencing, depending on whether it is a self-supporting type or not. Their effectiveness relies on being trenched into the ground to avert undermining. Contrary to popular belief, they are not designed to filter contaminated stormwater. Rather, they are designed to form a temporary barrier to sheet flow such that a stilling basin is formed behind. Suspended solids (particularly fractions coarser than silt) are allowed to settle and may be removed. Consequently, they should not be placed across concentrated flow.

Earth-filled Geotextile Tubes

Recent development of an old technique using sandbags for sediment capture has resulted in sediment barriers being constructed from sand enclosed in continuous geotextile tubing. The tubes are available in various lengths and provide a barrier approximately 150 mm to 200 mm in height.

Floating Sediment Barriers and Silt Curtains

A requirement to protect aquatic areas from sediment pollution leaving construction sites often entails the use of floating sediment barriers or silt curtains suspended in shallow shoreline waters. These are similar to normal sediment fences but they are supported in the water by floats and held vertical by weights. Similar to sediment fences, they are not designed to filter water, but are designed to act as a barrier to flow and form a stilling basin thereby allowing sediment to settle out of suspension. They might not need to extend right to the bed of the water.

Grout Injected Mats

Grout injected mats are prefabricated, two layered geotextile materials that allow concrete armouring to be formed in place and, therefore, meet a site's specific contours. The mats are laid on the surface, cut to fit, and pumped with grout. After the grout is set and cured, the geotextile forming breaks down under UV light to leave the concrete armouring, usually in a net-like pattern that helps vegetation grow in protected niches. The vegetation has the ultimate effect of softening and obscuring the appearance of the armouring for greater infiltration and aesthetic appeal.

Reinforced Turf

Reinforced turf can be grown in place by use of geosynthetic materials as described above (TRM's), or prepared offsite, lifted, rolled and transported onsite where it is rolled

out ready to go. A few geosynthetic-reinforced turf products are available that can be applied directly to high flow situations. These provide immediately high levels of vegetative protection against erosion by overland flow.

Articulated Concrete Mats

These are armouring systems made from separate concrete units joined by flexible geosynthetic links. They allow for movement that can absorb wave energy or subsidence in supporting substrata. They are most useful in steep situations to provide vehicle access for maintenance operations in waterline areas like waterways, sediment basins, gross pollutant traps and wetlands.

Unitary Reinforced Armouring Systems

Unitary reinforced armouring is made up of three-dimensional units assembled onsite and linked to form high levels of protection from erosion and slope instability. They have a high component of aesthetic appeal and environmental integration with vegetation and soils. They can produce wider community acceptance of stabilised cut-and-fill slopes by means of amenable textural treatments and special planting niches.

Cellular Soil Confinement

Cellular Soil Confinement products confine linked units of soil so that they cannot move (in a critical plane) independently from one another. They form a strongly integrated system of armour that allows for surface treatments with a range of materials including trees, grasses and shrubs, and gravel or sand to meet stability, infiltration (in porous pavements) or aesthetic objectives. Cellular Soil Confinement can also be used in multiple layers (with an appropriate fill) to reinforce embankments and provide slope stability in filled embankments.

Wind Barrier Fencing

Wind barriers are usually constructed from "loose weave" geosynthetic materials. They are ideally designed to have a 40 percent porosity that maximises the effective wind shadow of protective fencing. They are light and easily attached to boundary fencing where this is close to the areas requiring protection. These materials are often confused with geotextiles, silt fence and shade cloth and require precise specification and ordering.

Flexible Waterproof Membranes

These geosynthetic materials are designed to form impermeable barriers to liquids. They can be cut and joined onsite to form tailor-made reservoirs, or capping for water containment. Various reinforced and unreinforced materials are available for different applications. Mostly, they are all highly resistant to UV degradation and to most chemicals.

Vertical Soil-moisture Barriers

These are specialised systems for containing underground pollutants and preventing their escape to outside environments. They are constructed from interlocking high-density polyethylene (HDPE) modules that join to form watertight and gas-tight seals. They are suited to the control of methane and contaminated waters in industrial and landfill applications. Diaphragm wall techniques or single pass trenching can be used for their installation. Barriers penetrate naturally occurring impermeable horizons forming a watertight, gas-tight seal underneath that prevents leakage.

Geosynthetic Clay Liner (GCL's)

Sealing of earthen structures with swelling clay materials such as bentonite has been practised with varying success for many years. Composite geosynthetic materials, which incorporate the low hydraulic conductivity properties of bentonite with the structural properties of geotextiles, are known as GCL's. They are a means of ensuring a uniform distribution of bentonite is easily applied over a wide area. Materials are cut to fit the site, confined under an earthen overburden of at least 300 mm and allowed to moisten and swell. The resulting seal has a very low permeability, typically 5×10^{-11} m/s. They have great application in containing moisture and pollutants in situations such as landfills and ponds.

Subsurface Drainage Systems

Modern prefabricated subsurface drainage systems are composites of plastic drainage cores wrapped in geotextile filters. They are modular units with strip or box sections for easy alignment across the direction of flow. Specialised designs are available for drainage of retaining walls and revetments, subsoil drainage or drainage of roads, sports fields and racetracks.

Pipe Inlet Sediment Barriers

Sediment from construction sites is a major source of pollution and adds significantly to the maintenance expenditures of local authorities if it is allowed to enter trunk drainage systems. Many designs and products are available for preventing sediment gaining access to drop inlets and kerb inlets near construction sites. These use geosynthetic materials that separate sediment from stormwater before it can enter the trunk system and sensitive aquatic environments. Proprietary systems have the advantage of not interfering directly in public usage of the area and creating a safety hazard. However, they can temporarily exacerbate local flooding problems and may need specialised equipment for maintenance.

Wattles and Logs

The products are constructed from compressed, durable, organic materials such as straw, coir and jute. Available in logs up to approximately 300 mm in diameter, they provide localised support for soil layers, particularly at the edges of lakes or streams. They may also be placed along the contours of steep slopes to interrupt surface flow and reduce its erosive force. Ultimately they decompose after plants have become fully established. They represent part of a range of landscaping materials that provide a medium for reestablishing important riparian and wetland communities that control pollution and add aesthetic appeal. They support the biotechnology and soft engineering of bank and waterline areas associated with streams, estuaries and wetlands.

Hydraulic Soil Stabilisers

These are proprietary products manufactured from natural gums, polymers or hydrocarbons that penetrate the soil and bind the particles together. They are often diluted with water and sprayed onto the surface at various application rates depending on the soil type and the required design life. Typical design life is three to six months.

Table D1 Erosion Control products for stabilising disturbed lands

Erosion control practice	Type	Effect on vegetation				Controlling erosion and pollution									Constraints
		enhances germination of grass seeds	controls weeds	enhances growth of tubestock	reinforces root-holding ability	protects soil surfaces	reduces runoff	filters or traps sediment	stops seepage	reinforces steep slopes	resists waves	stable in low (<2 m/sec) channel flows	stable in high (>2 m/sec) channel flows	stabilises pavements	
ORGANIC PRODUCTS (can be recycled)															Might need anchoring
Composted Coarse Mulch	16 tonnes per hectare	1	1	1	0	3	3	2	0	0	0	0	0	0	
Composted Coarse Mulch	27 tonnes per hectare	0	2	3	0	3	3	3	0	0	0	0	0	0	
Composted Coarse Mulch	56 tonnes per hectare	0	3	3	0	3	3	3	0	0	0	0	0	0	
Composted soil conditioner	100 L per m ² (max)	3	1	3	2	1	1	0	0	0	0	0	0	0	Product needs incorporation into existing soil
Manufactured soils	150 L per m ² (max)	3	1	3	2	1	1	0	0	0	0	0	0	0	
SPRAY ON PRODUCTS															
Hydromulching	1.5 tonnes mulch + 300 litres binder per hectare	3	0	0	0	3	1	1	0	0	0	0	0	0	
Bonded Fibre	5 tonnes fibre per hectare	3	1	1	0	3	2	1	0	0	0	0	0	0	
ROLLED EROSION CONTROL PRODUCTS (RECPs)															Ensure RECP's have intimate contact with subsoils (good preparation), are well anchored and have check slots in conditions of concentrated flow
Biodegradable ECB's	Jute mesh	2	1	0	1	2	1	0	0	0	0	1	1	0	
	Coconut fibre mesh	2	1	0	1	2	1	1	0	0	0	1	1	0	
	Curled wood fibre in plastic mesh	3	1	1	1	3	2	1	0	0	0	1	1	0	Nets might trap fauna
	Jute matting (~350 gsm)	3	1	1	1	3	2	1	0	0	0	2	1	0	Allows weed growth
	Jute matting (~600 gsm)	0	3	3	0	3	2	1	0	0	0	2	1	0	Not for grass growth
	Coconut fibre matting (~400 gsm)	3	1	1	1	3	2	1	0	0	0	2	1	0	Allows weed growth
	Coconut fibre matting (~900 gsm)	0	3	3	0	3	2	1	0	0	0	2	1	0	Not for grass growth
Photodegradable ECB's	Mesh (< 5 mm openings)	2	0	0	1	2	1	0	0	0	0	1	0	0	Little moisture retention
	Super light weight nonwoven (~30gsm)	2	0	0	1	2	1	0	0	0	0	1	1	0	Little moisture retention; net (if included) can trap fauna
Non Biodegradable TRM's	Plastic fibres with netting	2	1	0	3	3	2	1	0	0	3	3	3	0	Ensure soil-filled
	Composite with biodegradable	2	1	0	3	3	2	1	0	0	3	3	3	0	Ensure soil-filled
HYDRAULIC SOIL STABILISERS															
	Polymers/Polyacrylamide (rate depends on type)	0	0	0	0	2	0	0	0	0	0	1	0	0	Needs water supply for application
	Bitumen emulsion (12,000 l/ha)	0	0	0	0	2	0	0	0	0	0	1	0	0	Environmental concerns
TEMPORARY SEEDING															
	Annual	0	1	0	0	3	2	2	0	0	0	1	0	0	Minimum 8 days to establish
	Perennial	0	2	0	0	3	2	2	0	0	0	1	0	0	Needs water supply
INSTANT TURF															
	Kikuyu	0	1	0	0	3	2	2	0	1	0	1	0	0	Needs water supply
	Reinforced turf (pregrown)	0	1	0	3	3	2	2	0	1	1	2	2	0	Needs water supply
OTHER PRODUCTS															
Straw (anchored)	4.5 tonnes per hectare	3	1	1	0	3	3	2	0	0	0	0	0	0	
Weed mat		0	3	1	0	3	0	0	0	0	0	0	0	0	Restricts air and moisture
Geotextile		0	1	1	1	2	0	2	0	2	0	2	1	3	See general note for RECP's above if used in channels
Sediment fences		0	0	0	0	0	1	2	0	0	0	0	0	0	
Earth-filled geotextile tubes		0	0	0	0	0	0	3	0	0	0	0	0	0	Low profile
Floating sediment barriers		0	0	0	0	0	0	3	0	0	1	0	0	0	
Grout injected mats		0	1	0	0	3	0	0	1	0	2	3	3	0	Rigid structure
Gabion Mattresses		0	0	0	0	3	0	0	0	0	3	3	3	1	
Articulated concrete mats		0	0	0	0	3	0	0	0	0	3	3	2	0	
Reinforced armouring systems		0	0	0	0	3	0	0	0	0	3	3	2	0	
Cellular soil confinement		2	0	0	0	3	1	0	0	2	0	2	1	2	Anchor on steep slopes
Wind barrier fencing		0	0	0	0	2	0	1	0	0	0	0	0	0	
Flexible waterproof membranes		0	0	0	0	0	0	0	3	0	0	0	0	0	
Vertical soil moisture barriers		0	0	0	0	0	0	0	3	0	0	0	0	0	
Geosynthetic clay liners		0	0	0	0	0	0	0	3	0	0	0	0	0	
Prefabricated subsurface drainage		1	0	1	0	1	1	0	3	2	0	0	0	2	
Pipe inlet sediment barriers		0	0	0	0	0	0	3	0	0	0	0	0	0	Clean regularly
Wattles and logs		0	0	0	0	2	1	2	0	0	1	1	0	0	Needs pinning

Key to Rating System
 0 – not designed for, and has no expected performance in this application
 1 – not specifically designed for, but can enhance performance of other measures in this application
 2 – generally designed for this application in conjunction with other applications, but performance is less able to deal with the range of conditions met by specific purpose materials
 3 – specifically designed to meet a full range of requirements for this application

For information on trade names and suppliers of these products, please phone the office of Australasian Chapter of the International Erosion Control Association on 1800 354 322 or (+61 2) 4677 0901.



APPENDIX E

E Settlement of Dispersed Fines

E1 The Problem

Dispersible soils are those where the clay and fine silt particles (<0.005 mm) disperse into a state of separation into extremely fine colloidal units when exposed to water. These particles can remain suspended in water essentially forever because of common electrical charges on the colloidal surfaces, causing them to repel each other and stay in suspension. Stormwater runoff from exposed dispersible soils typically contains high levels of suspended solids (>500-1,000 mg/L) and turbidity. The failure of dispersed clays to settle is commonly exacerbated by wind-generated turbulence within sediment retention basins.

Settlement of these suspended particles typically requires the application of a chemical agent, which neutralises the surface charges, allowing the particles to settle relatively quickly. This process occurs naturally in estuaries, where fresh water inflows are exposed to a saline environment. This Appendix provides guidance on how chemical agents can be used to reduce the levels of suspended solids and turbidity in stormwater captured by sediment retention basins to an acceptable level, prior to discharge to the environment.

Information about dispersibility in soils at each land disturbance site should be provided in the *SWMP* along with a statement about how it will be managed. For many areas in New South Wales, information on dispersibility can be taken from Tables at Appendix C, together with the 1:100 000 soil landscape mapping available from the Department of Infrastructure Planning and Natural Resources. Information on techniques for managing the dispersible fines is given below.

E2 A Quick Field Test

Where sites might have dispersible soils and confirmation is necessary, a simple procedure that can eliminate the need for laboratory analysis is the “field” Emerson test, a test based on the Emerson Aggregate Test (Emerson, 1967). Here, a sample of soil material is taken from the likely sediment source and worked up as a bolus.^[1]

1. A sample of soil is taken that can comfortably fit into the palm of the hand, but ensure first that hands are clean (particularly, free of grease or oil). Water is added very slowly and the sample kneaded until all structure is broken down and the ball of soil just fails to stick to the fingers (it might help to crush the soil structure first with a pestle and mortar and pass it through a 2 mm sieve to remove any gravel or coarser materials). More water or soil can be added to attain this condition that is called the “sticky point”, and approximates field capacity for that soil. Continue kneading and moistening until there are no further apparent changes in the soil ball, usually about two or three minutes. The soil ball so formed is called a “bolus”. Note: that some soils:
 - (i) feel sticky as soon as water is added, but lose the condition as the bolus is formed – or at least until sticky point is reached;
 - (ii) are far stickier than others; and are very much harder to knead than others, e.g. heavy clays.

Next, a 5 to 10-mm cube of the bolus material is placed gently in a clear glass container containing sufficient distilled water to cover it. It is left to stand undisturbed for about three minutes with any change in condition noted.

One of two results is likely:

- no change will occur
- the sample will slake and/or disperse.^[2]

If there is no change or the sample slakes, the sample is not dispersible and further laboratory testing should not be necessary. However, if any of the bolus disperses and goes into suspension (the water near the sample becomes milky), undertake laboratory testing to find out whether more than 10 percent of the soil material is dispersible. Note that the more material that goes into suspension, the more dispersible is that sample. Regular sediment trapping devices are ineffective with soils having more than 10 percent dispersible materials and require artificial methods to help in the settling process or enhance filtration.

E3 Management of Dispersible Fines

E3.1 The Process

Two broad processes can be considered to help reduce suspended solids loads where a significant proportion of these are dispersible fines: coagulation and flocculation. Coagulating agents destabilise colloidal suspensions by neutralising the surface charges allowing settlement; flocculating agents cause the colloidal particles to clump into larger units or “flocs” that can either settle in a reasonable time or be filtered.

Users of flocculating and coagulating agents should also be aware that soils can be dispersible because of either common positive or common negative charges on the colloid surfaces. Users of these agents can start from the premise that, in New South Wales, most colloid surfaces are negatively charged. However, this might not be the case at any particular site.

E3.2 Common Agents

Many agents exist, including gypsum, alum, ferric chloride, ferric sulfate, polyelectrolytes (long-chain natural and synthetic organic polymers) including polyacrylamides (PAMS) and common salt (sodium chloride) or brine. Gypsum, PAMS and alum have traditionally been applied to treat stormwater runoff in New South Wales.

2. Soils that disperse must be distinguished from those that slake. Aggregates of soils that slake break down in water, but do not go into suspension as do dispersible soils, i.e. the particles settle relatively quickly.

When choosing a settling agent, note that:

- (i) the trivalent aluminium (Al^{3+}) ion present in alum is 2,000 times more effective than the monovalent sodium (Na^+) ion present in salt; and
- (ii) the bivalent calcium (Ca^{2+}) ion present in gypsum is only 50 times more effective than sodium (Barnes, 1981).

As such, alum produces a much faster settling rate than gypsum (Goldrick, 1996).

E3.3 Application Rates

Except where discussed at Section E4, below, always apply proprietary settling agents following the manufacturer's instructions as a first premise. Despite this, all sediment basins should be analysed after the first two storm events to determine the actual settling agent application rate and the settling time required. This requirement is because most soils respond differently to any particular settling agent. Standard jar tests are the usual method, undertaken following procedures set by suitably qualified laboratories.

In some situations, preliminary testing of water samples in a laboratory before discharge might be necessary to prove that the suspended solid content is below recommended levels, e.g. where the receiving waters are particularly sensitive. Naturally, all measures and procedures should be mindful of statutory requirements not to pollute waters with sediment or the agent, or from any secondary effects. In these cases, sampling details should be clearly set out in the *SWMP*.

The final application rate should be sufficiently high to permit removal of suspended solids and discharge of treated waters within an acceptable time without polluting waters with the agent itself. A rough field test that approximates an acceptable suspended solids content of 50 milligrams per litre is to fill a clear plastic or glass 65 mm diameter soft drink bottle with the water and hold it up to the light. If seeing very clearly through the sample is not possible, it is probably above 50 milligrams per litre and needs further treatment. Note, though, that materials other than suspended solids can cause water to be discoloured and laboratory testing might be necessary anyway.

E3.4 Some Warnings

Care should be taken with the choice of an agent, its dosing rate and any special conditions to ensure that toxic situations are not created with consequent damage to the ecology – some flocculating agents can become toxic if these matters are not given due consideration. Some, such as alum, have resulted in extensive destruction to large tracts of ecosystems in the United States when not managed properly.

Many New South Wales waters are acidic ($\text{pH} < 7.0$) and some are quite so ($\text{pH} < 5.5$).^[3] The ionic form of aluminium, which is highly toxic, is likely to occur below about $\text{pH} 5.0$ and more likely to occur at even lower pH levels. With the use of aluminium-based settling agents, accurate measurement and treatment of water pH must be undertaken to ensure that values are above 5.5 always. Regular ongoing testing of the runoff water should be undertaken to ensure that the recent exposure of certain soils in the catchment area has not caused pH levels to drop to less than 5.5. Further, any residual concentrations of alum remaining in the supernatant before discharge should not exceed the ANZECC (2000) freshwater quality “trigger value” of 0.055 milligrams per litre for aluminium at pH levels above 6.5.^[4]

As for residual polyelectrolytes, ANZECC (2000) suggests that a program of field testing for them cannot be justified because they cannot be measured reliably. They do not bioaccumulate, are highly biodegradable, and do not persist in the environment. Furthermore, the guidelines state that trigger levels for polyelectrolytes have not been established yet. The Responsible Care® Guidelines for Use of Polyelectrolytes are a Code of Practice for their use. When these guidelines are followed, PACIA (1998) suggest that they have very low mammalian toxicities and, generally, are considered to be innocuous materials. Nevertheless, excessive dosing with polyelectrolytes has been shown to:

- result in the release of materials that can kill fish and other aquatic life, especially when in the cationic form
- reduce the effectiveness of the agent.

Care should therefore be exercised in the use of these chemicals in stormwater treatment.

Finally, it is important that an individual on site is charged with the responsibility of overseeing the operations and maintenance of any sediment settling systems. Detailed monitoring and maintenance records should be kept detailing rainfall on site, the

3. Soil pH is a measure of the acidity or alkalinity of a soil. It relates to the concentration of the hydrogen ions (H^+) in the soil solution measured on a negative logarithmic scale of 1 to 14. The concentrations of hydrogen ions are equal to the hydroxyl ions (OH^-) at $\text{pH} 7$, greater below $\text{pH} 7$ (acid) and fewer above (alkaline). In the urban environment, the importance of pH is usually confined to its effect on the availability of elements in the soil and, therefore, possible deficiencies and/or toxicities. Whether these elements are available to plants depends on their solubilities, being available only when in soluble forms. The “essential” plant nutrients are in their most soluble forms around $\text{pH} 6$ to 7 .

4. The precipitation reaction that takes place in sediment basins can rapidly reduce the concentrations of alum in the water. Research on the leaching characteristics of alum sludge suggests that the alum is tightly bound to the sediment under both oxidising and reducing conditions at pH ranges between 5 and 7 (Metcalf, 2001). Sufficiently acid water conditions to loosen these bonds are unlikely to occur naturally in New South Wales except near poorly managed acid sulfate soils. Furthermore, pH reduction is unlikely to be induced by the use of aluminium agents themselves. Where aluminium settling agents are used properly, the sediment containing the settling agent is not considered toxic as the aluminium is bound up with the soil particles. It is common practice for the accumulated sediment to be dried on site and incorporated into fills. It should not be placed in a manner where runoff from this material can enter surface water directly.

catchment area(s) being served by the settling system(s), the degree of stabilisation, the volumes of settling agents used, and any other relevant matters.

E4 Two Suggested Methodologies

Two possible approaches to flocculation of sediment-laden stormwater within sediment retention basins are described in the following sections. These approaches differ markedly, from the manual dosing of captured stormwater following the cessation of a storm event (i.e. batch treatment'), through to "real-time" dosing of stormwater during the storm event, typically using some automated dosing system. Manual dosing, such as the most common application of gypsum to sediment basins following storm events, is simple but time- and labour intensive, whereas an automated system is more complex in terms of design and installation, but less intensive in terms of ongoing operation (although still requiring periodic monitoring and maintenance). Consequently, this latter approach may be most suitable for long-term disturbances, where the set-up requirements are most warranted.

The following sections describe these two approaches to the flocculation of sediment basins, comprising the manual dosing of basins using gypsum, and the automated dosing of stormwater using polyaluminium chloride (PAC). Of course, other types of flocculants can be used with either of these approaches, and other methods of dosing may be used. In all cases, managers should ensure that chemical treatment of stormwater is undertaken in a way that ensures that no harmful residual levels of the chemical agent are discharged to the receiving environment while still ensuring the desired degree of settlement.

E4.1 Manual Dosing of Basins Using Gypsum

Gypsum (calcium sulfate) is a relatively insoluble settling agent. Consequently, spreading it very evenly over the entire pond surface is essential for proper treatment of sediment-laden water. Normally, gypsum should be applied at a rate of about 30 kilograms per 100 cubic metres of stored water.

Figure E1 shows a suggested method of gypsum application for larger ponds where spreading evenly by hand is impractical. Ideally, the drum shown in figure E1 should have about a 50 litre capacity and holes about 25-mm diameter drilled on a 150-mm grid so pond water can enter. Constant stirring is necessary with the resultant slurry picked up through the inlet to a pump and sprayed evenly over the pond surface. In some instances, much higher rates of application than 30 kilograms per 100 cubic metres are necessary to achieve an acceptable suspended solids concentration, typically less than 50 milligrams per litre. Rates of up to 100 kilograms have been known to be necessary. As discussed at Section E3.1, above, each pond should be analysed after the first two storm events to determine the actual settling agent application rate and the settling time required.

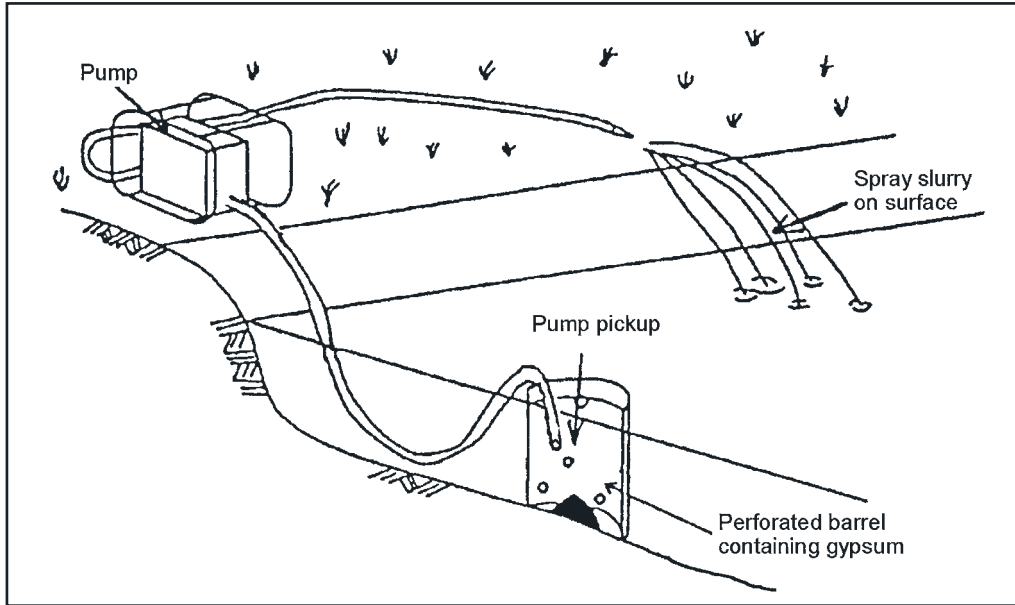


Figure E1. Application of gypsum



Figure E2. Poor gypsum application technique.

Spreading the gypsum evenly over the pond surface is essential. Figure E2 shows gypsum application where the slurry jet enters the water at too large an angle. In this instance, rates of up to 100 kilograms per 100 cubic metres of pond water were required to achieve the necessary water quality. Had the slurry jet entered the water at a much lower angle (e.g. at 10 or 20 degrees from the water surface), lower gypsum dosing rates could have been acceptable.

Assuming the pond is designed to the 5-day, γ -percentile depth (Section 6.3.4(c)), adequate settling is required in about four days from the conclusion of each storm event. This will allow one day to pump it out. The critical issue is to ensure the basin is pumped out and ready to receive more sediment-laden water within five days from the conclusion of a storm event. The water can be discharged from the basin once the suspended solid concentration has been lowered to the acceptable level. Treated basins should be dewatered with a system that:

- (i) ideally permits drainage of the pond in less than 24 hours ; and^[5]
- (ii) has a floating inlet to prevent settled sediments being removed as well – it is essential that materials from the sediment layer are not entrained and discharged in the dewatering process.

Of course, if the pond is designed to the 2, 10 or 20-day, γ -percentile depth, shorter or longer settling times apply, respectively.

E4.2. Automated Dosing of Stormwater Using Polyaluminium Chloride

The rainfall activated settling system outlined here is based on the use of polyaluminium chloride (PAC) and is adapted from TP90 Flocculation Guidelines prepared for Auckland Regional Council (Beca Carter Hollings & Ferner, 2003). Aluminium settling agents other than PAC, including alum (aluminium sulphate) might also be suitable for use in this system. Irrespective of which agent is used, the system should be designed following Section E3.3, above.

While not as simple in design and operation as the gypsum system described in Section E4.1, above, the PAC system avoids the need for regular pumping out of a sediment basin after rainfall. As such, it could be more suitable where sediment retention basins are designed for the 2-day, γ -percentile storm depth or for use at those times of the year when rainfall can occur more frequently than every five days.

(a) General System Details

The general components of the PAC sediment settlement system include a rainfall catchment tray, header tank, displacement tank and settling agent reservoir tank

5. Longer dewatering times are acceptable, so long as the full capacity of the settling zone is evacuated within the time period assumed in the design of the basin (e.g. five days from the completion of the storm event).

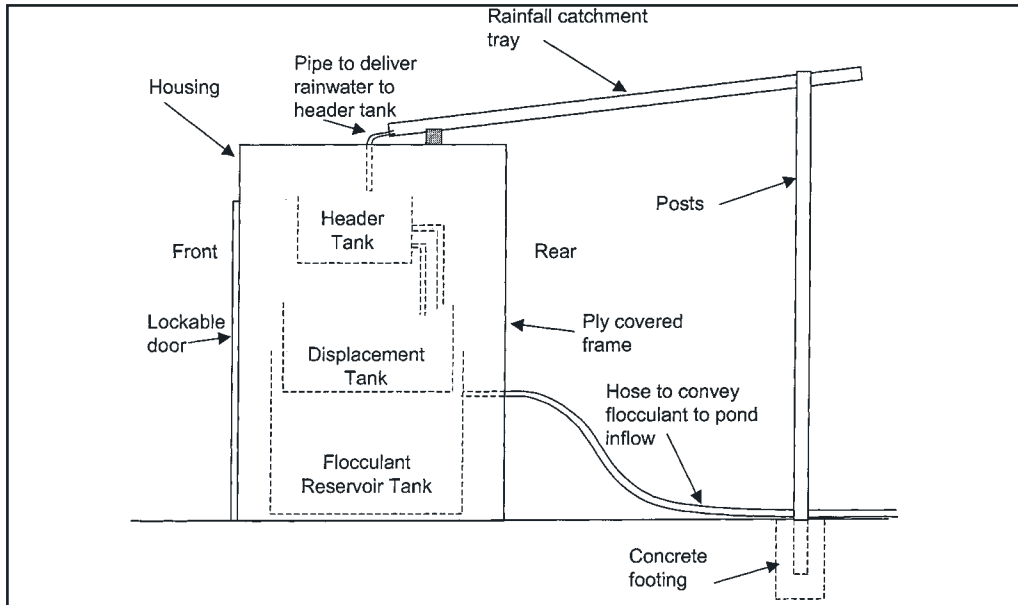


Figure E3. Sediment settlement system components (Beca Carter Hollings & Ferner, 2003).

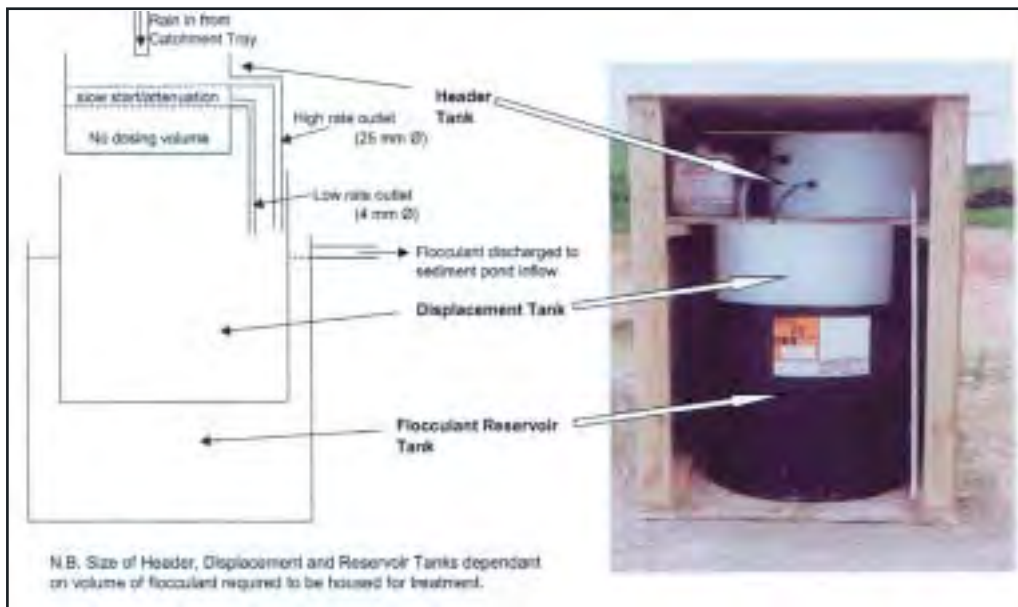


Figure E4. Sediment settlement system dosing details (Beca Carter Hollings & Ferner, 2003).

(figures E3 and E4). Apart from the catchment tray, these should be locked in a housing to discourage vandalism. Further, any settling agent storage area must be bunded to protect the site from spillages or leaks.

Rainfall from the catchment tray drains to a header tank. The header tank provides storage capacity to avoid dosing during initial rainfall following a dry period and attenuate dosing at the beginning and end of a rainfall event (to simulate the runoff hydrograph), i.e.:

- (i) zero settling agent discharge occurs until a preselected quantity of rain has fallen to allow for initial infiltration and saturation of dry ground before runoff commences;
- (ii) a slow start to the dosing rate occurs to allow for the response time of runoff flowing off the site at the beginning of a storm; and
- (iii) an extension of the dosing period beyond the rainfall period occurs to provide treatment of runoff following cessation of rainfall.

From the header tank, the rainwater discharges by gravity into a displacement tank that floats in the settling agent reservoir. As the displacement tank fills with rainwater, the settling agent is displaced through the outlet in the reservoir tank and flows by gravity to the dosing point. The dosing point should be selected in an area of high turbulence in the sediment basin inflow channel.

Important Note: For many soils in New South Wales, the required dose of aluminium is 8 milligrams per litre. One litre of liquid PAC typically contains 64.2 grams of aluminium (based on 10.1 percent of Al_2O_3 by weight). Therefore, 1 litre of PAC should treat 8,020 litres of stormwater at the above dosing rate. Nevertheless, when designing the rainfall tray, the settling agent supplier should be contacted to confirm the actual percentage of Al_2O_3 .

(b) Rainfall Catchment Tray

The size of the constructed catchment tray is determined by the size of the catchment draining to the sediment retention pond. Assume all the runoff from disturbed lands should be treated and 60 percent of the runoff from stable lands will require treatment at the design dose rate. The construction of the tray is set out in figure E5.

For the purposes of sizing the tray, a 50-mm storm event is considered. The runoff volume to be treated from 50-mm of rainfall is 500 cubic metres for a 1 hectare catchment. The volume of PAC required to treat 500 cubic metres is 62.3 litres. Given that the density of PAC is 1.2, 74.8 litres of rainwater needs to be collected to displace 62.3 litres of PAC. Further, a tray of 1.5 square metres is required to collect 74.8 litres of rainwater from a 50-mm event. Naturally, a larger tray would be required for a larger contributing catchment area.

Table E1 shows the tray surface areas required for different PAC dose rates.

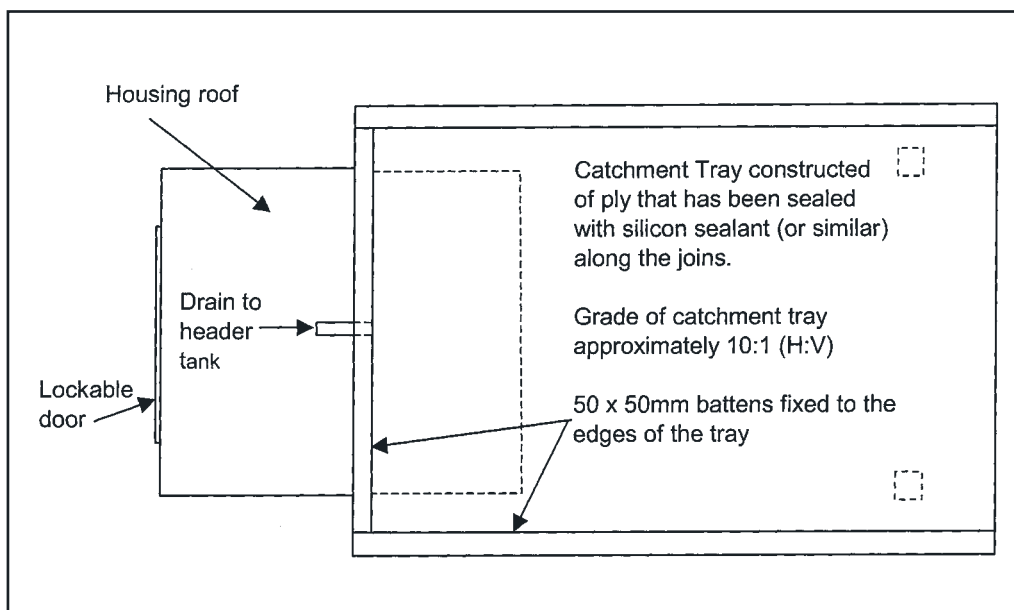


Figure E5. Construction of the catchment tray (Beca Carter Hollings & Ferner, 2003).

Table E1. Rainfall Catchment Tray Areas for Different Aluminium Dose Rates for a 50-mm Rainfall Depth

Aluminium dose required (mg/L)	Catchment tray area per hectare of catchment (m ²)
2	0.375
4	0.750
6	1.125
8	1.500
10	1.875
12	2.250

Assumptions: PAC has 10.1% Al₂O₃ by weight and the whole catchment is disturbed

(c) Header Tank

The zero (settling agent) discharge rainfall volume can be adjusted manually for site characteristics by adding or removing water from the header tank. Both low rate and high rate outlets should be installed:

- (i) The low rate outlet consists of a 4-mm internal diameter hose.
- (ii) The high rate outlet needs to have sufficient capacity to convey the maximum predicted flow from short-term rainfall, at least covering the 1 in 3 month storm event (unless otherwise stipulated by the local consent authority, this can be taken as half the 1 year, ARI time of concentration event. Generally, a pipe with an internal diameter of 25-mm should suffice, although systems treating large catchments might require larger pipes.
- (iii) The slow start/attenuation characteristics can be regulated for site characteristics by providing more than one low rate outlet and at different levels in the header tank.

The standard header tank design provides for up to 10 mm of rainfall before dosing commences. This requires provision of a delayed start volume below the low rate outlet of the header tank of 10 litres per square metre of rainfall catchment tray. So, for a 0.654 square metre catchment tray, the invert of the low rate outlet will be at the height reached by 6.5 L of water within the header tank. The high rate outlet invert should be positioned at that point reached by half the design storm depth. So, for a 0.654 square metre catchment tray, the invert of the high rate outlet will be at the height reached by 16.6 litres of water ($33.2/2$) within the header tank.

The header tank should have sufficient capacity to contain rainfall without over topping. A 50-mm freeboard above the top of the high rate outlet pipe provides this capacity.

(d) Displacement Tank

The displacement tank needs to be a neat fit inside the settling agent reservoir tank (figure E3). It should have sufficient capacity to provide for the dosing of at least the runoff from the whole of the 90th percentile 5-day rainfall depth from the tray.

(e) Settling Agent Reservoir Tank

The settling agent reservoir tank needs to be only slightly larger than the displacement tank. However, the larger the reservoir and displacement tanks are, the less servicing required. The settling agent reservoir tank requires sufficient capacity to provide for the dosing of at least the runoff from the whole of the 90th percentile 5-day rainfall depth from the tray. An outlet hose needs to be installed in the side of the tank to drain the settling agent to the pond inlet channel.

(f) Maintenance

The maintenance requirements of the PAC settling agent system need assessing following every rainfall event and during rainfall events if exceptionally heavy and/or prolonged rainfall occurs. Before staff leaves the site unattended for weekends, the sediment settling unit requires servicing by the responsible site staff member so that the maximum amount of runoff can be treated by the dosing system.

The following matters outline maintenance requirements for the PAC sediment settlement system. Note that the system will probably require some ongoing manipulation to suit the site characteristics and runoff:

Header Tank

- (i) The water level of the header tank is to be set to allow for certain rainfall before dosing starts. When the site is dry, it is estimated that up to 10-mm of rain might fall before significant runoff reaches the sediment retention basin. Therefore the header tank should remain empty in such conditions to allow for a delayed response.
- (ii) In wet weather or if the site is generally wet, water can be added manually to the header tank to cut down the response time so that dosing starts more rapidly after rain commences. If the system is to be operated at times of the year when precipitation normally exceeds evaporation (e.g. during winter in some parts of New South Wales), the system should also be set to no delay.
- (iii) Adjusting the water level within the header tank is to prevent under or overdosing of the pond. Under dosing can lead to higher levels of suspended sediment being discharged from the pond; conversely, overdosing can cause a reduction in water pH, in turn raising the potential for the aluminium within the PAC to react and forming toxic compounds that are bioavailable to fresh and marine water organisms.

Refilling with Settling Agent

- (i) When the volume of settling agent in the reservoir tank is reduced so much that insufficient time is available to dose a major storm, the displacement tank needs emptying and the reservoir refilled.
- (ii) The displacement tank can be emptied either by using a siphon or by being baled out by hand. The settling agent reservoir can be filled using a drum pump.

Monitoring and Adjustment for Changing Site Conditions

- (i) Each new settling agent treatment system needs to be monitored carefully during the first few rainfall events to check that the system is effective and to ensure that overdosing is not occurring (Section E3.3). Overdosing should be suspected if the pond dead storage water is exceptionally clear – samples must be taken

from the pond for pH and dissolved aluminium analysis. The dosing regime should be adjusted depending on the outcome of these results.

- (ii) If overdosing occurs or it is clear that the quality of stormwater runoff is improving because of stabilisation of the site, the settling agent dose must be reduced by reducing the size of the catchment tray. This can be done by placing and sealing a board (batten) diagonally across the tray with a hole through the tray rim at the lower corner, so that water from the tray area above the batten discharges to waste.
- (iii) The size of the rainfall catchment tray requires modification if earthworks alter the extent of the contributing catchment. Failure to do so will cause either under or over dosing of flows entering the sediment retention pond.
- (iv) Debris such as leaves should be removed from the catchment tray to ensure that rainwater continues to enter the header tank. The low and high rate hoses need to be checked regularly for blockages. All hose fittings should be inspected regularly to identify any leakages.



APPENDIX F

F Runoff Coefficients

F.1 Introduction

Two types of runoff coefficients can be used when applying the design criteria outlined in this manual:

- peak flow runoff coefficient
- volumetric runoff coefficient.

This Appendix discusses these coefficients and how they should be applied.

Accurately predicting the coefficient of runoff at construction sites is essential because the information is used in several key calculations, including the sizing of sediment basins and estimating peak flows in various flow conveyance structures . Here, coefficient of runoff relates to the ratio of catchment runoff to the rainfall in a nominated storm event (either in terms of rates or volumes) . It changes from site to site and from time to time in response to:

- catchment shape, size and slope
- drainage patterns
- surface condition, soil type and vegetative cover
- rainfall intensity.

The choice of a particular coefficient of runoff can greatly influence the design of soil and water management structures included in the treatment systems for a particular site. Also, it can be subjective. Accordingly, coefficients of runoff should always be recorded on the SWMP along with the assumptions and methods used in their estimation. The value of the coefficient is dependent on the soil hydrologic group and hydraulic factors.

F.2 Soil Hydrologic Group

Four Soil Hydrologic Groups (USDA, 1993) (Appendix C) are discussed below, derived from a consideration of their infiltration and permeability characteristics. The information in Tables F2 and F3, below, has been placed into these four Groups because of their likely effect on the generation of runoff. Vegetation is disregarded because it is usually stockpiled separately or, sometimes, removed from construction sites altogether. The four Groups are:

Group A – very low runoff potential. Water moves into and through these soil materials relatively quickly, when thoroughly wetted. Usually, they consist of deep (>1.0 metres), well-drained sandy loams, sands or gravels. They shed runoff only in extreme storm events.

Group B – low to moderate runoff potential. Water moves into and through these soil materials at a moderate rate when thoroughly wetted. Usually, they consist of moderately deep (>0.5 metres), well-drained soils with medium, loamy textures or clay loams with moderate structure. They shed runoff only infrequently.

Group C – moderate to high runoff potential. Water moves into and through these soil materials at slow to moderate rates when thoroughly wetted. Usually, they consist of soils that have:

- moderately fine (clay loam) to fine (clay) texture
- weak to moderate structure and/or
- a layer near the surface that impedes free downward movement of water.

They regularly shed runoff from moderate rainfall events.

Group D – very high runoff potential. Water moves into and through these soils very slowly when thoroughly wetted. Usually, they consist of soils:

- that are fine-textured (clay), poorly structured, surface-sealed or have high shrink/swell properties, and/or
- with a permanent high watertable, and/or
- with a layer near the surface that is nearly impervious.

They shed runoff from most rainfall events.

Most eastern Australian soils fall into Soil Hydrological Groups C and D. Notable exceptions include aeolian sands in some coastal locations and some alluvial soils. This is different from many soils elsewhere in the world that are more freely draining, often fitting into Groups A and B and being better suited to techniques that include grass swales, infiltration basins and porous pavements.

The best data for identifying the Soil Hydrologic Group are the field-derived subsoil parameters of texture, structure and colour (see “Soil Water Regime” in McDonald *et al.*, 1990). Two other factors can affect choice of the Soil Hydrological Group, namely depth of soil and data on profile water movement.

(a) Depth of Soil

Profile permeability can be limited by the presence of confining layers, e.g. hardpans, bedrock, high watertables, etc. In turn, these layers can influence the coefficient of runoff. Minimum acceptable depths to confining layers are shown in figure F1. Generally, the effect of any such layers can be ignored where depths are greater than these.

(b) Profile Water Movement

Where infiltration rates or saturated hydraulic conductivity (K_{sat}) data are available, these can be used to help estimate Soil Hydrologic Groups and runoff coefficients using the boundary values listed in Table F1. However, noting that such data are extremely variable and log-normally distributed is important and they should only be used as guides for improving Group estimates.

Important Note: Choosing more than one of the criteria in Section F3 and F4 in any particular subcatchment is reasonable. However, particular choices should be justified.

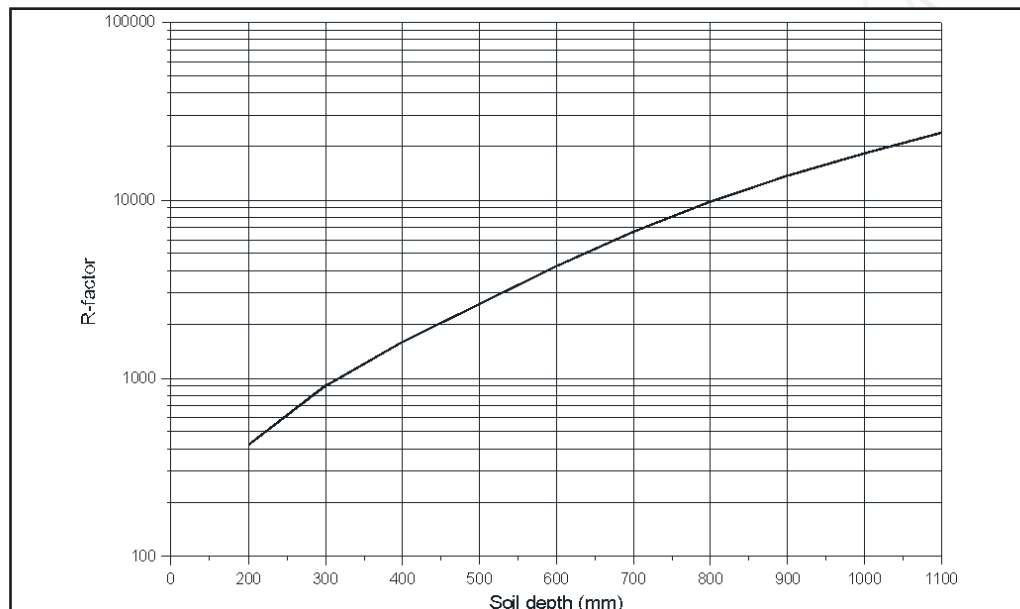


Figure F1 Minimum profile depth where confining layers can affect Soil Hydrologic Group

Table F1 Effect of K_{sat} and profile infiltration rates on Soil Hydrologic Group

Soil Hydrologic Group	Typical infiltration rate (mm/hr)		K_{sat} (mm/hr)	Rate of infiltration	Runoff potential
	Saturated steady state	Dry soil			
A	25	>250	>120	moderate to very rapid	very low
B	13	200	10-120	moderate to rapid ^[1]	low to moderate
C	6	125	1-10	slow to moderate ^[2]	moderate to high
D	3	75	<1	very slow ^[3]	high

1. Includes soils where the subsoil structure grade is moderate or strong or where the texture is coarser than silty clay.
2. Includes moderately permeable surface soils underlain by silty clays or silty clay loams with weak sub-angular or angular blocky structures; it includes permeable surface soils overlying massive clays or silty clays.
3. Includes soils where depth is limited by a hardpan, rock, high watertable, or other confining layer.

F.3 Volumetric Runoff Coefficient

Table F2 shows the recommended values for estimating runoff coefficients (C_v) for volumetric data in disturbed catchments and is used in the sizing of sediment basins on Type D and Type F soils. Generally, these structures are designed to contain all the runoff expected from a nominated rainfall depth or storm event.

Table F2. Runoff coefficients (C_v) for volumetric data in disturbed catchments (adapted from USDA, 1996)

Soil Hydrologic Group	Design Rainfall depth (mm)							Runoff potential
	<20	21-25	26-30	31-40	41-50	51-60	61-80	
A	0.01	0.05	0.08	0.15	0.22	0.28	0.37	very low
B	0.10	0.19	0.25	0.34	0.42	0.48	0.57	low to moderate
C	0.25	0.35	0.42	0.51	0.58	0.63	0.70	moderate to high
D	0.39	0.50	0.56	0.64	0.69	0.74	0.79	high

Little data exists in Australia in relation to volumetric runoff coefficients on disturbed lands. So, Table F2 has been determined using the United States Department of Agriculture's Curve Number Method (USDA, 1996).

Where the Soil Hydrologic Group is not known and/or cannot be found out without an additional soil survey (but see Appendix C), adopting a default volumetric runoff coefficient of 0.5 is reasonable. However, higher values should be considered for high-density development or other sites that can be subject to very high levels of surface sealing (e.g. wheel compaction). Alternatively, lower values can be adopted where a significant proportion of the site is to remain undisturbed (i.e. vegetated), if that value is properly justified. However, the correct Soil Hydrologic Group should be determined on all sites where design is to greater than the standard 85th percentile, x-day rainfall depth and/or where the receiving waters are deemed to be highly or extremely sensitive.

F.4 Peak Flow Runoff Coefficient

The peak flow runoff coefficient is used to convert rainfall intensity to a peak discharge in a nominated storm event. The peak discharge is used to:

- calculate settling zone capacities within Type C sediment basins
- design pipe outlets from sediment basins
- design spillways from sediment basins, wetlands and similar structures

- design waterways and swales.

Estimates of peak flow runoff coefficients can be made in three distinct areas:

- disturbed catchments (construction sites)
- natural or rural catchments
- urban catchments.

Disturbed Catchments

When areas become highly disturbed, e.g. for development of residential lands, the natural catchment relationships are temporarily affected before more formalised surface and drainage treatments are put in place. This is a critical phase when the potentials for runoff, erosion and sediment transport are constantly changing, but extremely high. During this period:

- construction sites are separated from the larger catchment
- vegetation is removed
- topsoil is stripped and stored on-site
- earthen building materials are imported and stockpiled
- soil surfaces are smoothed, cut, compacted and watered
- bare soil surfaces are reworked by heavy vehicles
- hard surfacing is increased.

Coefficients of runoff on disturbed catchments are also dominated by rainfall, but soil characteristics become much more important, principally the rate at which water can penetrate the soil surface and move through the soil profile. Knowledge of soil texture or grading, structure and soil depth become critical to estimating runoff, erosion and pollution potentials accurately. Vegetation is disregarded because it is usually stockpiled separately or, sometimes, removed from construction sites altogether.

Table F3 shows the recommended values for estimating runoff coefficients (C_{10}) for peak flow data in disturbed catchments. The table should be used only on disturbed lands where peak flow data are required, such as sizing of waterways, catch drains and sediment basins on Type C soils. In this table, soil materials have been placed into the four Soil Hydrologic Groups (Section F2, Appendix C) based on their likely effect on runoff.

Natural or Rural Catchments

Coefficients that relate rainfall to runoff from relatively natural forest or farm catchments are dominated by features like rainfall intensity, vegetation, slope gradient, soil type and rock outcrops. They are also affected by whether the area is ploughed or grazed, or have young, actively growing trees or older mature trees. Because these things are variable, difficult to measure and affect each other differently from time to time, runoff is estimated by adopting average figures based on gauged catchments. This is called the "Probabilistic Rational Method" of estimating catchment runoff. Further details are in Pilgrim (1998).

Table F3 Runoff coefficients (C_{10}) for peak flow data in disturbed catchments

Soil Hydrologic Group	Rainfall intensity (mm) in the design storm						Runoff potential
	<20	21-40	41-60	61-80	81-100	>100	
A	0.20	0.37	0.55	0.64	0.68	0.75	very low
B	0.46	0.58	0.70	0.75	0.78	0.82	low to moderate
C	0.69	0.76	0.83	0.85	0.86	0.88	moderate to high
D	0.80	0.86	0.89	0.90	0.90	0.90	high

Urbanised Catchments

Once catchments have been developed for urban purposes, their runoff characteristics also change. This is caused by the construction of roofs, roads, paved areas, driveways and the like. Hard engineering practices can dominate the relationships between rainfall and catchment runoff, more so than soils, vegetation, rock outcrops and rainfall intensity. Further details are in Pilgrim (1998).



APPENDIX G

G Rehabilitation Recommendations

This section presents information additional to that in Chapters 2 and 7 for application to lands where more than 1,000 square metres will be disturbed. It is not intended for application to construction of individual dwellings except in the unusual situation where *SWMP* is required because more than 2,500 square metres of land will be disturbed or because of a special request by the consent authority.

G.1 Site Assessment

Most projects benefit from a thorough assessment of the existing site conditions, including a soils and landscape analysis (Chapter 2). It should be undertaken before formulating a concept *ESCP* or *SWMP* (Chapter 3). The analysis should cover all relevant environmental factors, including physical and social factors, and be presented in a distilled form suitable for consideration in the site design process. Also, a cost benefit analysis study in the feasibility stage should identify the full order of likely costs. These analyses aid in establishing the theme for the initial soil and water management stabilisation techniques and for the final landscape development program. They include a full account of any future ongoing maintenance costs and likely adverse environmental effects from the use of any introduced species.

Where retention or rehabilitation of natural bushland or native grassland is proposed, it is essential that an initial assessment of the existing vegetation be carried out. Following interpretation of this assessment, any constraints to development should be recognised by all parties involved in the project. Many projects exist where the initial vegetation assessment (including trees) has not been carried out by a specialist and expensive measures have been adopted, only to discover subsequently that some plants:

- are diseased
- have structural defects
- are of an undesirable type, even noxious.

Such vegetation might have to be removed later, probably at much greater expense than otherwise would be the case.

On larger scale projects where a *SWMP* is required, the findings of the site assessment should be documented in a report and/or be illustrated in schematic or detailed drawings. On smaller projects, all aspects can be covered on a single landscape assessment plan. A strategy should be devised with relevant factors included in the plan, including a statement of design principles. These considerations should then follow into:

- the landscape design and documentation prepared by a landscape architect
- project documentation prepared by other members of the project team.

Because of the diverse nature of development programs, it is desirable that specialists,

who have expertise in landscape architecture, soil science and horticulture, are included in the project team. This is particularly important where retention or rehabilitation of natural bushland or native grassland is required or where new plantings consisting of woody species are proposed or required as a condition of local council consent.

To gain the most benefit for the project, the landscape architect is best appointed at the initial concept design stage of the project. Such persons should possess a thorough practical knowledge of horticulture and plant materials (soft landscape work requirements) suitable for the specific site conditions. They may wish to have access to Soil Scientists or other specialist professionals with a good practical understanding of soils. Currently, most landscape architectural practices:

- (i) employ a horticulturalist as a member of their team; and
- (ii) on particularly sensitive sites, might recommend the engagement of a botanist or other specialist to advise on specialist matters such as identification and recording of:
 - indigenous plant communities and their relationships
 - archaeologically and geologically significant features, etc.

To find a relevant landscape architect, landscape designer, horticultural consultant, soil scientist, soil conservationist, catchment adviser, or other specialists for selection on the project team, seek advice from your project manager or contact:

The Australian Institute of Landscape Architects (AILA) – contact the National Office Executive Officer, PO Box 1646, Canberra, ACT 2601.

Australian Institute of Horticulture Inc. (AIH) – contact the National Office Administrator, 15 Bowen Crescent, West Gosford, NSW 2250.

The Australian Institute of Landscape Designers & Managers Ltd. (AILD&M) – contact the National Secretary, PO Box 199 Oatley, NSW 2223.

The Australian Society of Soil Science Inc. (ASSSI) – contact the Executive Officer, PO Box 525, Mornington, Victoria 3931.

The Australasian Chapter of the International Erosion Control Association (IECA (Australasia)) – contact the Secretary, PO Box 33 Picton, NSW 2571.

Catchment Adviser, refer Catchment Advisory Manager/Officer of Department of Infrastructure, Planning and Natural Resources.

These people can assess the landscape, soils and horticultural potential of the site and recognise if:

- unfavourable site conditions exist or are proposed
- additional expertise is required in respect of special conditions.

They can make recommendations on how best to retain, modify, remediate or build in the facilities and growth conditions necessary to maintain or achieve successful growth conditions for ongoing soil and water management and future landscaping programs for

the site.

For other useful people, mainly concerned during documentation, tender and construction phases, contact:

National Arborists Association of Australia (NAAA) at PO Box 1184, Dee Why, NSW 2099.

Landscape Contractors Association of NSW Ltd (LCA) at PO Box 1226, Bankstown, NSW 2200.

Irrigation Association of Australia Ltd (IAA) at PO Box 301, Homebush, NSW 2140.

G.2 Species Selection

Grasses

Grassing in its many forms can serve well as a finished surface treatment and equally can provide useful temporary soil stabilisation as an interim measure. Later, it can be readily modified to allow for the full landscaping program.

Most grasses that are acceptable, in an urban context and from a fire hazard management point of view, require the ongoing expense of periodic mowing. On lands where this does not occur, invasions by natural undesirable weed growth including woody species such as lantana, Crofton weed, bitou bush, privet, etc. may occur. In many circumstances the lands also attract a build up of debris from stormwater or wind blown sources.

For information on selection of appropriate grass species to use on broad scale revegetation projects consult:

- your local office of the Department of Land and Water Conservation.
- your local landscape architect who has experience with revegetation work
- an experienced revegetation contractor.

For other sources of information on grasses in urban areas refer to:

- NSW Department of Housing publication Guidelines for Grass Selection in New South Wales (1993).

Woody Species

While quite a wide range of rehabilitation recommendations is covered elsewhere in this manual (Chapter 7), many of these have concentrated on grasses as the main type of plant material to be used for rehabilitation. Grassing generally is simple to install, has a low relative cost for the initial installation and is effective at soil stabilisation in the right situation.

However, it should be recognised that there are situations where grassing is not effective, for example:

-
- heavily shaded areas
 - extremely steep sloping areas with gradients steeper than 2(V):1(H)
 - services corridors and access pathways through natural bushland or native grassland areas
 - constructed landscape areas previously developed as self care mass planting or wooded areas
 - natural scenic areas where intrusion by introducing grass is inappropriate, including sensitive wetland or native fauna habitat areas
 - areas that suffer from prolonged periods of inundation by stormwater or saline water
 - hardpan, heavily compacted soils and areas subject to dryland salinity, etc.

For information on selection of appropriate plant species to use on revegetation projects consult:

- your local landscape architect who has experience with revegetation work
- your local horticulturalist that has experience with revegetation work.

For other sources of information on grassing in urban areas, refer to the NSW Department of Housing publications Guidelines for Plant Selection in New South Wales with separate volumes for each of five climatic zones as follows:

- Vol. 1 North Coast Climatic Zone (1993)
- Vol. 2 Central and South Coast Climatic Zone (1993)
- Vol. 3 Highlands Climatic Zone (1994)
- Vol. 4 Western Slopes Climatic Zone (1994)
- Vol. 5 Western and Far Western Plains Climatic Zone (1994).

G.3 Fertilisers and Ameliorants

To maximise success on revegetation works, it is essential that the correct soil and growth conditions be provided. A key component here involves the proper selection and application of fertilisers and soil ameliorants. Most soil types in New South Wales require the application of fertilisers and soil ameliorants.

Each site requires specific assessment to find out the most suitable and cost-effective fertiliser and soil ameliorants to be used. This assessment can be carried out by a suitably experienced horticulturalist or landscape architect, providing they have access to reliable soils information including interpretive comments. However, further specialist advice might be necessary from a catchment adviser on larger sites.

Where soils are found to warrant closer examination because of contamination, likely nutrient deficiencies, etc., having soil samples properly collected and analysed is necessary (Section 3.2). The work should be undertaken by a person with suitable

1. Agencies are currently discussing the concept that only certified people will be able to prepare Plans after 1 January 2004.

experience in soil science. Here, suitably experienced people include those certified^[1] by the Australian Society of Soil Science. This level of testing and interpretation differs somewhat from civil and structural engineering ground testing used for structural applications. When it comes to detailed analysis of soils for horticultural purposes, suitable specialist advice is offered through various state and Federal Government agencies and/or private consultants.

Most major fertiliser manufacturers can provide soil testing and advisory services on matters relating to the field in which their products occur.

Fertiliser Selection

For successful plant growth to occur it is essential not only to select and use the right plant species for the location, but also to ensure that the right balance of essential elements needed is present in the soil to initiate and sustain growth. In selecting any fertiliser or soil ameliorant, there are many factors that have to be taken into account and these are outside the scope of this publication. Refer Handreck and Black (1994) for in-depth advice on:

- growing media
- soils and the physical and chemical relationships needed for plant growth
- the environmental effects of misuse of fertilisers and associated products.

There are wide ranges of fertiliser and soil ameliorant products available to help with successful planting and ongoing maintenance of grassed and planted areas. Generally, fertilisers should be applied at the manufacturer's recommended rates at least once or twice per annum and additionally as required.

Fertilisers are generally available as bagged materials. However, for broad scale use, some can be obtained in a loose bulk form that can provide considerable cost saving over bagged products. All fertilisers, whether of bagged or bulk products, must be stored in dry locations. Stored fertilisers that have become wet or damp may lose their active constituents to the air and/or will become lumpy and unsuitable for spreading and use.

Fertilisers are prepared with a balance of nutrient elements suitable for the requirements of particular plants. The major elements needed in the greatest quantity are nitrogen (N), phosphorous (P) and potassium (K). Sulfur (S) is also required in lesser amounts for plant growth as are several trace elements but, generally, these are present in sufficient quantities in most soils. By law, manufacturers must provide the necessary chemical analysis of the major elements of N, P and K in their product. This analysis is known as the N:P:K ratio.

There are four main groups of fertilisers:

Inorganic Fertilisers – are manufactured, inorganic products specifically produced as lower cost plant fertilisers or being derived from the by-products of industry. They are described as “specific”, “general” or “complete” fertilisers depending on their chemical

constituent(s) and N:P:K ratio. With bulk inorganic fertiliser products, any cost saving derived from the materials handling point of view, where the product is stored on the ground, is offset by the adverse environmental effects left remaining by excess chemical residues in any temporary stockpile areas. There is also the potential for major hazardous leachate on adjoining lands.

Slow Release Chemical Fertilisers – are a refinement on the inorganic-based materials, but:

- to which an external coating has been applied
- release the active constituents into the surrounding soil at slower rates depending on the soil temperature.

Generally slow-release chemical fertilisers are more expensive than the other fertiliser types and are not typically used in grassing work because of cost. However, they are used commonly for revegetation with container grown plants.

Organic Fertilisers – come from a range of natural organic matter or from recycled and composted organic wastes that are naturally rich in the essential elements for plant growth. Typically, they can also consist of one or more of the following materials:

- raw, processed or composted abattoir waste byproducts
- fish and/or seaweed extracts
- processed sewage sludge.

There is a range of other potential organic-based materials that could be composted. However, these products are not acceptable on health grounds, being wastes generated from food production, animal fats and hospital wastes or with other materials that could be derived from wastes. These include hazardous chemicals, e.g. printer's ink, harmful dyes, and the like. Usually, they contain only low levels of nutrients. Any organic wastes used with processed sewage sludge should be composted and processed according to current public health and safety standards set by EPA (1997c).

Because of the nature of the essential elements for plant growth contained in organic fertilisers, the application rates of these types of fertilisers are usually required at much heavier rates than inorganic materials. Often this means that organic-based fertilisers are more expensive than other fertilisers. However, they are far more beneficial to plants and can sustain much healthier plant growth. They help build up the soil structure, tend to release nutrients slowly, and minimise nutrient pollution that otherwise can occur through leaching.

Stockpile waste from organic-based products generally can be more easily cleaned away and due to their nature and typically do not present any adverse long-term effects to the stockpile area and surrounding soil or the local environment.

Blended Inorganic and Organic and Other Fertiliser Products. A wide range of blended products are available that are combinations of the inorganic and organic-based materials and are satisfactory for use in a wide range of circumstances. Tables G1, G2, G3 and G4 suggest some starter and follow-up fertiliser options for grasses and individual plants.

Table G1 Starter fertiliser options for grasses

Fertiliser type	Product	Typical contents				Application rate (kg/100m ²)
		N	P	K	S	
Inorganic complete fertiliser	a	9.1	3.9	4.9	17.5	TBS
	b	9.1	4	4.9	17	TBS
	c	10.4	13.9	8.6	5.6	TBS
Organic-based complete fertiliser	a	7	5.1	5	11.7	TBS
	b	6.6	4.1	5.2	11.8	TBS
	c	3	2.5	1.6	1	TBS
Slow-release inorganic fertiliser	a	25	1	8	0	TBS
	b 15	14	4	0	TBS	

TBS = to be specified to suit specific plant size used and/or soil type.

Table G2 Follow-up fertiliser options for grasses

Fertiliser type	Product	Typical contents				Application rate (kg/100m ²)
		N	P	K	S	
Inorganic complete fertiliser	a	9.1	3.9	4.9	17.5	TBS
	b	9.1	4	4.9	17	TBS
	b	17.4	3.6	21.5	3.9	TBS
Slow-release organic fertiliser	a	13	0.5	0	0	TBS
	b	4.6	4.5	5	2.8	TBS
	c	5.4	5.3	0.1	0.1	TBS
	d	3	2.5	1.6	1	TBS
Slow-release pellets	a	16	4.4	8.3	0	Varies
	b	varies	varies	varies	varies	Varies

TBS = to be specified to suit specific plant size used and/or soil type.

Table G3 Fertiliser requirements for individual plants, on a plant-by-plant basis

Fertiliser type	Product	Typical contents				Application rate (kg/100m ²)
		N	P	K	S	
Slow-release pellets	a	20	0	18.8	0	TBS
	b	18	2.6	10	0	TBS
Prolonged-release tablets	a	20	4.3	4.1	1.6	TBS
	b	20	4.3	4.1	1.6	TBS
	c	12	2.6	5	0	TBS

TBS = to be specified to suit specific plant size used and soil type.

Table G4 Fertiliser requirements for individual plants, general surface dressing

Fertiliser type	Product	Typical contents				Application rate (kg/100m ²)
		N	P	K	S	
Blended organic-based	a	6.9	5.2	5.0	11.4	TBS
Organic	a	5.4	5.3	0.1	0.1	TBS
	b	4.6	2.3	3.4	0.0	TBS
	c	4.0	3.1	1.0	0.0	TBS

TBS = to be specified to suit specific plant size used and soil type.

Soil Ameliorant Selection

The need for an ameliorant mostly arises because of factors such as:

- over compaction
- little or no organic matter present
- too acidic (pH less than 5.0)
- high alkalinity levels (pH above 8.0).

These factors can be apparent through poor soil structure and poor plant growth, especially weed growth on soils known to be free of harmful contamination.

Soil ameliorants include:

- gypsum, to alter the chemical structure and thus aeration and permeability of certain problem clay soils by causing clumping of the clay particles and to lessen soil salinity in some soils
- lime, to "sweeten" or render the soil less acid
- sulfur, to make soils more acid
- composts or other suitable organic materials complying with A.S.4454-1997 "Composts, Soil Conditions and Matches", e.g.:
 - spent mushroom compost
 - composted organic tip waste
 - blended proprietary organic products (includes most of the composted materials)
 - composted pine bark and sawdust (suitable for horticultural application)
 - composted bulk animal manures (e.g. composted feed lot cow manure)
 - composted sugar cane tops
 - composted sewage sludge with a biosolid's classification "Unrestricted Use" according to EPA (1997c).
- coarse, clean or washed sands.

Also, there are many other specialist chemical and water retaining products that can be considered and that might be raised by the specialist adviser during the site assessment stage. They should be thoroughly mixed into the soil by such means as deep cultivation or rotary hoeing. Materials should be free from extraneous matter, salt, persistent weed growth, and substances deleterious to plant growth.



APPENDIX H

H Vegetation Management Plan

(Provided by officers of the Department of Infrastructure Planning and Natural Resources)

1. **Assess the site and determine the constraints:** flora and fauna (previous studies, endangered species, ecological communities and existing vegetation communities, etc.); habitat and corridor values; topsoil/litter layer quality; hydrology/hydraulics (flooding, surface water runoff/drainage, velocities, watertables, etc.); frost areas; fire issues; contaminants; acid sulfate soils; salinity; roads and pathways; railways; airfields; service infrastructure (water, sewerage, gas, electricity, communications); archaeological and heritage; stock and herbivore access (rabbits, hares, ducks, etc.); shadow zones; drainage; topography (slope, aspect, soils, geology, erosion, deposition); weeds and weed sources; risk of vandalism; public safety issues; etc.
2. **Define the project tasks:** describe each task necessary for the implementation of the plan, how each task will be done, the duration of each task, the priority order for each task and who will be responsible for undertaking each task.
3. **Prepare a schedule (e.g. Gant Chart):** address all tasks in the project.
4. **Liase:** contact council Bushcare Officer, Landcare or Bushcare groups for advice.
5. **Provide details on seed collection and propagation:** local native species only to be used – identify local native seed sources, check on any licences required – identify who will propagate.
6. **Prepare maps/diagrams and plant species lists:** describe existing vegetation, constraints, vegetation and natural features to be retained, proposed vegetation (species/communities, zonation from water to land, corridors/linkages, spacings, tube stock/Virocells/long stems/direct seeding, etc.), sediment and erosion control, stabilisation works, etc.
7. **Provide details on site preparation:**
 - protection of plants to be retained
 - installation of sediment and erosion control devices
 - completion of any site works (if any)
 - weed control (techniques and sequences of removal)
 - application of herbicides
 - topsoil/litter layer storage
 - soil remediation
 - surface preparation (levelling, deep ripping, scarifying, mulching etc.)
 - surface stabilisation – (needs to be suitable for the site/vegetation – erosion matting, mulch, brush matting, sterile cover crops, binding sprays, etc.)
 - site drainage

-
8. **Describe the planting program and method:** detail how it will be done, staging and consider the installation of weed mats, mulch, stakes & ties, tree guards and the use of fertilizer types (justify their need), water-retaining crystals, etc.
 9. **Describe site and vegetation maintenance:** sediment and erosion control, watering, replacement of plant losses, weed control, disease and insect control, mulch, etc. (Note: DIPNR requires a minimum of two years maintenance after last plantings completed).
 10. **Describe the monitoring and review process:** include a method of performance evaluation, assessing the need for replacing plant losses, addressing deficiencies and six-monthly reporting.
 11. **Address other issues:** signage, relevant legislation, planning instruments/guidelines, OH&S, community involvement, liaison with DIPNR and others, how other parts of the site and adjacent areas can be managed to compliment the vegetation strategy (weed control, drainage, etc.), etc.
 12. **Prepare a costing:** for the implementation of all stages and all components of the work – show details on unit cost, materials, labour, monitoring/maintenance/reporting, etc.



APPENDIX I

I Management of Waterfront Land

(Provided by officers of the Department of Infrastructure Planning and Natural Resources)

I.1 Introduction

By late 2003, the Water Management Act 2000 (WMA) will have repealed the Rivers and Foreshores Improvement Act, 1948 (RFIA). When this occurs, activities that required Part 3A Approvals under the RFIA will require Controlled Activity Approvals under the WMA. The approval processes will be similar; however the emphasis of Controlled Activities Approvals under the WMA will be:

- to protect and restore water sources
- to ensure minimal harm because of development.

Therefore, a more rigorous assessment process will be implemented for some forms of development.

The Department of Infrastructure Planning and Natural Resources (DIPNR) is developing policies and procedures dealing with the management of development on waterfront (riparian) land. These policies and procedures have not been finalised yet. This Appendix offers insight to those being developed by the DIPNR Resources at the time of publication.

I.2 Principles Governing the Management of Controlled Activities

An emphasis of the WMA is that it focuses more closely on environmental protection and restoration of waterfront land. S. 9 of the Act states that it is the duty of all persons exercising functions under the Act to do so according to the Water Management Principles and to give effect to the State Water Management Outcomes Plan. Specifically, therefore, waterfront land will be managed as follows:

- (a) The Objects (s. 3) and Water Management Principles (s. 5) set out in the WMA. It is important to note that the Objects and Principles of the WMA require measures to protect and enhance the social, economic, cultural, spiritual and heritage values of waterfront land for Aboriginal groups and the wider community, and more specifically in relation to controlled activities on waterfront land:
 - (i) the carrying out of controlled activities must avoid or minimise land degradation, including soil erosion, compaction, geomorphic instability, contamination, acidity, waterlogging, decline of native vegetation or, where appropriate, salinity and, where possible, land must be rehabilitated; and

-
- (ii) the impacts of the carrying out of controlled activities on other water users must be avoided or minimised.
- (b) The objects and targets of the State Water Management Outcomes Plan (SWMOP). Specifically relevant to development on waterfront land are Targets 28, 29, 30 and 31 of the SWMOP:
- (i) Target 28: Percentage cover of native riparian vegetation within waterfront land increased consistent with an approved catchment management plan or by at least 5 percent where it is currently less than 50 percent of the natural average on 3rd order and larger rivers.
 - (ii) Target 29: No net decrease in the length of natural river corridors through urban areas.
 - (iii) Target 30: Coastal floodplain areas with high water quality risk (e.g. acid drainage and/or oxygen depletion) addressed by:
 - 30a: Areas of drained natural wetlands identified and mapped
 - 30b: Seven pilot remediation projects completed
 - 30c: Future program of land rehabilitation developed and commenced
 - 30d: No increase in acid drainage resulting from any development in a mapped acid sulfate soil hotspot.
 - (iv) Target 31: The peak volumes of urban stormwater runoff reaching natural watercourses reduced.
- (c) Legislation including the National Parks and Wildlife Act, Fisheries Management Act; and policies including Riverine Corridor Policy and management guidelines (both still under development), NSW Wetlands policy, NSW, Estuaries Policy and NSW Coastal Policy.

1.3 Indigenous Considerations

Aboriginal peoples' understanding of waterways is far more broad and multi dimensional than is allowed for in modern land title practices and topographic maps. Waterways and associated tracks and areas are a vital part of "Dreaming Knowledge" and associated cultural and spiritual practices. Cultural memory and "Dreaming Knowledge" embrace areas beyond the mapped confines of waterways including areas watered in "super-floods" that occur only every thousand or many thousands of years. Past and current practices, "Dreaming Knowledge" and contemporary values underpin a dynamic and developing relationship of Aboriginal groups with waterways that are very much alive today.

The WMA requires Controlled Activity policies to (among other matters) "recognise and foster the significant social and economic benefits to the State that result from the

sustainable and efficient use of water, including benefits to the Aboriginal people in relation to their spiritual, social, customary and economic use of land and water". This requires planning, management and impact assessment policies that recognise and encourage:

- (i) past and continuing associations with waterways as noted above, including as appropriate preservation of sites of cultural significance (site preservation is just one of several strategies for developing these associations);
- (ii) current and emerging social and economic benefits to different Aboriginal groups; and
- (iii) a high level of effective involvement of local Aboriginal groups in decision making processes so that the varied values and benefits in particular geographical areas can be identified and improved.

1.4 New Definitions

Controlled Activity is defined in the WMA as:

- (a) the erection of a building or the carrying out of a work (within the meaning of the Environmental Planning and Assessment Act 1979), or
- (b) the removal of material (whether or not extractive material) or vegetation from land, whether by way of excavation or otherwise, or
- (c) the deposition of material (whether or not extractive material) on land, whether by way of landfill operations or otherwise, or
- (d) the carrying out of any other activity that affects the quantity or flow of water in a water source.

The controlled activity provisions of the WMA replace and expand on the requirement for a permit to undertake activities on land next to protected waters under the (RFIA). The definitions relevant to waterfront land in the WMA have been amended.

Provisions as Amended (*new words in italics*):

- (i) *estuary* means:
 - (a) *any part of a river whose level is periodically or intermittently affected by coastal tides, or*
 - (b) *any lake or other partially enclosed body of water that is periodically or intermittently open to the sea, or*
 - (c) *anything declared by the regulations to be an estuary, but does not include anything declared by the regulations not to be an estuary.*
- (ii) *waterfront land* means:
 - (a) *the bed of any river, together with any land lying between the bed of the*

river and a line drawn parallel to, and the prescribed distance inland of, the highest bank of the river, or

- *(a1) the bed of any lake, together with any land lying between the bed of the lake and a line drawn parallel to, and the prescribed distance inland of, the shore of the lake, or*
- *(a2) the bed of any estuary, together with any land lying between the bed of the estuary and a line drawn parallel to, and the prescribed distance inland of, the mean high water mark of the estuary, and*
- *(b) if the regulations so provide, the bed of the coastal waters of the State, and any land lying between the shoreline of the coastal waters and a line drawn parallel to, and the prescribed distance inland of, the mean high water mark of the coastal waters, where the prescribed distance is 40 metres or (if the regulations prescribe a lesser distance, either generally or in relation to a particular location or class of locations) that lesser distance.*

Land that falls into two or more of the categories referred to in paragraphs (a), (a1) and (a2) can be waterfront land by virtue of any of the paragraphs relevant to that land.

(iii) *lake* includes:

- (a) a wetland, a lagoon, a saltmarsh and any collection of still water, whether perennial or intermittent and whether natural or artificial, and
- (b) any water declared by the regulations to be a lake, *whether or not it also forms part of a river or estuary*, but does not include any water declared by the regulations not to be a lake.

(iv) *river* includes:

- (a) any watercourse, whether perennial or intermittent and whether comprising a natural channel or a natural channel artificially improved, and
- (b) any tributary, branch or other watercourse into or from which a watercourse referred to in paragraph (a) flows, and
- (c) anything declared by the regulations to be a river, *whether or not it also forms part of a lake or estuary*, but does not include anything declared by the regulations not to be a river.

NOTE: For the purposes of Controlled Activity Approvals (and exemptions to approvals) it is proposed that the “blue line” on topographic maps be used to identify watercourses. Watercourses shown on topographic maps as broken blue lines are deemed continuous if they lose definition and then reappear. Watercourses that were previously blue lines and have now been moved are still deemed to be blue lines in the new location.

I.5 Controlled Activity Policies

The DIPNR is in the process of preparing a comprehensive policy paper that deals specifically with controlled activities/development on waterfront land. In addition, supplementary policy papers are being prepared that specifically deal with Controlled Activities in relation to:

- Greenfields urban development sites
- Urban consolidation
- Mining on or under waterfront land
- Public Authorities.

There is a recognised need to take a strategic approach to the implementation of the controlled activity provisions of the WMA. This is to minimise duplication and unnecessary restrictions, while recognising that integrating the implementation of the controlled activity provisions into the existing management framework initiatives is required. These provisions include a planning component (ss. 31, 32, 33, 34(a), (b) and (c)); however it is uncertain at this stage as to how controlled activity planning will be implemented. Most likely these provisions will be used to manage “hotspot” areas. There are also provisions that deal with approvals (s 91) and directions (ss. 326, 327).

As a result, managing controlled activities will be based on a multifaceted approach, including the following:

- (a) *Partnerships* – with the general community, Aboriginal groups, industry, local government and other State agencies. In particular, to develop mutual understandings and to encourage best management practise.
- (b) *Exemptions* – several exemptions from the requirement for a controlled activity approval are being proposed. These include:
 - activities on waterfront land near minor watercourses that are not identified on specified topographic maps
 - actions with a beneficial environmental outcome such as removal of noxious plants
 - minor ‘residential’ works in urban areas (such as the building of BBQs)
 - construction of works for domestic and stock water supply
 - the maintenance of existing structures (so long as there is no extension of the structure over the land)
 - regeneration of native vegetation
 - activities carried out following the NSW Farm Dams Policy.

There will be limits to these exemptions, for example there will be no exemptions in areas that are of high conservation value, or areas that are deemed to be environmentally sensitive, or areas that are at risk of acid sulphate soils, or for developments that require the removal of native vegetation.

It is proposed that these exemptions will be set in a Regulation that will go before Parliament in late 2003.

Under the RFIA, activities carried out under any lease, licence, permit or other right in force under any Act relating to mining or under the Crown Lands Act or Crown Lands (Continued Tenures) Act 1989 were exempt from the need to obtain a permit. These exemptions have not been carried over in the WMA due to the potential impact that these activities have on waterfront land, and to improve consistency with the management of activities on waterfront land. The RFIA also exempts the activities carried out by public or local authorities – another exemption that has not been carried over to the WMA. However, it is proposed to delay the removal of this latter exemption for one year from the commencement of the controlled activity provisions, as a transitional measure.

- (c) *Applications* – It is proposed that an integrated procedures and assessment process be implemented within the DIPNR to help developers with their applications. This process will advise applicants individually of their obligations under the Native Vegetation Conservation Act, the Water Management Act and the Plantations and Reafforestation Act. This process will aim to reward good practice and minimise cost and will provide maximum clarity about where approvals are needed and where they are not.
- (d) *Advertising* – The WMA provides for the regulations to specify those applications that are to be advertised and open to third party objections. It is proposed that the following will be advertised:
- sand and gravel extraction on a commercial scale
 - clearing of native vegetation over more than 50 metres along the edge of a water course
 - realignment of water courses (e.g. straightening, relocation)
 - activities on, in or under the bed or bank of fourth order, and above, rivers.

1.6 Controlled Activity Approval Application Process

Applications will be able to be lodged at the Departments regional offices, either in person or by mail. A form will need to be completed to make an application.

In the future, electronic lodgement of applications, for example, by a secure connection on the Department website, will be possible. However, this facility is not yet available. The proposed steps for the lodging of an application are as follows:

- 1. enquiry
- 2. pre-application meeting
- 3. user applies for approval
- 4. DIPNR assesses validity of application i.e. check of information supplied, embargoes, and payment of fees

- 5. application accepted - acceptance recorded in register
- 6. new application is posted on internet register of WMA applications
- 7. if application must be advertised, then it is advertised
- 8. Triage Basic assessment
- 9. full detailed assessment (if necessary)
- 10. third party objections assessed
- 11. evaluation
- 12. determination - application granted/refused, parties and any objectors notified, determination entered into register
- 13. determination information recorded on internet register.

1.7 Information Required with an Application

Applicants will be required to provide a completed application form, information required to support the application and pay any fees. Information required to be provided will include basic information, assessment information and, sometimes, further detailed information. The application form and an accompanying Applicant's Guidelines will advise applicants of details of what is required.

1.7.1 Basic information

Provision of some basic information will help the DIPNR to know the exact nature of the proposed activity, so that the application can be determined according to the legislation. The basic information will include:

- (i) the name and address of the applicant (full details required). This will help the Department identify and contact the proponent;
- (ii) the address, formal particulars of title, and location of the land on which the controlled activity is to be carried out. This will help the Department to locate the land on which the proposed activity is to be undertaken;
- (iii) information showing that the applicant has a legal right to enter the land and carry out the controlled activity. This will help the Department to determine whether the proponent has the right to enter the land and carry out the proposed activity. For example, if the proponent is not the owner, a statement signed by the owner of the land to the effect that the owner consents to the making of the application and the carrying out of the activity will be required;
- (iv) permission for Department staff to enter the land to carry out inspections necessary to determine the application. This is a requirement to allow Department assessment staff to confirm information supplied with the application by inspecting the site, and to collect any additional information required to determine the application;

-
- (v) a site plan of the land and a description and plan of the proposed controlled activity, indicating the following:
- the location, boundary dimensions, site area and north point of the land
 - the location of the activity in relation to the land's boundaries, and rivers and lakes
 - the location of any proposed excavation or deposition of materials, and the existing and proposed finished levels of the land (where these are proposed to be altered)
 - existing vegetation on the land
 - proposed techniques used to carry out the controlled activity
 - proposed revegetation or rehabilitation of the land
 - the proposed timeframe for carrying out the components of the activity.

Applicants will need to provide assessment information on the impacts of the proposed activity on a range of environmental, social and economic criteria. This assessment information is required to enable the Department to confirm and evaluate impacts of the proposed activity, in particular the impacts on waterfront land, and to decide whether the application should be approved or refused. The Department will publish Applicants' Guidelines to help applicants to provide this information. These Guidelines will include different levels of comprehensiveness based on the impact of a proposal.

1.7.2 Information required for the assessment of an application will include:

- (a) A statement of impacts, addressing the following:
- (i) the impacts of the controlled activity on specified environmental, social and economic criteria (including, where necessary, impacts on cultural, spiritual and heritage values of Aboriginal and other community groups). The nature of the requirement for this is to be set out in the proposed environmental assessment guidelines. It is important to note, however, that it is important for relevant planning instruments to identify as far as possible potential impacts and required strategies for dealing with these impacts;
 - (ii) how the impacts of the controlled activity have been identified; and
 - (iii) the steps to be taken to minimise the impacts.
- (b) Where the proposed controlled activity does not require consent under Part 4 of the EP&A Act, the following information can be required to help the Department to undertake the assessment under Part 5 of the EP&A Act:
- (i) an 8-part test under s. 5A of the EP&A Act to assist in determining whether the controlled activity is likely to affect threatened species significantly, populations or ecological communities, or their habitats. If the activity will have a significant effect, then a species impact statement prepared following the Threatened Species Conservation Act, 1995 (TSC Act) will also be required;

- (ii) an assessment of the proposed activity that takes into account the factors listed in s. 228(2) or guidelines published by Planning NSW, and an Environmental Impact Statement (EIS) prepared according to the EP&A Act, if required;
- (iii) a statement on how the proposed activity compares with best management practices or industry standards, and a management program for the land to which the application relates.

1.7.3 Further detailed information required

Where an application might have major impacts on a criterion, or several criteria, required to be assessed, further detailed information can be required from the applicant, to enable the Department to undertake a proper evaluation and to make an appropriately-informed determination. This further detailed information will be specified in Applicants' Guidelines and specific advice from the Department to the applicant. The Department will endeavour to advise applicants of the detailed information that they are required to provide with their application as early as possible in the process (for example, at any pre-application meeting). However, as the assessment progresses, it might become apparent that further information is required, and the Department can seek this from the applicant at any stage in the assessment process.

1.7.4 Fees for applications

Fees will be charged, however at this stage the schedule of fees is undetermined

1.8 Determination of Applications

1.8.1 Assessment

Among other factors, the assessment can involve the following:

- (i) consideration of matters relevant to the application (s. 95(1) WMA) including:
 - the water management principles
 - the objects of the WMA
 - the State Water Management Outcomes Plan
 - any matters prescribed by the regulations (s. 96 WMA)
 - matters to be considered for possible inclusion in the regulations;
- (ii) environmental planning instruments (State Environmental Planning Policies, Regional Environment Plans and Local Environmental Plans);
- (iii) planning frameworks (Catchment Blueprints);
- (iv) Regional Vegetation Management Plans;
- (v) Relevant State policies: Riverine Corridor Policy and Riverine Corridor

Management Guidelines (when available), NSW Wetlands Management Policy and action plan, NSW Coastal Policy, Estuaries Management Policy;

(vi) any other matters included in the Departments guidelines for this purpose.

Policy will be developed that will give the Department and applicants clear guidance about the type of activities or impacts that are likely not to be approved. These will be included in guidelines for applicants along with an estimate of the likely time frame for decisions.

1.8.2 WMA can require multiple approvals

In some cases, the WMA can potentially require multiple approvals for the one activity. For example, construction of a water supply work can require both a work approval and a controlled activity approval, in theory. A mining activity with potential impacts on an aquifer can require both a controlled activity approval and an aquifer interference approval, in theory. In such cases, the enterprise should be able to obtain a single approval through a single, integrated application and assessment process. For example, if approval is sought for approval to construct one pump, then a water supply work approval will suffice for this purpose a controlled activity approval will not also be required. This principle is being built into the development of the Departments Integrated Environmental Assessment Guidelines, and will be made clear to an applicant as early as possible (e.g. a pre-application meeting).

1.8.3 Controlled Activity Approvals and the Native Vegetation Conservation Act.

As a general principle, clearing of native vegetation on protected land will not require both a controlled activity approval under the WMA and also clearing consent under the Native Vegetation Conservation Act 1997 (NVCA).

A proposed activity can involve more than clearing on waterfront land. For example, it can also involve excavation of land and/or construction of a building or other structure such as a jetty. In this circumstance, a controlled activity approval can be required (or other WMA approval) unless a WMA exemption applies.

1.8.4 Integrated development and other cases where authorisation under different statutes is required

Several instances exist where authorisation under the WMA and other statutes can be required for the one activity. These situations can involve integrated development. Integrated development is development that, in order for it to be carried out, requires development consent and a controlled activity approval (or other approval listed under section 91 of the EPA Act). The purpose of the integrated development provisions of the

EPA Act is to streamline development approval where there were a number of approval bodies, including the Department. This process will not change from the process for integrated development currently in place for the RFA. The Department will continue to be fully involved in the Integrated Development Assessment Scheme.

There are many examples where multiple authorisations can be required. In some cases, a mining activity might require authorisations under the Mineral Resources Act as well as the WMA. In some cases, authorisation under the National Parks and Wildlife Act can be required for activities that might affect Aboriginal sites of cultural or heritage significance.

1.8.5 Security deposits

For some applications, the lodgement of a security deposit can be a precondition to the granting of an approval. Security deposits will be used to improve compliance with conditions of approval, in particular where rehabilitation of the site is required, for example restoring levels or revegetation. Security deposits will be forfeited in response to non compliance with the conditions of consent requiring rehabilitation. The forfeited deposit will be used for rehabilitation of the site. Applicant guidelines will provide further information on procedures in relation to the use of security deposits. It is proposed that a security deposit will be in the form of a bank guarantee.

1.8.6 Register of applications and approvals

Under s. 113 of the WMA, the Department must keep register of applications and a register of approvals, including those granted, renewed, transferred, surrendered, suspended and cancelled. There is no intention to charge a fee for the registering of applications.

The public approval's register is to consist of two parts:

- (i) "internet component": – this will not include the following personal information – applicant's name, approval location, conditions, reasons for decision; and
- (ii) "non published component": this will include the full details of the approval including the personal information, approval conditions and reasons for decision omitted from (i). This component of the register can only be accessed through a written application to DIPNR.

The approval's register is to include the following information:

- (i) all types of approvals including:
 - water supply work
 - water use
 - flood work
 - drainage work

-
- controlled activity
 - aquifer interference approvals;
- (ii) all applications for new or renewed approvals;
- (iii) applications granted;
- (iv) all approval applications refused; and
- (v) approvals created at transition:
- water supply work and water use approvals converted in July 2003 for areas covered by WSPs
 - work and water use approvals converted over four years following July 2003 as new plans are made
 - flood work approvals commence conversion in mid 2004
 - drainage work approvals commence conversion in mid 2004
 - controlled activity approvals “deemed” conversion in November 2003 (note: RFA permits will not be physically converted to controlled activity approvals. Instead these permits will be legally deemed to be controlled activity approvals. These deemed controlled activity approvals are not to be recorded on the approvals register – this approach is adopted for practical reasons, i.e. the short term nature of these approvals).



APPENDIX J

J Worksheets

J.1 The Standard Worksheet

Note: These “Standard Calculation” spreadsheets relate only to low erosion hazard lands as identified in figure 4.6 where the designer chooses to not use the RUSLE to size sediment basins. The more “Detailed Calculation” spreadsheets should be used on high erosion hazard lands as identified by figure 4.6 or where the designer chooses to run the RUSLE in calculations.

1. Site Data Sheet

Site name: _____

Site location: _____

Precinct: _____

Description of site: _____

Site Area	Site						Remarks
Total catchment area (ha)							
Disturbed catchment area (ha)							

Soil analysis

Soil landscape							DIPNR mapping (if relevant)
Soil Texture Group							Sections 6.3.3(c), (d) and (e)

Rainfall data

Design rainfall depth (days)							See Sections 6.3.4 (d) and (e)
Design rainfall depth (percentile)							See Sections 6.3.4 (f) and (g)
x-day, y-percentile rainfall event							See Section 6.3.4 (h)
Rainfall intensity: 2-year, 6-hour storm							See IFD chart for the site
Rainfall erosivity (R-factor)							Automatic calculation from above data

Comments

2. Storm Flow Calculations

Peak flow is given by the Rational Formula:

$$Q_y = 0.00278 \times C_{10} \times F_y \times I_{y, tc} \times A$$

- where:
- Q_y is peak flow rate (m³/sec) of average recurrence interval (ARI) of "Y" years
 - C_{10} is the runoff coefficient (dimensionless) for ARI of 10 years. Rural runoff coefficients are given in Volume 2, figure 5 of Pilgrim (1998), while urban runoff coefficients are given in Volume 1, Book VIII, figure 1.13 of Pilgrim (1998) and construction runoff coefficients are given in Appendix F.
 - F_y is a frequency factor for "Y" years. Rural values are given in Volume 1, Book IV, Table 1.1 of Pilgrim (1998) while urban coefficients are given in Volume 1, Book VIII, Table 1.6 of Pilgrim (1998)
 - A is the catchment area in hectares (ha)
 - $I_{y, tc}$ is the average rainfall intensity (mm/hr) for an ARI of "Y" years and a design duration of "tc" (minutes or hours)

Time of concentration (tc) = $0.76 \times (A/100)^{0.38}$ hrs (Volume 1, Book IV of Pilgrim, 1998)

Note: For urban catchments the time of concentration should be determined by more precise calculations or reduced by a factor of 50 percent.

Peak flow calculations, 1

Site	A (ha)	tc (mins)	Rainfall intensity, I, mm/hr						C ₁₀
			1 _{yr, tc}	5 _{yr, tc}	10 _{yr, tc}	20 _{yr, tc}	50 _{yr, tc}	100 _{yr, tc}	

Peak flow calculations, 2

ARI yrs	Frequency factor (F _y)	Peak flows						Comment
		(m ³ /s)	(m ³ /s)	(m ³ /s)	(m ³ /s)	(m ³ /s)	(m ³ /s)	

3. Volume of Sediment Basins: *Type C* Soils

Basin volume = settling zone volume + sediment storage volume

Settling Zone Volume

The settling zone volume for *Type C* soils is calculated to provide capacity to allow the design particle (e.g. 0.02 mm in diameter) to settle in the peak flow expected from the design storm (e.g. 0.25-year ARI). The volume of the basin's settling zone (V) can be determined as a function of the basin's surface area and depth to allow for particles to settle. Peak flow/discharge for the 0.25-year, ARI storm is given by the Rational Formula:

$$Q_{tc, 0.25} = 0.5 \times [0.00278 \times C_{10} \times F_y \times I_{1yr, tc} \times A] \text{ (m}^3\text{/sec)}$$

where:

- $Q_{tc, 0.25}$ = flow rate (m³/sec) for the 0.25 ARI storm event
- C_{10} = runoff coefficient (dimensionless for ARI of 10 years)
- F_y = frequency factor for 1 year ARI storm
- A = area of catchment in hectares (ha)

$$\text{Basin surface area (A)} = \text{area factor} \times Q_{tc, 0.25} \text{ m}^2$$

Particle settling velocities under ideal conditions (Section 6.3.5(e))

Particle Size	Area Factor
0.100	170
0.050	635
0.020	4100

$$\text{Volume of settling zone} = \text{basin surface area} \times \text{depth (Section 6.3.5(e)(ii))}$$

Sediment Storage Zone Volume

In the standard calculation, the sediment storage zone is 100 percent of the setting zone. However, designers can work to capture the 2-month soil loss as calculated by the RUSLE (Section 6.3.5(e)(iv)), in which case the "Detailed Calculation" spreadsheets should be used.

Total Basin Volume

Site	$Q_{tc, 0.25}$ (m ³ /s)	Area factor	Basin surface area (m ²)	Depth of settling zone (m)	Settling zone volume (m ³)	Sediment storage volume (m ³)	Total basin volume (m ³)	Basin shape		
								L:W Ratio	Length (m)	Width (m)
		4100								
		4100								
		4100								
		4100								
		4100								
		4100								

4. Volume of Sediment Basins, *Type D* and *Type F* Soils

Basin volume = settling zone volume + sediment storage zone volume

Settling Zone Volume

The settling zone volume for *Type F* and *Type D* soils is calculated to provide capacity to contain all runoff expected from up to the *y*-percentile rainfall event. The volume of the basin's settling zone (*V*) can be determined as a function of the basin's surface area and depth to allow for particles to settle and can be determined by the following equation:

$$V = 10 \times C_v \times A \times R_{y\text{-} \% \text{ile}, x\text{-} \text{day}} \text{ (m}^3\text{)}$$

where:

10 = a unit conversion factor

C_v = the volumetric runoff coefficient defined as that portion of rainfall that runs off as stormwater over the *x*-day period

R = is the *x*-day total rainfall depth (mm) that is not exceeded in *y* percent of rainfall events. (See Sections 6.3.4(d), (e), (f), (g) and (h)).

A = total catchment area (ha)

Sediment Storage Zone Volume

In the standard calculation, the sediment storage zone is 50 percent of the setting zone. However, designers can work to capture the 2-month soil loss as calculated by the RUSLE (Section 6.3.4(i)(ii)), in which case the "Detailed Calculation" spreadsheets should be used.

Total Basin Volume

Site	C_v	<i>R</i> x-day y-%ile	Total catchment area (ha)	Settling zone volume (m ³)	Sediment storage volume (m ³)	Total basin volume (m ³)

J.2 The Detailed Sheet

Note: These “Detailed Calculation” spreadsheets relate only to high erosion hazard lands as identified in figure 4.6 or where the designer chooses to use the RUSLE to size sediment basins. The “Standard Calculation” spreadsheets should be used on low erosion hazard lands as identified by figure 4.6 and where the designer chooses not to run the RUSLE in calculations.

1. Site Data Sheet

Site name: _____

Site location: _____

Precinct: _____

Description of site: _____

Site Area	Site						Remarks
Total catchment area (ha)							
Disturbed catchment area (ha)							

Soil analysis

% sand (fraction 0.02 to 2.00 mm)							Soil texture should be assessed through mechanical dispersion only. Dispersing agents (e.g. Calgon) should not be used
% silt (fraction 0.002 to 0.02 mm)							
% clay (fraction finer than 0.002 mm)							
Dispersion percentage							E.g. enter 10 for dispersion of 10%
% of whole soil dispersible							See Section 6.3.3(e)
Soil Texture Group							See Section 6.3.3(c), (d) and (e)

Rainfall data

Design rainfall depth (days)							See Sections 6.3.4 (d) and (e)
Design rainfall depth (percentile)							See Sections 6.3.4 (f) and (g)
x-day, y-percentile rainfall event							See Section 6.3.4 (h)
Rainfall intensity: 2-year, 6-hour storm							See IFD chart for the site

RUSLE Factors

Rainfall erosivity (R-factor)							Automatic calculation from above
Soil erodibility (K-factor)							RUSLE data can be obtained from Appendixes A, B and C
x-day, y-percentile rainfall event							
Slope length (m)							
Slope gradient (%)							
Length/gradient (LS-factor)							
Erosion control practice (P-factor)	1.3	1.3	1.3	1.3	1.3	1.3	
Ground cover (C-factor)	1	1	1	1	1	1	

Calculations

Soil loss (t/ha/yr)							
Soil Loss Class							See Section 4.4.2(b)
Soil loss (m ³ /ha/yr)							
Sediment basin storage volume, m ³							See Sections 6.3.4(i) and 6.3.5 (e)

2. Storm Flow Calculations

Peak flow is given by the Rational Formula:

$$Q_y = 0.00278 \times C_{10} \times F_y \times I_{y, t_c} \times A$$

- where:
- Q_y is peak flow rate (m³/sec) of average recurrence interval (ARI) of "Y" years
 - C_{10} is the runoff coefficient (dimensionless) for ARI of 10 years. Rural runoff coefficients are given in Volume 2, figure 5 of Pilgrim (1998), while urban runoff coefficients are given in Volume 1, Book VIII, figure 1.13 of Pilgrim (1998) and construction runoff coefficients are given in Appendix F.
 - F_y is a frequency factor for "Y" years. Rural values are given in Volume 1, Book IV, Table 1.1 of Pilgrim (1998) while urban coefficients are given in Volume 1, Book VIII, Table 1.6 of Pilgrim (1998)
 - A is the catchment area in hectares (ha)
 - I_{y, t_c} is the average rainfall intensity (mm/hr) for an ARI of "Y" years and a design duration of "t_c" (minutes or hours)

Time of concentration (t_c) = 0.76 × (A/100)^{0.38} hrs (Volume 1, Book IV of Pilgrim, 1998)

Note: For urban catchments the time of concentration should be determined by more precise calculations or reduced by a factor of 50 percent.

Peak flow calculations, 1

Site	A (ha)	t _c (mins)	Rainfall intensity, I, mm/hr						C ₁₀
			1 _{yr, t_c}	5 _{yr, t_c}	10 _{yr, t_c}	20 _{yr, t_c}	50 _{yr, t_c}	100 _{yr, t_c}	

Peak flow calculations, 2

ARI yrs	Frequency factor (F _y)	Peak flows						Comment
		(m ³ /s)	(m ³ /s)	(m ³ /s)	(m ³ /s)	(m ³ /s)	(m ³ /s)	

3. Volume of Sediment Basins: *Type C* Soils

Basin volume = settling zone volume + sediment storage volume

Settling Zone Volume

The settling zone volume for *Type C* soils is calculated to provide capacity to allow the design particle (e.g. 0.02 mm in diameter) to settle in the peak flow expected from the design storm (e.g. 0.25-year ARI). The volume of the basin's settling zone (V) can be determined as a function of the basin's surface area and depth to allow for particles to settle. Peak flow/discharge for the 0.25-year, ARI storm is given by the Rational Formula:

$$Q_{tc, 0.25} = 0.5 \times [0.00278 \times C_{10} \times F_y \times I_{1yr, tc} \times A] \text{ (m}^3\text{/sec)}$$

where:

- $Q_{tc, 0.25}$ = flow rate (m³/sec) for the 0.25 ARI storm event
- C_{10} = runoff coefficient (dimensionless for ARI of 10 years)
- F_y = frequency factor for 1 year ARI storm
- A = area of catchment in hectares (ha)

$$\text{Basin surface area (A)} = \text{area factor} \times Q_{tc, 0.25} \text{ m}^2$$

Particle settling velocities under ideal conditions (Section 6.3.5(e))

Particle Size	Area Factor
0.100	170
0.050	635
0.020	4100

$$\text{Volume of settling zone} = \text{basin surface area} \times \text{depth (Section 6.3.5(e)(ii))}$$

Sediment Storage Zone Volume

In the detailed calculation on Soil Loss Classes 1 to 4 lands, the sediment storage zone can be taken as 100 percent of the settling zone capacity. Alternately designers can design the zone to store the 2-month soil loss as calculated by the RUSLE (Section 6.3.5(e)(iv)). However, on Soil Loss Classes 5, 6 and 7 lands, the zone must contain the 2-month soil loss as calculated by the RUSLE (Section 6.3.5(e)(v)).

Place an "X" in the box below to show the sediment storage zone design parameters used here:

- 100% of settling zone capacity,
- 2 months soil loss calculated by RUSLE

Total Basin Volume

Site	$Q_{tc, 0.25}$ (m ³ /s)	Area factor	Basin surface area (m ²)	Depth of settling zone (m)	Settling zone volume (m ³)	Sediment storage volume (m ³)	Total basin volume (m ³)	Basin shape		
								L:W Ratio	Length (m)	Width (m)
		4100								
		4100								
		4100								
		4100								
		4100								
		4100								

4. Volume of Sediment Basins, *Type D* and *Type F* Soils

Basin volume = settling zone volume + sediment storage zone volume

Settling Zone Volume

The settling zone volume for *Type F* and *Type D* soils is calculated to provide capacity to contain all runoff expected from up to the y -percentile rainfall event. The volume of the basin's settling zone (V) can be determined as a function of the basin's surface area and depth to allow for particles to settle and can be determined by the following equation:

$$V = 10 \times C_v \times A \times R_{x\text{-day}, y\%ile} \text{ (m}^3\text{)}$$

where:

- 10 = a unit conversion factor
- C_v = the volumetric runoff coefficient defined as that portion of rainfall that runs off as stormwater over the x -day period
- $R_{x\text{-day}, y\%ile}$ = is the x -day total rainfall depth (mm) that is not exceeded in y percent of rainfall events. (See Sections 6.3.4(d), (e), (f), (g) and (h)).
- A = total catchment area (ha)

Sediment Storage Zone Volume

In the detailed calculation on Soil Loss Classes 1 to 4 lands, the sediment storage zone can be taken as 50 percent of the settling zone capacity. Alternately designers can design the zone to store the 2-month soil loss as calculated by the RUSLE (Section 6.3.4(i)(ii)). However, on Soil Loss Classes 5, 6 and 7 lands, the zone must contain the 2-month soil loss as calculated by the RUSLE (Section 6.3.4(i)(iii)).

Place an "X" in the box below to show the sediment storage zone design parameters used here:

- 50% of settling zone capacity,
- 2 months soil loss calculated by RUSLE

Total Basin Volume

Site	C_v	R x-day y-%ile	Total catchment area (ha)	Settling zone volume (m ³)	Sediment storage volume (m ³)	Total basin volume (m ³)



APPENDIX K

K Relevant NSW Legislation

K.1 Environmental Legislation: Urban Areas in NSW

A growing concern is arising within the community that stormwater management needs to be undertaken in an increasingly safe and ecologically sustainable manner. As this awareness evolves, we are finding that the technical, economic, political and social issues surrounding stormwater management are becoming more complex and diverse. In New South Wales, where much of our urban development is close to valuable State-owned beaches and waterways, there are many laws, regulations, policies and guidelines to help protect the environment in NSW and give guidance to business and industry.

Land use planning (LEPs), development control (DCP, DA, BA) and drainage-related powers under the Environmental Planning and Assessment Act and Local Government Act place much of the responsibility for stormwater management with councils.

For soil erosion and stormwater pollution, land developers, owners; builders and utility installers need to ensure that:

- (i) land development projects are implemented according to a stormwater management scheme based on ESD principles;
- (ii) stormwater management schemes are consistent with any stormwater management plans prepared by council and/or Catchment Management Trusts or Catchment Management Boards
- (iii) stormwater management schemes are suited to the natural stability and polluting potential (as indicated by an objective land capability assessment) of the land disturbed by their development;
- (iv) development does not exacerbate, and where possible improves, any existing stormwater management problems affecting council or neighbours;
- (v) stormwater from development and construction does not degrade any wetland, creek, river, estuary or bushland environment – particularly where this forms habitat for native fauna; and
- (vi) stormwater management schemes include approved soil and water management practices with:
 - designs that properly reduce the risk of stormwater pollution to a level that is acceptable to council and the surrounding community
 - maintenance schedules that provide for proper operation of the treatment practices until erosion and pollution hazards have been permanently returned to predevelopment levels
 - sufficient monitoring of the systems and measures to justify claims for proper operational effectiveness.

Everyone needs to be aware of his or her responsibilities for stormwater management under the Protection of the Environment Operations Act 1997, and the Water Management Act, 2000. Landowners, developers, builders and utility providers can be affected by environmental legislation including:

- Environmental Planning and Assessment Act, 1979
- Protection of the Environment Operations Act 1997,
- Water Management Act 2000
- Rivers and Foreshores Improvement Act, 1948
- Native Vegetation Conservation Act 1997
- Soil Conservation Act, 1938
- Catchment Management Act, 1989
- The Local Government Act, 1993
- Fisheries Management Act, 1994
- Actions at Common Law.

K.2 Environmental Planning and Assessment Act, 1979 (EP&A Act)

The EP&A Act establishes a system of environmental planning and assessment under the overview of the Department Infrastructure, Planning and Natural Resources (DIPNR) and, usually, local implementation by Councils. Instruments to allow forward planning for urban stormwater issues at different scales of detail include:

- State Environmental Planning Policies (SEPP)/(DIPNR)
- Regional Environmental Plans (REP)/(DIPNR)
- Local Environmental Plans (LEP)/(council)
- Development Control Plans (DCP)/(council).

These environmental planning instruments state what developments are permissible and whether consent is required from a “Consent Authority” (council) under Pt IV. If Pt IV does not apply, environmental impact assessment takes place under Pt V.

Consent Authorities must review specific “Heads of Consideration” outlined in s. 90 of the Act. “Heads of Consideration” include:

- (i) potential of development to affect the physical environment, including any proposals to prevent or mitigate effects that might prove deleterious to neighbourhood values;
- (ii) potential to reduce the scenic quality of the locality;
- (iii) potential to cause soil erosion and water pollution;
- (iv) representations from parties with responsibility or interest in the development site and/or its surroundings; and
- (v) matters raised in environmental planning instruments, viz. SEPP, REP, LEP, DCP.

Consent Authorities may:

- approve development as proposed
- approve development with conditions
- not approve development.

In issuing consent, authorities may require a contribution under s. 94 to finance public amenities to meet new demands created by the development. These can include drainage and water quality structures to cope with the increased pollution from urbanisation at the locality.

Authorities cannot require s. 94 contributions to redress past deficiencies in stormwater controls. However, introducing new strategies and techniques that improve stormwater quality is possible for developers, even where degraded by past developments.

K.3 Protection of the Environment Operations Act 1997 (POEO Act)

POEO Act is the main piece of environmental legislation covering water, air, and noise pollution and waste. Under the POEO Act the Department of Environment and Conservation (DEC, incorporating the former EPA) is generally the appropriate regulatory Authority for large industrial and waste facilities (which are licensed by the DEC) as well as for work carried out by local government or its contractors. Local Councils are the appropriate authority for almost everything else.

The POEO Act gives the appropriate regulatory authority the powers to issue clean-up notices, and issue on the spot fines or commence prosecutions where environmental laws have not been complied with. Clean up and prevention notices are issued to require clean-up action when pollution has occurred, or require an activity to be carried out in an environmentally satisfactory manner.

You are required to notify your local council or the DEC, whichever is the appropriate regulatory authority, in the event of a pollution incident, which causes or threatens material environmental harm.

All businesses have a legal and moral responsibility towards the environment. Under the law this is called 'due diligence'. Due diligence means that all employers, managers, directors and occupiers:

- must take all reasonable steps to prevent pollution and protect the environment;
- must promote action to prevent or minimise potential environmental damage;
- must show that all that could have been done to prevent an accident from occurring has been done;
- should make sure that all precautionary and control measures are in place,

and are regularly checked and maintained, to minimise the risk of a pollution incident (these measures might include an environmental management plan, staff training and supervision, and an environmental audit and review process.)

Building site managers have the responsibility to manage the following environmentally degrading and pollution sources:

- air pollution, including dust and smoke
- noise that might interfere with neighbouring lifestyles
- waste discharges including leakage or spills of construction materials, soil, sand, gravel slurries and concrete
- trade and domestic rubbish, including packaging, off-cuts and spoiled materials
- toxic chemicals, including fuels, paints, solvents, sealants, adhesives, lubricants and pesticides.

The Penalties for not acting within the law are divided into Tiers 1, 2 and 3 respectively. The most serious offences (called Tier 1 offences in the POEO Act) are for wilful or negligent breaches that harm the environment. These carry penalties of up to \$1 million for a corporation, and up to \$250,000 or 7 years imprisonment or both, for an individual.

For Tier 2 offences the maximum penalties for most pollution offences carry penalties of \$250,000 for companies and \$120,000 for individuals. Minor breaches for water pollution can result in an infringement notice with penalties of \$1,500 for companies or \$750 for individuals.

K.4 Rivers and Foreshores Improvement Act, 1948

The Rivers and Foreshores Improvement Act, 1948, is administered by DIPNR for regulating operations involving excavation and fill within the immediate vicinity of coastal rivers, lakes and estuaries. Under this Act, a Part 3A Permit is required for the undertaking of works within 40 metres of the bed and banks of a watercourse.

By late 2003, the Water Management Act 2000 (WMA) will have repealed the Rivers and Foreshores Improvement Act, 1948 (RFIA). When this occurs, activities that require a Permit under Part 3A Approvals under the RFIA will require Controlled Activity Approvals under the WMA.

Appendix I provides details of the requirements of to obtain a Controlled Activity approval.

K.5 Soil Conservation Act, 1938

The Soil Conservation Act is administered by DIPNR for the purposes of conserving soil and water resources and mitigating soil erosion. The Act has other specific provisions that are relevant to urban developments. These include:

- (i) Section 15A Notices, allow the DIPNR to prescribe measures of erosion and sediment control that must be adopted before a development can go on. These conditions can be pre-emptive. Alternatively, a Notice can stop an offending operation or suspend its progress until proper erosion and sediment controls are instituted. In case of the non compliance with a 15A Notice the DIPNR can undertake the specified work and recover full cost from the developer;
- (ii) Section 10 Projects provide a mechanism under which the DIPNR can provide incentives for erosion and sediment control works undertaken cooperatively by land holders for the benefit of community water resources. Such arrangements provide for more effective and efficient measures in erosion and sediment control in upper catchment areas – at a saving to heavily engineered, end-of-pipe solutions.

NB: The protected Land provisions (previously Part 4, Division 2) are now included as State protected land in the Native Vegetation Conservation Act, 1997

K.6 Native Vegetation Conservation Act, 1997

The Native Vegetation Conservation Act is administered by DIPNR for conserving and managing native vegetation and regulating clearing of vegetation according to the principles of ecologically sustainable development.

Clearing of native vegetation, or clearing on protected land, can only be carried out:

- with development consent from DIPNR; or
- if it is consistent with an approved Regional Vegetation Management Plan; or
- if it is consistent with the exemptions in the Act (see section 12 of the Act, and also those carried forward from SEPP 46, the Soil Conservation Act and the Western Lands Act) or
- if it is on land otherwise excluded from the Act (such as part or whole local government areas - see section 9 and Schedules 1 & 2 of the Act).

Where the Act has been, or is about to be breached, DIPNR can impose stop work notices to halt clearing, or remedial notices directing that restoration work be carried out. Offences under the Act, including unauthorised clearing and failing to comply with a notice, are pursued in the Land and Environment Court. The maximum penalty is currently \$110,000.

K.7 The Local Government Act, 1993

The Local Government Act empowers councils to construct, control, deliver and manage facilities, services and programs that directly affect the environment. Specifically, it requires councils to "... properly manage, develop, protect, restore, enhance, and conserve the environment for which it holds responsibility ...". It gives councils a mechanism for charging a levy on rateable land to help fund its environmental programs.

The Act requires that councils ensure that the development proposals they approve comply with relevant legislation and local policy. Additionally, councils are bound specifically to consider protection of the environment as well as public health and heritage matters.

Approval from council is required for many activities that may affect urban stormwater management.

These include:

- erection, alteration or demolition of buildings
- undertaking work on water supplies
- undertaking work on stormwater drainage systems
- undertaking work to sewerage or other effluent disposal facilities
- connecting private drainage to community systems
- disposing of waste to council sewers
- installing or removing relocatable buildings.

Also, the Act authorises councils to issue s. 124 Orders that require an owner or developer to do, or to refrain from doing, things deemed by council to be in the interests of preventing, constraining or repairing environmental damage to drainage works or natural watercourses. "Environmental damage" in these instances includes unauthorised stormwater drainage works, wastage of water, discharge of prohibited substances, and pollution of public water supplies. Fines are prescribed for offences under this section.

K.8 Catchment Management Act, 1989

The Catchment Management Act provides statutory basis for implementing policies of total catchment management (TCM). Total Catchment Management is a philosophy to balance social, economic and environmental concerns to enable sustainable development. It emphasises sound land and water management in the upper catchment to reduce the need for end-of-pipe solutions in the lower catchments and receiving waters. It provides financial, technical and political means for the resident community and various arms of government to work together for more efficient and effective results in land and water matters.

The Act provides for the appointment of either Catchment Management Trusts or Catchment Management Boards with a brief to coordinate land, water and vegetation management on a catchment-wide basis and in the best interests of the catchment community. This legislation and these arrangements are currently under review, however, to facilitate the establishment and operation of Catchment Management Authorities throughout NSW.

K.9 Fisheries Management Act, 1994

The Fisheries Management Act defines the responsibilities of NSW Fisheries in respect of protecting fisheries and fish habitat. It requires NSW Fisheries to ensure that development do not effect aquatic environments adversely. In this regard approved development must be shown to have either:

- no direct adverse impact on fish and fisheries or
- any unavoidable adverse impacts eliminated by compensatory measures.

The Act specifically requires builders and developers to have proper regard for protecting fish habitats and give NSW Fisheries sufficient information to assess any application for a permit to disturb fish habitats. Where appropriate, developers can be required to prepare a Fish Habitat Protection Plan that will form part of the normal environmental planning process required by the EP&A Act.

Other specific NSW Fisheries' policies include:

- (i) tertiary treatment as well as nutrient removal is required wherever a possibility exists that organic pollutants will be discharged to a waterway;
- (ii) gross pollutant traps, sediment basins, and artificial wetlands are required to prevent sediment and nutrient pollutants from urban development entering fisheries. An area equivalent to 5 percent of the developed area is to be incorporated into nutrient retention basins;
- (iii) proper planning consideration is to be given to dilution, assimilative capacity, and existing uses of waterways likely to receive urban stormwater discharges;
- (iv) disposal of polluted stormwater to natural wetlands, seagrass beds and aquatic reserves is prohibited and no outlet is allowed within 50 metres of such an area;
- (v) stormwater from roads, car parks and other similar paved surfaces must be discharged well away from aquatic habitats;
- (vi) waters likely to have elevated levels of nitrogen and phosphorus must be managed not to encourage outbreaks of blue-green algae;
- (vii) discharge of waters likely to carry pesticides and heavy metals that can be bio-accumulated by marine organisms, to waterways, is prohibited; and
- (viii) discharge of large volumes of fresh water, likely to re-suspend bottom sediments, reduce salinity by more than 22,000 ppm, raise long-term turbidity, or raise water temperature should be avoided near aquaculture, particularly oyster farms.

K.10 The Water Administration Act, 1986

The Water Administration Act is used by the DIPNR to create a Water Administration Ministerial Corporation with executive powers over the use, flow and control of

community water resources within New South Wales. As such, the Corporation has powers in respect of stormwater received by State-owned waters and has interest in:

- water conservation, supply and replenishment for commercial users
- water quality and pollution control
- flooding
- protection of, and provision for, aquatic environments.

The Act has state-wide coverage but its greatest application is to management of inland river systems.

K.11 Noxious Weeds Act, 1993

The Noxious Weeds Act, 1993, emphasises community cooperation to ensure a coordinated approach to the control of Noxious Weeds throughout New South Wales. It covers rural and urban problems, including environmental weeds.

Section 15 of the Act requires an occupier of land (other than a local control authority) on which there is a notifiable weed to notify the local control authority of that fact within three days of becoming aware that the notifiable weed is on the land. A listing of notifiable weeds is available from local offices of NSW Agriculture.

Penalties range to \$10,000 for failing to comply with notices in this regard. Authorities are also able to charge landholders for the cost of any follow-up inspections required after the issue of weed control notices, or for the cost of eradicating noxious weeds where the landholder has failed to comply with a notice.



APPENDIX L

CD Contains:

- Graphs showing Y-percentile, X-day rainfall depths (mm) for 59 sites across New South Wales
- Graphs for interpolation of rainfall depths at locations or for time periods not listed above
- Excel spreadsheets for estimating the size of sediment retention basins (as shown at Appendix J)



APPENDIX M

M Model Code of Practice for Soil & Water Management on Urban Lands

Intent

The following Code of Practice is applicable to urban subdivision and building activities. The Code's purpose is to minimise the effect of soil erosion and stormwater pollution resulting from land development. It is designed to give consent authorities a model that can be easily adapted to their own needs, while also applying to those of government agencies and industry. It seeks to impose the least onerous conditions consistent with ecologically sustainable development.

Scope

All urban development activities are covered by this Code where these might result in pollution of receiving waters and more than 250 square metres of land will be disturbed. The activities include the building of single dwellings through to large-scale, "green field" subdivisions.

Different levels of control are required depending on how much land is being disturbed and the type of activity (Table M1).

Table M1 Scope of requirements for the Code of Practice

Area of Disturbance (m ²)	Nominal type of activity	Scope of works
<250	house extensions, small driveways, garages	not covered by this Code
250 to 2,500	long driveways, most houses, small commercial developments, small subdivisions, medium/high density housing developments, small civil works	ESCP Plan addressing soil erosion and sediment pollution only
>2,500	large subdivisions, large civil works, large medium/high density housing, etc.	SWMP Plan addressing soil erosion and pollution by sediment, including nutrients held on sediment particles, including a calculation as to the need for a sediment basin

The Code does not address activities that, clearly, are not considered urban “development”, such as farming, market gardening, highway construction and equestrian activities. It covers the whole process of construction, from initial planning of urban works through to the completion of the construction phase and subsequent rehabilitation. It outlines requirements for BMPs applicable to the construction phase, including:

- controlling run-on water
- marking out areas to be disturbed
- stripping and stockpiling of topsoil/reshaping the site
- controlling movement of water on, through and off the site
- generally, managing the impacts of works
- rehabilitation (including revegetation).

Other Needs

It is hoped that consent authorities throughout New South Wales will adopt this model Code so that similar standards apply to development. This can be achieved by replacing “[the consent authority]” in this text with the name of the appropriate organisation, e.g. Wollondilly Shire Council. Further, it is anticipated that consent authorities will make available to prospective developers maps of their area of influence at suitable scales (1:25,000) and containing information for:

- soil erodibility
- Soil Loss Classes
- Soil Hydrologic Group
- Soil Texture Group
- percent of whole subsoil likely to be dispersible
- other data relevant to local needs.

Alternately, consent authorities will provide copies of the relevant sections of Appendixes B and C of *Managing Urban Stormwater - Soils & Construction*, Landcom (2004) and other information about rehabilitation. Nevertheless, it is expected that developers will collect their own site-specific information where:

- the data, above, are not generally available
- the development is regarded as “environmentally sensitive”.

Consent authorities might have local needs that go beyond this model Code and will be addressed in other areas.

General Planning Requirements

Unless otherwise marked, each paragraph applies to all urban works’ activities, including building, subdivision and infrastructure development.

1. Erosion & Sediment Control Plans (ESCPs) are required where between 250 and 2,500 square metres of land will be disturbed for:

- (i) single dwellings and other developments if approval is required from the consent authority; and
- (ii) minor civil infrastructure works, including:
 - urban and minor rural road construction and reconstruction
 - stormwater, sewerage and water pipelines, including culverts in urban areas
 - bulk earthworks, including retention basins and sports fields
 - electricity, telephone and natural gas lines in urban areas.

Nevertheless, [the consent authority] might vary this requirement especially where, in their view:

- a high risk of polluting receiving waters exists, i.e. require a *SWMP*; or
 - a very low risk of polluting receiving waters exists, i.e. waive the need for an *ESCP*.
2. Soil and Water Management Plans (*SWMPs*) are required for all development works where more than 2,500 square metres of land will be disturbed and/or where development consent is required.
 3. Any *SWMP/ESCP* (Plans) will, when approved, create an agreement of intent between [the consent authority], Government Agencies, Government Business Enterprises, corporations and private landholders. All site works must be carried out following the approved Plan or as varied by the designer with the concurrence of [the consent authority].
 4. *SWMP/ESCP* (Plans) must be prepared by suitably experienced people. Suitably experienced people include those approved by the consent authority or those certified^[1] by:
 - the Institution of Engineers, Australia, for engineering and hydrology matters
 - the International Erosion Control Association for soil conservation matters
 - the Australian Society of Soil Science for collection or analysis of soil data.
 5. Where development consent is not required, earthworks may only be undertaken if:
 - (i) the shape of the land is not materially altered;
 - (ii) the land on which this work is undertaken is not:
 - regarded as waterfront land (Appendix I)
 - steeper than 1(V):4(H) (approximately 14o from the horizontal)
 - designated by [the consent authority] as geotechnically unstable
 - subject to any other State or Council legislative provisions; and

1. Agencies are currently discussing the concept that only certified people will be able to prepare Plans after 1 July 2004.

-
- (iii) the activity does not:
- affect any native habitat vegetation or tree of significance without the written notice of [the consent authority] (including by lopping, removal, undermining, filling around or otherwise injuring)
 - include cut or fill greater than 1 metre
 - affect a land area greater than 250 square metres.
6. Any earthworks that cause significant disturbance to the soil surface and are ancillary to any purpose for which [consent authority] approval is required, must not be started before the issue of that approval. Further, these earthworks must only be undertaken following any Plans attached to the approval.
7. A Controlled Activity Approval must be gained from the Department of Infrastructure Planning and Natural Resources (DIPNR) on waterfront land before any of the following works are undertaken:
- (i) the erection of a building or the carrying out of a work (within the meaning of the Environmental Planning and Assessment Act 1979), or
 - (ii) the removal of material (whether or not extractive material) or vegetation from land, whether by way of excavation or otherwise, or
 - (iii) the deposition of material (whether or not extractive material) on land, whether by way of landfill operations or otherwise, or
 - (iv) the carrying out of any other activity that affects the quantity or flow of water in a water source.

The Approval must be submitted to the council before beginning any work.

8. Before the commencement of construction activities, the developer must nominate a representative to [the consent authority] in writing who has authority to:
- ensure compliance with the conditions in this Code and described on the approved Plan
 - undertake additional practical measures and modify design to prevent or reduce pollution of waters
 - inform [the consent authority] of such additional measures when practicable.

Environmental Bond

9. Before starting construction activities, the applicant must provide to [the consent authority] an environmental bond that takes one of the following forms:
- a security, such as a Deed of Agreement in a form satisfactory to [the consent authority]
 - a deposit as a bank cheque from an approved financial institution
 - other financial guarantee.

[The consent authority] will permit the bond to be transferred from one development to another.

10. The amount of the bond shall be as follows:

Area of lands to be disturbed (m ²)	Amount
less than 999	nil
1,000 or more	\$2,000 plus \$1 for each ten (10) square metre of disturbed land in excess of 1,000 to a maximum total payment of \$20,000.00

11. An amount may be forfeited from the security deposit or bond where, in the view of [the consent authority]:

- (i) a developer/builder/applicant has failed in his or her duty of care to the approved Plan; and
- (ii) this has placed surrounding environments at an unacceptable risk from soil erosion or stormwater pollution.

The amount of the forfeiture in these cases will be determined by a demerit system detailed as (Attachment 3)^[2]

12. The environmental bond may be partially released during the construction phase:

- (i) upon the developer demonstrating diligent completion and operational readiness of works specified in the Plan; or
- (ii) at agreed rates corresponding to completion of development stages.

However, the residual bond amount must not be less than the cost of implementing the Plan over the remainder of the construction period.

13. Final release of the Environmental Bond must not occur before rehabilitation or landscaping is installed. Sometimes, maintaining temporary rehabilitation is acceptable providing C-factors are kept at less than 0.05 always (e.g. 70 percent grass cover, Attachment 1).

SWMP/ESCP Content

14. All Plans must accord with the guidelines presented in Chapter 2 of Managing Urban Stormwater – Soils & Construction, Landcom (2004). The principles of Total Catchment Management and ecologically sustainable development are strongly encouraged.

2. The monies collected from such forfeiture will be transferred to an environmental collections fund for financing strategies or rectifying damage or establishing devices onsite that improve the protection of the environment from soil erosion and stormwater pollution.

15. On smaller sites (where less than 2,500 square metres of land is disturbed), show:

- (i) the following background information on the drawing(s):
 - location of site boundaries and adjoining roads
 - approximate grades and indications of direction(s) of fall
 - approximate location of trees and other vegetation, showing items for removal or retention (consistent with any other plans attached to the application)
 - location of site access, proposed roads and other impervious areas (e.g. parking areas and site facilities)
 - existing and proposed drainage patterns with stormwater discharge points
 - north point and scale.
- (ii) how the various soil conservation measures will be carried out on site on a separate commentary, including:
 - timing of works
 - locations of lands where a protective ground cover will, as far as is practicable, be maintained
 - access protection measures
 - nature and extent of earthworks, including the amount of any cut and fill
 - where applicable, the diversion of runoff from upslope lands around the disturbed areas
 - location of all soil and other material stockpiles including topsoil storage, protection and reuse methodology
 - location and type of proposed erosion and sediment control measures
 - site rehabilitation proposals, including schedules
 - frequency and nature of any maintenance program
 - other site-specific soil or water conservation structures.

16. On larger sites (where more than 2,500 square metres of land are disturbed), identify all items listed in clause 15, above, as well as:

- (i) the following information:
 - the location of lots, public open space, stormwater drainage systems, schools, shopping/community centres
 - the location of land designated or zoned for special uses
 - existing site contours;
- (ii) the location and general diagrammatic representations of all necessary:
 - erosion and sediment control BMPs;
- (iii) location and engineering details with supporting design calculations for all necessary:
 - sediment basins; and
- (iv) location and basic details of any other facilities proposed to be included as part of the development or works, such as:
 - constructed wetlands

- gross pollutant traps
- trash racks or trash collection/separator units.

Detailed design criteria for these latter facilities should be sourced from other manuals/reports and are not an integral part of a construction phase SWMP. Usually they are considered as a separate function of the development approval process.

17. Specify the scale, type, operation and maintenance of all soil and water management devices in the soil and water management program. Include maps and/or specifications of measures proposed to control soil erosion and pollution by sediment.

Access and Roads

18. Vehicular access must be confined to approved areas. Where practicable, access must be stabilised and confined to one location.

19. Runoff from access surfaces must be drained into a nearby sediment-trapping device before leaving the site. Where appropriate, devices to remove soil materials from vehicles must be placed at site exit locations.

20. On subdivisions, priority must be given to road and road shoulder stabilisation based on erosion hazards. Where circumstances preclude the sealing of road shoulders and/or the construction of kerbs and guttering, and:

- (i) where grades permit grass shoulders (usually less than 5 percent), the shoulders and associated table drains must be topsoiled and turfed, having dimensions that simplify maintenance mowing; and
- (ii) where grades do not permit grass shoulders (generally more than 5 percent), the shoulders and associated table drains must be stabilised with appropriate erosion control measures (e.g. jute mesh and bitumen, cross drains, erosion matting, etc.) and revegetated.

21. Where practical on subdivisions, newly sealed hardstand areas must be swept thoroughly after sealing/surfacing to prevent excess aggregate or gravel entering street drains.

Clearing Vegetation

22. Nothing in this Code releases any person, proponent, council or authority from their obligations under the Native Vegetation Conservation Act, 1997. Further, approval given for clearing does not exempt anyone from requirements to:

- obtain additional approval as might be required by other government agencies
- meet the requirements of other legislation.

23. Site clearing for ground survey, geotechnical investigation or other purposes can be undertaken without development consent or approval, provided the work:

-
- is consistent with the Council's Tree Preservation Order and/or policy
 - is undertaken so that the ground surface is not disturbed and at least 150 mm stubble remains on the surface
 - is to provide site access with a minimum number of corridors
 - is on land that is not subject to SEPP 14 (Coastal Wetlands), SEPP 19 (Bushland in Urban Areas), SEPP 26 (Littoral Rainforests), or SEPP 44 (Koala Habitat Protection)
 - is on land that is not subject to the Native Vegetation Conservation Act, 1997 (see section 9 of the Act)
 - only involves clearing that is excluded from the operation of the Native Vegetation Conservation Act, 1997 (see section 12 and Schedule 4 of the Act)
 - involves erection of a fence within 1 metre of the boundary of lands owned or occupied by different persons
 - involves maintenance of services and utilities by [the consent authority] or public authorities
 - involves the destruction of weeds declared under provisions of the Local Government Act, 1993, or
 - involves removal of trees in conformity with AS 2870.2-1996 for specific sites.
24. Consent is not required for clearing where that work is carried out following a notice issued for excess vegetation and/or noxious weeds under the Noxious Weeds Act, 1993 or the Local Government Act, 1993.
25. Clearing for the erection of a building for which development consent is not required must:
- (i) be accordance to [the consent authority's] LEP, Tree Preservation Policy and SEPPs 14, 19, 26, and 44 and the Native Vegetation Conservation Act, 1997; and
 - (ii) be limited to land within 3 metres of the outermost projection of a building (or other structure), a permanent driveway, access way, or car park. The distance required can be varied to accord with AS 2870-1996 (Australian Standard: Residential Slabs and Footings – Construction) on reactive soils.
26. The positive role of vegetation in protecting the ground surface from erosion must be used minimising the removal or disturbance of trees, shrubs and ground covers.
27. Where other studies, reports or consent conditions have identified specific requirements to be addressed in environmentally sensitive areas identified by [the consent authority], then SWMPs shall:
- (i) show how appropriate measures will be taken to ensure that the activity does not unnecessarily affect any vegetation or trees of significance unnecessarily, including any process of lopping, removal, undermining, filling around or otherwise injuring them;

- (ii) be prepared by a suitably qualified person as approved by [the consent authority]; and
- (iii) be submitted to the [the consent authority] for approval.

28. On building sites:

- (i) the footpath or nature strip must not be disturbed by construction activities other than where shown on the Plan for:
 - access to the site
 - installation of services
 - other works specifically approved by [the consent authority]; and
- (ii) removal and disturbance of vegetation must be confined to:
 - the approved building envelope area and/or permanent access ways
 - areas within 3 metres of the outermost projection of approved works and storage areas (or as required by other authorities).

Retained vegetation must be protected by a suitable barrier.

29. For subdivisional work:

- (i) clearing for works must be limited to 5 (preferably 2) metres from the edge of any essential construction activity as shown on the engineering plans;
- (ii) where practicable to do so, development must be phased, with clearing undertaken only with the development of each stage; and
- (iii) understorey ground cover vegetation may be slashed, except in areas shown on the plan, providing ground surface disturbance is minimised and a rubber-tired vehicle is used.

30. All reasonable care must be taken to protect other vegetation from damage during construction. This might involve:

- clearly marking trees to remain
- avoiding compaction of ground within the drip line of trees to remain
- clearly delineating the area of disturbance and keeping all vehicles, building materials and refuse within that area
- limiting the number of access points to the site
- clearly restricting access to "no go" areas.

31. No vegetation will be removed before approval by [the consent authority] to start work on any stage and not before the approved sediment control measures are in place.

32. Vegetation can be removed either without consent or to accord with approved plans for the purposes detailed in clause 23.

33. Where practical for subdivision and infrastructure works, vegetative debris must be salvaged either as logs or as woodchip for later reuse to control erosion or to

rehabilitate the site. Non salvageable materials, such as stumps and roots, can be removed.

Site Works

34. Site disturbance must not be undertaken before the issue of appropriate approvals.
35. Where works do not require approval, they can be undertaken provided they are in accordance with clause 5.
36. Where practicable, schedule the construction program to minimise the potential for soil loss so that the time from the beginning of land disturbance activities to rehabilitation is less than six months. Further, on lands with a high erosion hazard:
- (i) attempt to confine land disturbance to those times of the year when the rainfall erosivity is low; or
 - (ii) show special measures on the Plan to address the high erosion hazard.
37. Site excavation must be designed and located with an aim to minimise cut and fill requirements.
38. Runoff and erosion controls must be installed before clearing and must include:
- (i) diversion of upslope runoff around cleared and/or disturbed areas or areas to be cleared and/or disturbed, providing that:
 - such diverted water will not cause erosion
 - the upslope catchment area is more than 2,000 square metres
 - waters are diverted to a legal discharge point;
 - (ii) sediment control fences or other measures at the downslope perimeter of cleared and/or disturbed areas to prevent unwanted sediment and other debris escaping from the land; and
 - (iii) maintenance of all erosion control measures at operational capacity until the land is effectively rehabilitated.
39. On sites where more than 1,000 square metres are to be disturbed, runoff and erosion controls must also include:
- (i) protection of areas to remain undisturbed through the erection of barrier fencing; and
 - (ii) measures to restrict slope length to 80 metres unless other surface stabilising compensatory measures are applied.
40. Where possible, topsoil must be stripped only from those areas designated on the approved Plan and must be stockpiled for later use in rehabilitation and landscaping.
41. Stockpiles (topsoil, spoil, subsoil, sand, or otherwise) must be:
- (i) located at least 2 metres from any hazard areas, including surfaces with grades

greater than 15 percent, zones of concentrated flow, driveways, footpaths, nature strips, kerb line gutters, swales or standing vegetation;

- (ii) protected from upslope stormwater surface flows;
 - (iii) provided with sediment filters downslope; and
 - (iv) provided with a protective cover that reduces the C-factor (Attachment 1) on bare surface areas to 0.15 or less where they are unlikely to be worked for more than 20 working days.
42. For subdivisional and infrastructure works, fill batters should be located to avoid established trees. Where this is not possible, advice from a tree surgeon or [the consent authority] should be obtained to minimise damage to affected tree(s). Where retention is not practicable, the affected tree(s) must be removed to maintain slope stability.
43. For infrastructure works trenches must be backfilled, compacted to 95 percent standard compaction, and capped with topsoil up to the adjoining ground level. The ground then must be turfed or sown with an approved seed and fertiliser mix.
44. Excess soil may be retained onsite provided the stockpile area is prepared by stripping topsoil from beneath the fill site and respreading it later over affected areas.
45. Trails and tracks for control of bushfires may be constructed and maintained providing they comply with:
- the appropriate council bushfire prevention and control policy
 - the DIPNR's Guidelines for fire trail construction and maintenance
 - Section 41A of the Bush Fires Act, 1949.
46. Lands must be rehabilitated at the completion of all maintenance works where ground disturbance has occurred following clause 69.
47. All sediment control measures must be maintained at, or above their design capacity.
48. Where more than 2,500 square metres of land are disturbed, a self-auditing program must be developed for the site. A site inspection using a Log Book or Inspection Test Plan (ITP) must be undertaken by the site supervisor:
- at least each week
 - immediately before site closure
 - immediately following rainfall events that cause runoff.
- The ITP can take the form of a checklist, completed by simple tick and brief comment entries.
49. The self-audit must be undertaken systematically onsite (e.g. walking anticlockwise from the main entrance) and recording:
- installation/removal of any BMPs
 - the condition of each BMP employed, noting whether it is likely to continue in an effective condition until the next self-audit

-
- circumstances contributing to damage to any BMPs, accidental or otherwise
 - storage capacity available in pollution control structures, including:
 - waste receptacles and portable toilets
 - trash racks
 - sediment barriers and traps
 - gross pollutant traps
 - wetlands/water quality control ponds
 - time, date, volume and type of any additional flocculants
 - the volumes of sediment removed from sediment retention systems, where applicable, and the site where sediment is disposed
 - maintenance requirements (if any) for each BMP
 - circumstances contributing to the damage to BMPs
 - repairs affected on erosion and pollution control devices.

50. Signed, completed logbooks or ITPs must be available onsite and available for council officers, officers of the NSW DEC or any other bona fide person who might seek to review them (Attachments 3 and 4).

51. Irregularities noted by such bona fide persons must be dealt with immediately. If there is a breach or infringement of conditions, action will be taken consistent with the nature and seriousness of the breach or infringement. Actions taken by council (Attachment 5) can include:

- issue of a "Stop Work Notice"
- recording of demerit points that can result in forfeiture of part or all of the Environmental Bond
- a fine under provisions of the Protection of the Environment Operations Act, 1997 (Attachment 5)
- notice to comply pending reinspection of the site.

Stormwater Control

52. When building roof structures are in place, roof water is to be managed in a manner that reduces the likelihood of erosion. The stormwater system must prevent sediment from being eroded from the site and deposited downstream. The roof water system must be functional before roof runoff begins.

Pollution Control

This section applies only to sites where a *SWMP* is required (clause 2) or where, in [the consent authority's] view, the lands have a very high pollution hazard.

53. All pollution control measures and facilities must be installed and stabilised before other site earthworks or measures are commenced including stormwater diversion facilities.

54. Sediment basin(s) must be constructed where the calculated total annual soil loss from the disturbed lands is more than 150 cubic metres. Where the calculated basin size is less than 150 cubic metres, other erosion and sediment control devices can be installed instead.
55. Where sediment basins are required, construct these upstream of any wet ponds or receiving waters and, preferably, off-line.
56. A marker must be placed within each sediment retention basin to show the level above which the design capacity occurs. Advice about whether the basin is intended to be temporary or permanent must be provided by the proponent.
57. Where sediment retention basins are required, they must be designed to treat the design rainfall event sediment-laden stormwater emanating from the site during the subdivision works. They must remain in place at least until the developer has fulfilled all conditions of development consent. [The consent authority] can take over responsibility for the basin(s) or, alternatively, request the developer remove them after all compliance with all relevant consent conditions.
58. Where eroding soils contain more than 10 percent of dispersible fines:
 - (i) all waters captured in sediment basins must be treated with an approved flocculating agent. This treatment should ensure that discharges from such basins contain no more than 50 milligrams per litre of non filtrable residues or as specified in [the consent authority's] Stormwater Management Plan. Following settlement of soil materials, the structure must be pumped out using a floating skimmer collection device. [The consent authority] might consider approval of alternative options for flocculation or stored water removal where appropriate technical documentation is provided;
 - (ii) sediment retention basins must be maintained at a low water level in readiness for treatment and discharge of further runoff. All sediment captured in basins must be treated and discharged within two to 20 days of the cessation of a rainfall event depending on the appropriate design criteria; and
 - (iii) a minimum stockpile of flocculating agents must be retained onsite to provide for at least three complete treatments. It must be stored in a secure undercover location.
59. All sediment control structures described on a *SWMP* or in this Code must be operated and maintained in an effective operational condition by following good engineering practice. A maintenance program must be established that should ensure that accumulated sediment does not impinge on the capacity of the settling zone up to the design storm event. Solid materials removed from sediment retention basins must be disposed of in a way that does not pollute waters.
60. Suitable all-weather access must be provided to all wetlands, sediment basins, detention basins and trash racks to ensure clearing and maintenance programs will not be compromised by inclement conditions.

-
61. Where practicable to do so, surface waters from any undisturbed lands must be diverted away from pollution control equipment to prevent contamination of clean runoff.
 62. Appropriate measures must be provided to ensure that works do not cause flooding, erosion or scour. Such works include diversion and drainage structures, spillways, weirs, pipes and channels.
 63. Chemical products, including petroleum, must be prevented from entering the stormwater system or contaminating the soil. Where necessary, impervious bunds must be constructed around all storage areas with an enclosed volume large enough to contain 110 percent of the volume held in the largest tank.
 64. Adequate trade waste and litterbins must be provided onsite and serviced regularly.
 65. Concrete wastes or washings from concrete mixers must not be deposited in any location where those wastes or washings can flow, or can be washed into any areas of retained vegetation or receiving waters.

Rehabilitation and Landscaping

66. All ground disturbed because of the development must be progressively stabilised and rehabilitated so that it no longer acts as a source of sediment.
67. Other than on the footpath or nature strip, additional ground disturbance for final rehabilitation work may be undertaken without consent, if such work satisfies all other requirements of this Code.
68. Reduce the C-factor to less than 0.15 (e.g. greater than 50 percent grass cover, Attachment 1) on all lands, stockpiles and other exposed materials scheduled to remain unattended for more than 20 working days.
69. Schedule the final rehabilitation or landscaping program so that less than 20 working days will elapse from final land shaping to permanent rehabilitation. Sometimes, maintaining temporary rehabilitation is acceptable providing the C-factor is less than 0.05 (e.g. greater than 70 percent grass cover, Attachment 1). Here, rehabilitation is defined two ways, depending on rainfall erosivity:
 - (i) In periods of expected low rainfall erosivity during the rehabilitation period, achieve a C-factor of 0.15 and keep it there by vegetation, paving, armouring, etc.^[3]

3. Attachment 1 shows that C-factors of 0.15 can be achieved in various ways. For example:

- (i) A C-factor of 0.15 can be achieved with about 30 percent ground cover where the soils have not been disturbed recently and 50 percent cover where they have been disturbed (as at most construction sites);
- (ii) A C-factor of 0.05 can be achieved with about 55 percent and 70 percent cover on undisturbed and disturbed soils respectively.

“Low” rainfall erosivity is defined as a month with an erosivity of less than 100. The erosivity for a month at a location is calculated by:

$$R\text{-factor} \times \text{percentage of annual EI occurring per month}$$

- (ii) In periods of moderate to high rainfall, achieve a C-factor of less than 0.1 and set in motion a program that should ensure it will drop permanently by vegetation, paving, armouring, etc. to less than 0.05 within a further 60 days.

70. For building works, all landscaping must be installed following with the approved landscape or rehabilitation plan before occupation or use of the premises. All such works must be maintained in a stable and effective condition.

Attachment 1: C-factor

The cover factor, C, is the ratio of soil loss from land under specified plant or mulch conditions to the corresponding loss from cultivated, bare soil. It is different from the runoff coefficient used in the rational method. The most effective method of reducing the C-factor is maintenance, or formation of a good ground cover. The best practices (figure M1, Table M2) are those that reduce both the soil exposed to raindrop impact and the erosive effects of runoff. Additional information is presented in *Managing Urban Stormwater - Soils & Construction*, Landcom (2004).

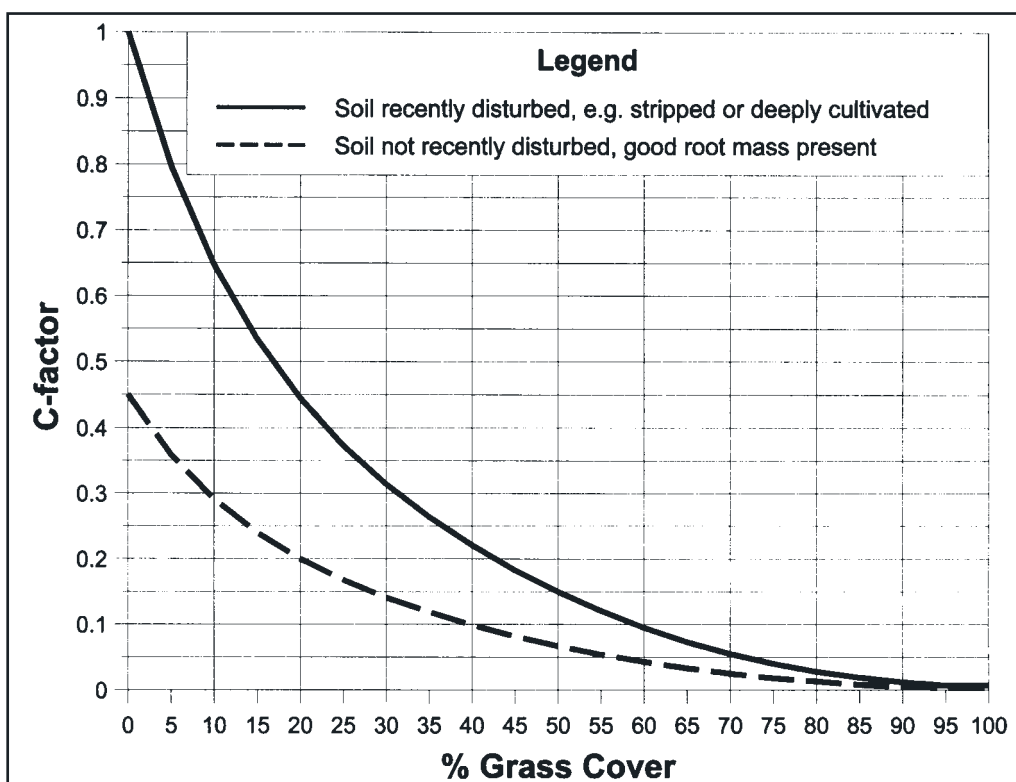


Figure M1 C-factors for established grass cover

Table M2 Soil Stabilization Control Matrix (adapted from various sources, including Meyer and Ports (1976), Israelson *et al.* (1980), Goldman *et al.* (1986), URS Greiner Woodward Clyde (1999) and the North American Green website).

Attachment 2: Environmental Bond

The applicant must lodge a security, deposit or other financial guarantee with [the consent authority] as an assurance that any erosion, sediment and pollution control strategy described in the Plan will be diligently established, implemented and maintained as specified by the approval.

Where the contractor is shown to fail to carry out any part of the approved Plan diligently, a part or all the bond monies might be forfeited and used for carrying out various strategies or rectifying any environmental damage that has occurred as a result. Bond monies will be applied specifically to rectification of problems arising from neglect.

Reimbursement of remaining bond monies will be based on "diligent performance" and "duty of care" indicators separate from any indicators that acceptable levels of erosion, sediment and pollution have been achieved (see Attachment 3). This is to provide incentives for a level of risk management that is sustainable in all conditions of weather and climate, no matter whether such conditions occur during the development covered by the particular Plan.

Attachment 3: Demerit Point System

This demerit system outlines the maximum number of points that can be deducted for any lack of care/diligence in application of a Plan. Funds so collected will be used only for rectification of problems arising from neglect.

A total of 100 points will be allocated for each Plan so that each point represents 1 percent of the total amount held in security. The following is a list of matters that can attract demerit points:

Issues attracting demerit points	Points lost	
	1st offence	2nd offence
failure to regularly complete or keep a Log Book or Inspection Test Plan (ITP)	10	20
failure to secure the site against erosion, sediment and pollution during work site absences satisfactorily	5 points/day for the first two days, thereafter 2 points per day	
failure to implement and maintain erosion, sediment and pollution control devices/structures/procedures satisfactorily at the optimum operating capability specified in the Plan	5	15
disturbance of soil surfaces beyond those specified on the Plan, including parking of work site vehicles in protected areas	5	10
unacceptable amounts of sediment carried to neighbouring road surfaces, gutters and kerbs, including that carried on the wheels of vehicles leaving the site	5	10

Development sites will be routinely checked against the demerit activities to determine any inadequacies in implementing the Plan. The following procedure will be used while carrying out the routine checks:

- (a) If any problems or inadequacies are noted by the responsible government officer, 24 hours notice will be given to rectify them and a \$750 or \$1,500 on-the-spot fine may be issued under the Protection of the Environment Operations Act, 1997, for individuals or corporations respectively;
- (b) If the problems or inadequacies are not rectified within 24 hours, "First Offence" loss of points will apply and/or a \$750 or \$1,500 fine can be imposed under the Protection of the Environment Operations Act, 1997, for individuals or corporations respectively;
- (c) If at a subsequent site inspection, a similar offence occurs then "Second Offence" loss of points will apply and/or a \$750 or \$1,500 fine can be imposed under the Protection of the Environment Operations Act, 1997, for individuals or corporations respectively.

Attachment 4: Responsibilities for Council's Officers

During construction, Council officers will inspect and report on the condition and performance-readiness of any approved Plan strategies for the site. Inspections can occur at the same time as regular or unscheduled building inspections. In consultation with the site manager, officers will:

- check the Log Book and/or Inspection and Test Plan (ITP) for completeness and accuracy
- make notations that help assessment of the current erosion hazard and allow for independent review of this assessment
- record and witness compliance/non compliance with the approved Plan
- record demerit points according to council's directions (Attachment 3) for any deficiencies or breaches of the Plan
- record accumulated demerit points
- make recommendations for averting any immediate or potential erosion, sedimentation or other pollution arising, or likely to arise from the development activities at the site
- draw the attention of the site supervisor to notations, particularly those requiring remedial actions
- report instances of any discharges that are breaches or alleged breaches of the Protection of the Environment Operations Act, 1997
- act to the extent of delegations provided by council to issue breach or infringement notices where pollution discharges are recorded
- stamp, sign and date the Log Book or ITP and initial each notation.

During any inspection, information will be gathered and can be presented to council for possible inclusion in their "State of the Environment" reporting and as an indication of the appropriateness of council's engineering and planning practices.

All council reports on this matter will be made available for an independent audit to achieve the long-term goals established by State and National policies, including among others:

- Council Stormwater Management Plans
- Natural Resource Management Strategy
- National Water Quality Management Strategy
- Ecologically Sustainable Development Guidelines
- Green Cities – Australian Urban and Regional Development Review.

Attachment 5: Issue of Fines

Councils have authority to issue fines under provisions of the Protection of the Environment Operations Act, 1997

The principle matter of consideration when considering if a fine should be issued will be whether the standards embodied in *Managing Urban Stormwater: Soils & Construction*, Landcom (2004) have been adopted. A successful defence against prosecution will rest on an ability to produce evidence of:

- an appropriate *ESCP/SWMP (Plan)* approved by council, and
- diligent application of the measures outlined in the approved Plan, clearly recorded in a Log Book and, where appropriate, an ITP.

Developers should understand that approval of a Plan by council does not reduce the ultimate responsibility for pollution control from owners and managers. Nevertheless, the Plan does provide documentary evidence of the probable level of “diligence and duty of care” that should be exercised in attempting to control erosion of soil and pollution of sediment and, where appropriate, other materials. They should note, too, that multiple fines could be issued for the same offence if warnings are not heeded and/or deadlines are exceeded.

Councils seeking successful prosecutions should establish a process of natural justice that is fair to site owners and managers. Consequently, they have a responsibility to ensure that:

- (i) the approval processes applied to a Plan include scrutiny of its compliance with the standards and guidelines embodied in *Managing Urban Stormwater – Soils & Construction*, Landcom (2004), and
- (ii) the applicant is advised of any concerns council may hold for the Plan not meeting these standards or any other doubts about its likely effectiveness in controlling soil erosion and stormwater pollution.

Councils using the legislation effectively will make entries in the site Log Book/ITP and any council reports that:

- clearly establish that a breach has occurred or is occurring
- establish that clear deadlines for rectification have been set
- provide evidence that the site manager has been properly advised of the deadline
- includes:
 - records of inspections and warnings issued
 - records of unheeded warnings and deadlines.

Further, they will be consistent in their application of procedures.

Class	Type	Suitable for Vegetation Type ^[1]	Design Life (months)	Use in Concentrated Flow ^[2]	Availability (days) ^[3]	Relative Cost Bracket ^[4]	Residual Impact ^[5]	C-factor ^[6] <33%, <6m	C-factor <33%, 6-15m	C-factor <33%, >15m	C-factor 33-50%, <6m	C-factor 33-50%, 6-15m	C-factor 33-50%, >15m	Notes
BIODEGRADABLE MULCHES ^[7]														
Straw (anchored)	4.5 tonnes per hectare	Grass	1 to 6	No	< 5days	Low	Moderate	0.17	0.17	0.20	0.20	0.20	0.20	<p>1 Whether vegetation is required and its type if so, will affect the technique used. Biodegradable mulches, RECPs and hydraulic soil stabilisers can all be used on their own to provide short term protection. However, their effectiveness is less when used in isolation than when used with vegetative growth. Most techniques are used to help establish vegetative growth using sown grasses. Should the client specify shrubs (primarily planted as tubestocks), then thicker mulches, RECPs or biodegradable mulches should be used. Non biodegradable RECP's are used to reinforce grasses (turf) permanently. They are not suitable for use with individual shrubs. They can work synergistically with the established grass to increase its resistance to shear stress and, therefore, increase its resistance to erosion by concentrated flow.</p> <p>2 Products might or might not be suitable for use in areas of concentrated flow. All products are suitable for sheet flow conditions, although some would be over designed in such cases.</p> <p>3 Whether or not a product is readily available is critical to the selection process. Many RECP and hydraulic soil stabiliser techniques use products that might be "off the shelf" and available from several suppliers. Biodegradable mulches can be affected by seasonal variation, although they might also be available on site after initial clearing and grubbing. Temporary seeding might also be seasonal.</p> <p>4 For any given technique, cost can vary greatly depending on geographic location, size of project and installation requirements. In addition, costs can vary over time. Because of these factors, giving accurate installed costs is not possible. However, if a product is relatively inexpensive to purchase and install close to its point of manufacture, it will still be relatively inexpensive to purchase and install remote from it.</p> <p>5 This criterion relates to the impact that a particular practice might have on construction activities once they are resumed on an area that was temporarily stabilised.</p> <p>6 The performance of an erosion control technique is quantified by assigning it with a C-factor (Appendix A). The C-factor will vary from close to zero for full cover, to 1.0 for no cover on highly disturbed soils. The C-factor strongly affects the soil loss calculation (RUSLE) and users need to be careful in specifying its value, particularly when values <0.01 are quoted. Note that the C-factor does not apply to concentrated flow.</p> <p>Values for the C-factor are given for various slopes gradients and lengths and show that it can change dramatically with them. The values given are compiled from existing data and from inference between products of a similar nature. They are given as a guide only and do not profess to be accurate in all respects. Overall, accurate C-factors are only available for manufactured products, primarily from the USA (RECP's in particular) where extensive independent testing has been undertaken. Unfortunately, very little data is available for the "lower cost" options such as biodegradable mulches, jute mesh and hydraulic soil stabilisers. Wherever possible, the manufactures should be contacted for their latest data on acceptable C-factors.</p> <p>For the RECP's in particular, the C-factors given here are for the product as installed with no vegetation. Note however that lower C-factors can be expected if vegetation is promoted with many RECP's. Indeed, non biodegradable RECP's are designed to work synergistically with turf and must be used with it.</p> <p>7 For information on trade names and suppliers of these products, please phone the office of Australasian Chapter of the International Erosion Control Association on 1800 354 322 or (+61 2) 4677 0901.</p>
Wood Chip	16 tonnes per hectare	Grass/Shrubs	1 to 6	No	< 5days	Low	Moderate	0.08	0.08	0.08	No data			
Wood Chip	27 tonnes per hectare	Shrubs	1 to 6	No	< 5days	Low	Moderate	0.05	0.05	0.05	No data			
Wood Chip	56 tonnes per hectare	Shrubs	1 to 6	No	< 5days	Low	Moderate	0.02	0.02	0.02	0.02	0.02	0.02	
Hydromulching	1.5 tonnes mulch + 300 litres binder per hectare	Grass	1 to 3	No	< 5days	Low	Low	0.00	0.03	0.07	0.03	0.06	0.10	
Bonded Fibre	5 tonnes fibre per hectare	Grass	1 to 6	No	< 5days	Low	Moderate	0.00	0.03	0.07	0.03	0.06	0.10	
ROLLED EROSION CONTROL PRODUCTS (RECPs) ^[7]														
Biodegradable	Jute mesh	Grass	6 to 12	Yes	< 5days	Low	Moderate	0.10	0.20	0.40	0.20	0.40	0.60	
	Coconut fibre mesh	Grass	6 to 12	Yes	< 5days	Low	Moderate	0.10	0.20	0.40	0.20	0.40	0.60	
	Curled wood fibre	Grass	6 to 12	Yes	< 5days	Medium	Moderate	0.01	0.05	0.10	0.10	0.15	0.20	
	Jute matting (~350 gsm)	Grass	6 to 12	Yes	< 5days	Medium	Moderate	0.00	0.03	0.07	0.03	0.06	0.10	
	Jute matting (~600 gsm)	Shrubs	6 to 12	Yes	< 5days	Medium	Moderate	0.00	0.03	0.07	0.03	0.06	0.10	
	Coconut fibre matting (~450 gsm)	Grass	6 to 12	Yes	< 5days	Medium	Moderate	0.00	0.03	0.07	0.03	0.06	0.10	
	Coconut fibre matting (~900 gsm)	Shrubs	6 to 12	Yes	< 5days	Medium	Moderate	0.00	0.03	0.07	0.03	0.06	0.10	
Photodegradable	Mesh (< 5 mm openings)	Grass	1 to 6	Yes	< 5days	Low	Moderate	0.01	0.05	0.10	0.10	0.15	0.20	
Non Biodegradable	Plastic fibres with netting	Grass	> 12	Yes	< 5days	High	High	0.00	0.05	0.10	0.03	0.05	0.10	
	Composite with biodegradable	Grass/Shrubs	> 12	Yes	< 5days	High	High	0.00	0.03	0.07	0.03	0.06	0.10	
HYDRAULIC SOIL STABILISERS ^[7]														
	Polymers/Polyacrylamide (rate depends on type)	Grass	1 to 6	No	< 5days	Low	Low	0.01	0.05	0.10	0.10	No data		
	Bitumen emulsion (12,000 l/ha)	Grass	1 to 6	No	< 5days	Low	Low	0.01	0.05	0.10	0.10	No data		
TEMPORARY SEEDING														
	Annual	NA	6 to 12	No	< 5days	Low	Low	0.05	0.05	0.10	0.10	No data		
	Perennial	NA	> 12	No	< 5days	Low	Low to moderate	0.05	0.05	0.10	0.10	No data		
INSTANT TURF ^[7]														
	Kikuyu	Grass	> 12	Yes	< 5days	Medium	Low	<0.01	<0.01	<0.01	<0.01	<0.01	<0.01	
	Reinforced turf (pregrown)	Grass	> 12	Yes	5 - 15 days	High	High	<0.01	<0.01	<0.01	<0.01	<0.01	<0.01	

Table M2



APPENDIX N

N Glossary

Some of this material was drawn from Department of Main Roads (2002), Houghton and Charman (1986) and Morse (1999).

Aggregate – A soil aggregate is a unit of soil structure consisting of primary soil particles held together by cohesive forces or by secondary soil materials such as iron oxides, silica or organic matter. Aggregates can be natural, such as peds, or formed by tillage, such as crumbs and clods.

Alluvial plain – A landform with extremely low relief formed by the accumulation of alluvium from overbank stream flow over a considerable period. This accumulation might still be occurring (floodplain) or might have ceased (c.f. terrace).

Amelioration – Refers to efforts made to minimise adverse effects of an activity (e.g. road construction) after the event.

Apron – A floor or lining at either the inlet or outlet of a hydraulic structure such as a culvert to protect the waterway channel from erosion.

Australian Height Datum (AHD) – A level datum, uniform throughout Australia, based on an origin determined from observations of mean sea level at tide gauge stations, at more than 30 points along the Australian coastline.

Average Recurrence Interval (ARI) – The average or expected value of the period between exceedences of a given rainfall event or discharge.

Backwater – That part of a stream, the water level of which is kept above normal due to some controlling influence downstream.

Barrier – An impediment to surface water placed on or near a contour along the surface to be protected (slopes or channels). Barriers can also be used to divert surface water flow to a stabilised outlet. Various materials can be used depending upon the quantity and depth of water and local availability of materials. Common materials include brush, compacted earth, gravel, hay, rock, sand bags, silt fences and straw bales.

Basin – A hollow or depression within which water can be contained.

Batter – The sideslope of an embankment or cutting.

Batter chute – A temporary or permanent structure designed to convey concentrated storm runoff down a cut or fill embankment or over a change in grade without causing erosion.

Bed and bank – With reference to a watercourse or lake, means land over which the water of that watercourse or lake normally flows or that is normally covered by the water whether permanently or intermittently, but does not include land next to the bed or banks that are periodically covered by floodwaters (c.f. floodplain).

Bench (benching) – (1) A ledge cut or formed in the batter of a cutting or bank, to provide greater security against mass movement; (2) A ledge constructed in a batter or natural slope to segment the slope length to reduce the erosion potential.

Berm – Typically used in reference to slope barrier measures designed to break the continuity of slopes to reduce runoff velocities (c.f. barrier).

Best management practices (BMPs) – “Best management practices” (BMPs) are programs, systems or structures used to mitigate or prevent pollution of receiving waters. The word “best” is a misnomer because the success and effectiveness of a BMP can depend on many variables. Further, the effectiveness of any BMP can vary from day to day, being affected by such factors as climate, time, maintenance, etc.

Biodiversity – The number of species of vegetation and wildlife in a given habitat. Rainforests, which typically have many different plant and animal species, are said to be “high” in biodiversity.

Borrow Pit – An excavation outside the formation limits for obtaining fill.

Broadcast seeding – Any method of planting seed that scatters the seed in random pattern on the surface of the soil.

Buffer zone – Zone next to sensitive areas that are required for protecting streambanks from erosion. They provide habitats along stream corridors and treat overland flow before it enters the drainage network.

Bypass flow – That portion of the flow in a road or in a channel that is not collected by a gully inlet or field inlet and is redirected out of the system or to another inlet in the system.

Capillary water – Water drawn upwards from a free water surface in the ground into soil pores where it is held by surface tension.

Catch drain – A small channel constructed to intercept and divert runoff away from embankments, disturbed areas, and stockpiles.

Catchment area – That area determined by topographical or equivalent features, upon any part of which rain falling will contribute to the discharge of the stream at the point under consideration.

Causeway – A raised carriageway across wet or low areas or across tidal water.

Channel – (1) The bed of a stream or river; (2) A course or passage through which something can move or be directed.

Channel freeboard – Vertical distance between the design water surface elevation in an open channel and the level of the top of the channel bank.

Channel lining – Material placed on the surface of a channel or chute to protect it from erosion. Materials include grass and turf, reinforced grass, erosion control mats, rock lining, rock mattress, cellular confinement and impervious liners.

Channel stabilisation – Materials used to stabilise the channel surface. Examples include soil retention blankets (with appropriate seeding mixture) for nonstructural cover, and concrete or riprap (rock) for structural cover.

Check dam – Check dams are typically used in channels conveying concentrated flows to control flow velocity and minor gully erosion. They can be constructed from semipervious or impervious materials such as medium-size rock or sand and gravel filled bags.

Chute – Used to convey water down slopes and are constructed with materials suited to the expected life of the chute (e.g. concrete).

Clay – A natural earthy material possessing plastic properties and consisting of particles finer than 0.002 mm. Generally, it includes the most chemically active mineral part of a soil. Many of the important physical and chemical properties of a soil depend on the type and quantity of the clay portion. Three broad clay types are recognised, montmorillonite, kaolinite and illite. When used as a soil texture group, such soils contain at least 35 percent clay and less than 40 percent silt (c.f. silt and sand).

Clay loam – A loam with clayey materials predominating.

Clearing – The removal of vegetation, structures or other objects.

Coagulation – Two broad processes can be considered to help reduce suspended solids loads where a significant proportion of these are dispersible fines: coagulation and flocculation. Coagulating agents destabilise colloidal suspensions by neutralising the surface charges allowing settlement; flocculating agents cause the colloidal particles to clump into larger units or “flocs” that can either settle in a reasonable time or be filtered.

Coefficient of runoff – Dimensionless coefficient used in the Rational Method (Pilgrim, 1998) for the calculation of peak runoff discharge.

Coefficient of runoff (volumetric) – The ratio of how much water runs off to the amount that falls in a catchment area.

Cofferdam – A temporary enclosure formed to exclude water from an area in which construction is to take place. Cofferdams can take a variety of forms and are constructed from materials such as driven sheet piling, rock, earth or concrete.

Cohesive soil – A soil whose relevant behaviour characteristics are derived largely or entirely from the cohesive bonds associated with the fine fraction.

Concentrated flow – Water, usually storm runoff, flowing in a confined feature such as a channel, ditch, swale, river, etc.

Consistence – refers to the strength of cohesion and adhesion in soil. Strength is determined by the force just sufficient to break or deform a 20-mm diameter piece of soil when a compressive shearing force is applied between thumb and forefinger:

Loose – No force required

Very weak	–	Very small force, almost nil
Weak	–	Small but significant force
Firm	–	Moderate or firm force
Very firm	–	Strong force but within the power of thumb and forefinger
Strong	–	Beyond power of thumb and forefinger. Crushes underfoot on a hard flat surface with small force
Very strong	–	Crushes underfoot on a hard flat surface with full body weight applied slowly
Rigid	–	Cannot be crushed underfoot by full body weight applied slowly

Controlled activity – is defined in the Water Management Act (2000) (Appendix I) as:

- (a) the erection of a building or the carrying out of a work (within the meaning of the Environmental Planning and Assessment Act, 1979), or
- (b) the removal of material (whether or not extractive material) or vegetation from land, whether by way of excavation or otherwise, or
- (c) the deposition of material (whether or not extractive material) on land, whether by way of landfill operations or otherwise, or
- (d) the carrying out of any other activity that affects the quantity or flow of water in a water source.

Cover crop – Plants, particularly cereals, grown mainly to protect the soil temporarily during or before the establishment of more protective plant cover.

Cover factor – In the Revised Universal Soil Loss Equation (Appendix A), the cover factor, *C*, is the ratio of soil loss from land under specified crop or mulch conditions to the corresponding loss from continuously tilled, bare soil. The *C*-factor is different from the runoff coefficient used in hydrologic calculations. The most effective method of reducing the *C*-factor is maintenance, or formation of a good ground cover such as outlined in Chapter 7.

Crest – The summit or top edge.

Critical depth – The depth occurring in a channel or conduit at a condition of flow such that the specific energy is a minimum for the particular flow.

Cross drainage – A system of pipes or culverts that convey storm flows transversely across or under a roadway.

Crossfall – The slope, at right angles to the alignment, of the surface of any part of a carriageway.

Culvert – One or more adjacent pipes or enclosed channels for conveying a watercourse or stream below formation level.

Dam – A barrier or embankment that confines water.

Detention basin (retention/retarding basin) – A storage pond, basin or tank used to reduce and attenuate the peak discharge within a drainage system. In Australia, detention basins can have an outlet pipe and/or a spillway and the term is interchangeable with retention basin. It is also interchangeable with sedimentation basin when sediment control is the main purpose of the basin.

Dispersible soils – Dispersible soils (Appendix E) are structurally unstable in water and readily split into their constituent fine particles resulting in turbid water that never seems to clear. They can stay in suspension for very long periods, mainly because of negative electrical charges on their surfaces that cause them to repel each other.

Dispersibility relates mainly to particles finer than 0.005 mm diameter (all the clay and the fine silt). Those particles derived from kaolinite clay have relatively few negative charges on their surfaces; those from illite clay have moderate amounts while those from montmorillonite clay have many charges. The only other soil materials likely to carry significant surface charges are colloidal organic matter, some mineral oxides, and silicates of calcium, iron and aluminium.

So, different soils might have different levels of dispersibility depending on their composition and particle size analysis. Those regarded as significantly dispersible are defined as those where more than 10 percent of the soil fraction are affected. That is, where the percentage of clay (materials < 0.002 mm) plus half the silt (roughly those materials between 0.002 and 0.005 mm) multiplied by the dispersion percentage (Ritchie, 1963) is equal to or greater than 10. See Emerson Aggregate Test.

Diversion bank – An earth bank constructed across a slope for intercepting and diverting water. Typically constructed at the upper edges of cut slopes to collect water from nearby properties and divert it around the cut.

Drainage – Natural or artificial means of intercepting and removing surface or subsurface water (usually by gravity).

Drainage catchment – The area of land contributing stormwater runoff to the point under consideration.

Drainage system – A system of gully inlets, pipes, overland flow paths, open channels, culverts and detention basins used to convey runoff to its receiving waters.

Drop-down structure – A hydraulic structure for allowing water to fall to a lower level. It generally includes an energy dissipater (c.f. energy dissipater).

Due diligence – Due diligence is the only real defence to prosecution proceedings for environmental mishaps. It is based on a systematic approach to setting environmental performance standards. Usually, due diligence can be demonstrated only through a three-step environmental management program that ensures:

- the sites' constraints are properly assessed
- BMPs are identified with design criteria that address those constraints
- an adequate safeguard or maintenance program is developed.

Ecologically sustainable development (ESD) – ESD (ESD Steering Committee, 1992) uses, conserves and enhances the community's resources so that ecological processes, on which life depends, are maintained and the total quality of life now and in the future can be increased. It can be broken into four objectives:

- sustainable quality of life
- biodiversity conservation
- pollution minimisation
- resource conservation.

Ecology – The interrelationships between plants, animals and humans that compete and depend on each other for existence in the physical environment.

Electrical conductivity – The electrical conductivities (EC) of 1:5 soil/water suspensions are used to detect the presence of soluble salts and, from this, suggest the general salinity level. The main soluble salts likely to be present are sodium, calcium and magnesium, which might be chlorides, sulfates or carbonates. The standard unit of electrical conductivity in soil is decisiemens per metre (dS/m).

Where the levels of soluble salts rise in soil, they can reduce the vigour or kill existing vegetation increasing the erosion hazards and, in extreme cases, promote the destruction of building works and roads. Rehabilitation of saline soil requires specialised techniques, described above in Chapter 7.

Conventionally, the effect of salinity on plants is described in terms of the electrical conductivity of a saturated extract (EC_e). Multiplier factors are necessary to convert the EC 1:5 values to EC_e values (Hazelton and Murphy, 1992). Note that normal EC meters give results in parts per million (or mg/kg or mg/l). To convert these to decisiemens per metre, divide the results by 640.

EMC – Event Mean Concentration is defined as pollutant load washed off by a storm event divided by the runoff volume.

Emerson Aggregate Test – The Emerson Aggregate Test (EAT) (Emerson, 1967) is an eight-class classification describing the behaviour of air-dried soil aggregates when placed in distilled water. Specifically, it describes whether the aggregates slake or disperse and is recommended as a “backup” test to dispersion percentage.

While both the Emerson and Dispersion Percentage tests show whether soil will disperse, the Emerson test also provides insight to the conditions under which they will disperse. For example, some soil aggregates disperse after being gently placed in water, while others require remoulding or shaking in a 1:5 aggregate water suspension. In the field, soils that require remoulding to disperse are not usually a major problem unless found in positions where they might be pulverised when wet, such as on access roads.

Further, the Emerson tests shows whether soil slake, whereas the Dispersion Percentage test does not. Soils that slake break down in water but do not go into suspension as do

dispersible soil, i.e. the particles settle relatively quickly. Soils that slake are much more erodible than those that do not and require special attention in the erosion control program.

Energy dissipater – Any means to reduce the total energy of flowing water especially high velocity flows. In stormwater design, they are usually mechanisms that reduce velocity before, or at, discharge from an outfall to prevent erosion. Materials used include gabions, concrete splash pads, drop structures, riprap, and boulders.

Environmental Management Plan (EMP) (construction) – Prepared by the construction contractor, considering the management of environmental impacts of activities in a given road project during the construction period. It identifies risks to the environment for the project and the environmental requirements contained within the contract documentation and outlines key strategies for managing these risks and minimising undesirable environmental impacts.

Environmental Management Plan (EMP) (maintenance) – Prepared by the maintenance contractor. It considers the management of environmental impacts of activities in a given maintenance project as well as environmental requirements contained within the contract documentation. It focuses on the minimisation of adverse effects (and the management of these effects) on the environment by maintenance activities required.

Environmental Management Plan (EMP) (planning) – Sets out the overall requirements, outcomes and performance indicators for the design, construction and maintenance of a road project.

Environmental monitoring – Includes activities that gather and evaluate information used for the assessment of environmental performance.

Erosion – (1) The wearing away of the land surface by moving water, wind, ice or other geological agents, including such processes as gravitational creep; (2) Detachment and movement of soil or rock fragments by water, wind, ice or gravity (i.e. accelerated, geological, gully, natural, rill, sheet, splash, or impact, etc.).

Erosion control – Includes the protection of soil from dislocation by water, wind or other agents.

Erosion and Sediment Control Plan – An Erosion and Sediment Control Plan is a component of a Soil and Water Management Plan, but only addresses erosion and sediment control during a construction phase where 250 to 2,500 square metres will be disturbed (Chapter 2). It does not address ongoing or permanent control of pollutants (c.f. Soil and Water Management Plan).

Erosion control practice factor – In the Revised Universal Soil Loss Equation (Appendix A), the erosion control practice factor, P , is the ratio of soil loss with a nominated surface condition ploughed up and down the slope. It is reduced by practices that reduce both the velocity of runoff and the tendency of runoff to flow directly downhill. At construction sites, it reflects the roughening or smoothing of the soil surface by machinery.

Estuary – Under the Water Management Act (2000) (Appendix I), estuary means:

- any part of a river whose level is periodically or intermittently affected by coastal tides, or
- any lake or other partially enclosed body of water that is periodically or intermittently open to the sea, or
- anything declared by the regulations to be an estuary, but does not include anything declared by the regulations not to be an estuary.

Extreme flood – The rare flood event for which the performance of a detention basin or similar structure should be checked to assess the economic and social risk that could be associated with overtopping or failure of that structure.

Filter fabric – See geofabric.

Filter material – Granular material with the grading selected so that it will allow water to pass through it, while retarding the movement of soil particles.

Filter strip – Typically a long, relatively narrow area of undisturbed or planted vegetation used to retard or filter sediment for the protection of watercourses, drainage basins, diversions, reservoirs, or nearby properties.

Flocculant – A chemical agent used to enhance the flocculation process (c.f. flocculation).

Flocculation – Two broad processes can be considered to help reduce suspended solids loads where a significant proportion of these are dispersible fines: coagulation and flocculation. Flocculating agents cause the colloidal particles to clump into larger units or “flocs” that can either settle in a reasonable time or be filtered; coagulating agents destabilise colloidal suspensions by neutralising the surface charges allowing settlement. Flocculation occurs naturally under certain conditions, such as are found in estuaries, saline springs and wetlands; it also occurs in sediment retention basins through human intervention. The most common flocculent used in sediment retention basins in Australia is gypsum, usually applied at a rate of 30 kg per 100 cubic metres of water. It can cause flocculation in most sediment retention basins within 36 to 48 hours.

Flood boundary line – A line defining the edge of the area submerged at the height of a flood. Usually related to a given recurrence interval.

Floodplain – The relatively flat area adjoining the channel of a natural stream that has been or can be inundated with flood waters.

Floodway – Longitudinal depression in a carriageway specially constructed to allow the passage of floodwater across it without damage.

Fraction impervious – That part of a catchment that is impervious, expressed as a decimal or percentage.

Freeboard – The height between a given water level and the underside of a bridge, top of a channel or embankment, or floor of a building to give a factor of safety against calculated design flood levels.

Gabion – A rectangular wire mesh cage filled with rock, brick or similar hard material. The components are usually assembled on site, securely tied together, and used in the construction of retaining walls and anti-erosion structures (c.f. Reno mattress).

Geofabric – (filter fabric, geotextile) – (1) A synthetic fabric, woven or non woven, used for various purposes including:

- embankment reinforcing and stabilization (including in channels)
- seepage control
- pollution containment
- providing a filter layer between dissimilar materials
- as a strain alleviating membrane.

Grading – Any stripping, cutting, filling, stockpiling, or combination of these that modify the land surface.

Grassed swale – Grassed swales are long, shallow, linear water conveyance structures, constructed on soils of significant infiltration capability. Sedimentation can greatly reduce their infiltration capacities and unless they are regularly renovated they become grassed waterways. Their water conveyance capabilities should be protected by selection of suitable non erodible grasses (Table 5.1). Normally, they outlet to the natural drainage system, either directly or indirectly (c.f. waterway).

Ground cover – Any vegetation producing a mat on or just above the soil surface. In forests, this maybe formed by low-growing shrubs, vines, and herbaceous plants under the trees.

Groundwater – The water below the watertable (c.f. watertable).

Grubbing – The removal of roots and stumps below ground level.

Headwater – The height of water above the invert of a culvert measured at the inlet of the culvert.

Hydraulic design – In relation to stormwater drainage, this involves the determination of velocities, the hydraulic grade line and water levels as storm runoff passes through the drainage system.

Hydrograph – A graph of stream height or volume rate of flow past a specific point against time.

Hydrology – Prediction of runoff based on an assessment of rainfall.

Hydromulching – A mechanical method of applying seed, lime, fertiliser and mulch in a water slurry to which has been added soil binders for soil stabilisation (see also soil binder).

Impermeable – Cannot be penetrated by a fluid such as air or water, but commonly refers to water penetration.

Impervious area – The area within a drainage catchment that is impermeable.

Infiltration – The slow movement of water into or through soils or drainage media.

Inlet control – A condition where discharge through a culvert is dictated by the depth of headwater and entrance geometry at the inlet.

Inspection and Test Plan (ITP) – Inspection and Test Plans (ITPs) cover inspection and testing as required by the contract documents for any particular job. They can include the following information:

- the work subject to inspection and test under that plan
- the name of the person completing the plan
- the criteria for acceptance.

The completed ITP should be signed by a properly authorised person to confirm the accuracy of the record.

Intensity-Frequency-Duration Data (IFD) – Rainfall data used in the calculation of the depths and intensities of defined rainfall events.

Invert – The lowest portion of the internal surface of a drain or culvert.

Lake – Under the Water Management Act (2000) (Appendix I), lake includes:

- a wetland, a lagoon, a saltmarsh and any collection of still water, whether perennial or intermittent and whether natural or artificial, and
- any water declared by the regulations to be a lake, whether or not it also forms part of a river or estuary, but does not include any water declared by the regulations not to be a lake.

Land use – The particular use or uses of land within a catchment such as central business, commercial, industrial, residential, open space and parks, major and minor roads.

Leaching – The removal of soluble material and colloids by percolating water.

Legal point of discharge – A point of discharge that is either under the control of a Local Authority or Statutory Authority, or at which discharge rights have been granted by registered easement in favour of the Local Authority or Statutory Authority, and at which discharge from a development will not create a worse situation for downstream property owners than that which existed before the development.

Levee – An earth or rock embankment constructed to prevent flooding of low-lying land or to control the level or direction of flow of a watercourse at a structure.

Level spreader – A device to convert channel or pipe flow to sheet flow to prevent concentrated, erosive flows from occurring and to enhance filtration.

Linear shrinkage – Linear shrinkage relates to the one-dimensional shrinkage of a soil paste moulded at its liquid limit, then oven dried at 105°C for 24 hours. It is expressed as a percentage of the original dimension and indicates the relative shrink-swell potential

of a soil. Problems can occur in interpreting results on dispersible soils (Mills *et al.*, 1980). General information on linear shrinkage is available in Charman and Murphy (2000).

Soil that significantly shrink and swell can cause problems for buildings and roads. They are called expansive or reactive soils. Consequently, linear shrinkage data, when considered with other data relating to particle size analyses, dispersion percentages, Emerson Classes and propensities to shrink or swell, provides valuable background material to the suitability of materials for use in earthworks.

Day-to-day variations in shrinkage and swelling occur because of changes in soil moisture levels. These can be affected by many factors, including rainfall, evaporation demands, tree roots, leaking pipes and groundwater seepages.

Loam – Soil consisting of a mixture of sand, silt and clay, which can contain organic matter.

Major drainage system – The major drainage system is that part of the overall drainage system designed to convey a specified rare flood event. This system can comprise:

- (a) Open space floodway channels, road reserves, pavement expanses and other flow paths that can act as overland flow paths for flows greater than the capacity of the minor drainage system;
- (b) Detention basins and lagoons; and
- (c) Major underground piped systems installed where overland flow is either impractical or unacceptable.

Major road – A road to which is assigned a permanent priority for traffic movement over that of other roads.

Major storm – The design storm with an average recurrence interval selected based on satisfying requirements for flood immunity and safety. Design can vary according local authority guidelines. For most development in New South Wales, the major storm has an average recurrence interval of 1:100 years.

Minor drainage system – The minor drainage system includes kerbs and channels, roadside channels, inlets, underground drainage, junction pits or access chambers and outlets designed to contain and convey a design minor stormwater flow of specified average recurrence interval. This arrangement can also include:

- (a) field gully inlet pits, installed to collect surface runoff from within allotments, as well as the roof water drainage provisions for buildings;
- (b) cross drainage under minor roads where delay or inconvenience during major flows is acceptable. This also includes low flow pipes or box culverts installed under flood ways; and
- (c) low flow pipes installed under drainage reserves or park areas.

Minor road – A road whose primary function is to provide access to individual properties.

Minor storm – The design storm with an average recurrence interval selected by satisfying requirements for convenience and safety of pedestrians and vehicles. Design can vary according to local authority guidelines. For most development in New South Wales, the minor storm has an average recurrence interval of between 1:2 and 1:10 years.

Mulch anchoring – A method used to increase the effectiveness of mulch against surface erosion by water and wind. Binding agents called tackifiers are mixed with the mulch in a water slurry before application.

Mulching – The application of plant residues or other suitable material to the land surface to conserve moisture, holds the soil in place, aids in establishing plant cover, increases infiltration and minimizes temperature fluctuations.

Nodules – Discrete segregations that have accumulated in the soil because of the concentration of some constituent, usually by chemical or biological action.

Non cohesive soil – A soil in which the fine fraction is lacking, resulting in a loss of the cohesive bonds associated with this fraction.

Normal flow conditions – A condition in open channel flow where the depth and velocity of flow achieved is consistent with the prevailing channel shape, slope and roughness.

Obvert – The highest portion of the internal surface of a culvert or arch.

Organic matter – Organic matter is present in soil mostly as:

- roots and root exudates
- incorporated plant residues and materials from their breakdown
- other macro and microorganisms
- respiration products from living organisms.

Organic matter contents are affected by climate, drainage, biological activity, landform and land management practices. It is rapidly depleted by cultivation because of higher oxidation rates (more exposed to air) and by exposing the normally inaccessible organic fraction to decomposition by soil organisms.

In the soil, organic matter is very important, influencing chemical fertility and the physical status, especially structure in medium to coarse-textured materials. It is a key component in determining soil fertility, stability, hydrology and land condition. So, it is more desirable to have higher levels of organic matter than lower levels.

Commonly, the amount of organic matter is derived from the test for organic carbon. To convert percent organic carbon to percent organic matter, multiply the results by 1.755.

Outlet – The point at which water discharges from a stream, river, lake, tidewater or artificial drain.

Outlet control – The situation where factors downstream of the culvert entry such as high water level at the outlet governs the discharge characteristics.

Outlet protection – scour protection placed downstream of a pipe or culvert outlet to complete the transition between pipe flow and open channel flow. Pipe outlet protection can be provided by energy dissipaters, channel protection (nonstructural and structural methods), or a combination of the two (c.f. apron).

Overland flow path – Open space floodway channels, road reserves, pavement expanses and other flow paths that convey flows typically in excess of the capacity of the minor drainage system.

Particle Size Analysis – Particle size analysis (PSA) determines the particle size distribution in a soil. There are various methods commonly used to derive particle size, but the one recommended here (AS 1289 C6.2) involves:

- crushing
- end-to-end shaking with a dispersant (usually Calgon)
- sieving
- sedimentation, measured with a hydrometer.

Size ranges are based on the international scale (Hazelton and Murphy, 1992).

Soil texture is a function of particle size distribution. It influences several aspects related to management of soil and surface waters. For example, the effectiveness of sediment retention structures at any particular site is greatly influenced by the nature of the soil materials at the sediment source. So, data should be presented with any Erosion and Sediment Control Plan showing the proportion of subsoils in the clay and silt sizes (i.e. <0.02 mm) with subsoils (it is the subsoils that are most available for erosion on construction sites). See Soil Texture Group.

Permeability – The property of a material by virtue of which a fluid such as water can pass through it.

Pervious Surface (pervious area) – A surface or area within a drainage catchment where some of the rainfall will infiltrate thus resulting in a reduced volume and rate of runoff, e.g. grassed playing fields, lawns, etc.

pH – Soil pH is a measure of the acidity or alkalinity of a soil. It relates to the concentration of the hydrogen ions (H^+) in the soil solution measured on a negative logarithmic scale of 1 to 14. The concentrations of hydrogen ions are equal to the hydroxyl ions (OH^-) at pH 7, greater below pH 7 (acid) and fewer above (alkaline).

In the urban environment, the importance of pH is usually confined to its effect on the availability of elements in the soil and, therefore, possible deficiencies and/or toxicities. Whether these elements are available to plants depends on their solubilities, being available only when in soluble forms. Note that the “essential” plant nutrients are in their most soluble forms around pH 6 to 7. Even so, plant roots only function above pH 3 and phosphate cannot be absorbed by them above pH 9.

A major problem with acid sulfate soil is that they lower the pH to levels where aluminium becomes soluble (Al^{3+}). While aluminium is one of the most abundant elements found naturally in soil, it is usually found in insoluble forms. The soluble forms are toxic to most plant and animal life.

Piping – See tunnel erosion.

Rainfall erosivity factor – In the Revised Universal Soil Loss Equation (Appendix A), the rainfall erosivity factor, R , is a measure of the ability of rainfall to cause erosion. It is the product of two components: total energy (E) and maximum 30-minute intensity for each storm (I_{30}). So, the total of EI for a year is equal to the R -factor. Rosewell and Turner (1992) have identified a strong correlation between the R -factor and the 2-year ARI, 6-hour storm event. It can be derived from:

$$R = 164.74(1.1177)^S S^{0.6444}$$

where S is the 2-year ARI, 6-hour ARI, rainfall event (mm) (Rosewell and Turner, 1992).

Rainfall intensity – The rate of rainfall in millimetres per hour.

Reno mattress – A mattress-shaped container made of wire mesh, filled with riprap and used to protect earth surfaces from the erosive action of water. It is similar to a gabion, but is used where a gabion would be unnecessarily deep, e.g. lining drop-down structures (c.f. gabion).

Retention basin – See detention basin.

Revetment – A facing of stone or other material lain on a sloping face of earth to maintain the slope in position or to protect it from erosion.

Revised Universal Soil Loss Equation – The Revised Universal Soil Loss Equation (RUSLE) (Appendix A) is designed to predict the long term, average, annual soil loss from sheet and rill flow at nominated sites under specified management conditions. The predicted losses are empirically derived and it is anticipated that the monitoring and comparison of actual soil loss onsite measured against that calculated will lead to a substantiation of the equation. The equation is represented by:

$$A = R K L S P C$$

where, A = computed soil loss (tonnes/ha/yr)

R = rainfall erosivity factor

K = soil erodibility factor

LS = slope length/gradient factor

P = erosion control practice factor

C = ground cover and management factor.

Review of Environmental Factors REF (concept) – Broadly identifies, describes and assesses environmental advantages, disadvantages and constraints associated with a development.

Review of Environmental Factors REF (planning) – Identifies, describes and assesses the environmental advantages, disadvantages and constraints associated with the planning and preliminary design phases of a particular development.

Riprap – Medium to large size rock protection applied (usually by dumping) to the face of an embankment, in a waterway or as an outlet protection from a storage.

River – Under the Water Management Act (2000) (Appendix I), river includes:

- any watercourse, whether perennial or intermittent and whether comprising a natural channel or a natural channel artificially improved, and
- any tributary, branch or other watercourse into or from which a watercourse referred to in paragraph (a) flows, and
- anything declared by the regulations to be a river, whether or not it also forms part of a lake or estuary, but does not include anything declared by the regulations not to be a river.

NOTE: For the purposes of Controlled Activity Approvals (and exemptions to approvals) it is proposed that the “blue line” on topographic maps be used to identify watercourses. Watercourses shown on topographic maps as broken blue lines are deemed continuous if they lose definition and then reappear. Watercourses that were previously blue lines and have now been moved are still deemed to be blue lines in the new location.

Runoff – That portion of the water precipitated onto a catchment area that flows as surface discharge from the catchment area past a specified point.

Runoff coefficient – The coefficient of runoff (Appendix F) is the ratio of how much water is likely to runoff a site against how much rain falls in any particular storm event. It varies from site to site, being affected by many site attributes, especially soil and vegetation types and rainfall intensity. The particular coefficient of runoff selected for a site can greatly affect the design criteria for the various soil and water management structures adopted. Choice can be somewhat subjective and, accordingly, it should always be recorded on the Soil and Water Management Plan or Erosion and Sediment Control Plan.

Run-on – Water that accumulates at a site (compared with runoff water that exits a site).

Sand – Natural mineral particles that are smaller than 2mm, and free of appreciable quantities of clay and silt. Coarse sand usually designates sand grains with particle size between 2 and 0.2 mm, while fine sand usually designates sand grains with particle size between 0.2 and 0.02 mm. Where a particle size analysis includes “very fine sand”, it covers the fraction 0.02 to 0.1 mm, while fine sand covers 0.1 to 0.2 mm. Note that particles finer than about 0.1 mm usually need a hand lens to see them.

Sandy loam – A loam with a proportion of sand or grit sufficient to make the material friable.

Scour – A term commonly used to mean localised erosion of a bank or channel that typically occurs due to excessive slope, turbulence or flow velocity.

Sediment basin – A basin or tank in which stormwater containing settleable solids is retained to remove by gravity or filtration a part of the suspended matter.

Sediment curtain – A piece of material, typically geofabric, attached to floats and weights and extending from the floor of a waterbody (e.g. sea, lake, river) to the surface, and used to trap sediments. Also called silt curtain.

Sediment fence – A barrier typically consisting of permeable material stretched between and attached to supporting posts and entrenched in the earth.

Sediment trap – Generally, sediment traps are smaller versions of sediment basins.

Sedimentation – Deposition of material of varying size, both mineral and organic, away from its site of origin by the action of water, wind, gravity or ice.

Seeding – Refers to the establishment of perennial warm-season grasses for the stabilisation of disturbed soils.

Sheet flow – Water, usually storm runoff, flowing in a thin layer over the ground surface. Also called overland flow.

Silt – An alluvial material intermediate in particle size between sand and clay (0.002-0.02mm). It is usually non plastic.

Slaking – The natural collapse of a soil aggregate in water where its mechanical strength is insufficient to withstand the force of air escaping from within the aggregate.

Slope length-gradient factor – In the Revised Universal Soil Loss Equation (Appendix A), the slope length–gradient factor, LS, describes the combined effect of slope length and slope gradient on soil loss. It is the ratio of soil loss per unit area at any particular site to the corresponding loss from a specific experimental plot of known length and gradient.

Sod – A portable mass of established grass, turf, or groundcover plants.

Sodicity – A measure of the exchangeable sodium percentage (ESP) of soil material. Soil material with an ESP of less than 6 is regarded as non sodic; soil material with an ESP of 6 to 15 is sodic; while soil material with an ESP more than 15 is strongly sodic.

Soil and Water Management Plan – Soil and Water Management Plans describe the measures to be undertaken at development sites that, if carried out, will mitigate soil erosion and control pollution of sediment and nutrients to downslope lands and receiving waters both during and after development. They also include all the information contained in Erosion and Sediment Control Plans.

Soil binder (tackifier) – A biodegradable material used to bind the soil particles together and reduce the erosion hazard for a limited season (one to six months depending in the product and prevailing climatic conditions). Used in hydromulches, but can be used independently (c.f. hydromulching).

Soil erodibility factor (K-factor) – In the Revised Universal Soil Loss Equation (Appendix A), the soil erodibility factor, K, is a measure of the susceptibility of soil particles to detachment and transport by rainfall and runoff. Soil texture is the principle component affecting K, but soil structure, organic matter and profile permeability also contribute. It is a quantitative value experimentally determined.

Soil horizon – A layer of soil, roughly parallel to the land surface, with morphological properties different from layers below and/or above it.

Soil Hydrologic Group – Four Soil Hydrologic Groups (USDA, 1993) discussed are considered here (Appendix F), derived from a consideration of their infiltration and permeability characteristics. These factors, in turn effect on generation of runoff. Vegetation is disregarded because it is usually stockpiled separately on construction sites or, sometimes, removed from construction sites altogether. The four Groups are:

Group A – very low runoff potential. Water moves into and through these soil materials relatively quickly, when thoroughly wetted. Usually, they consist of deep (>1.0 metres), well-drained sandy loams, sands or gravels. They shed runoff only in extreme storm events.

Group B – low to moderate runoff potential. Water moves into and through these soil materials at a moderate rate when thoroughly wetted. Usually, they consist of moderately deep (>0.5 metres), well-drained soils with medium, loamy textures or clay loams with moderate structure. They shed runoff only infrequently.

Group C – moderate to high runoff potential. Water moves into and through these soil materials at slow to moderate rates when thoroughly wetted. Usually, they consist of soils that have:

- moderately fine (clay loam) to fine (clay) texture
- weak to moderate structure and/or
- a layer near the surface that impedes free downward movement of water.

They regularly shed runoff from moderate rainfall events.

Group D – very high runoff potential. Water moves into and through these soils very slowly when thoroughly wetted. Usually, they consist of soils:

- that are fine-textured (clay), poorly structured, surface-sealed or have high shrink/swell properties, and/or
- with a permanent high watertable, and/or
- with a layer near the surface that is nearly impervious.

They shed runoff from most rainfall events.

Soil Texture Group – An important attribute of soils that affects the effectiveness of sediment retention structures is the proportion of particles finer than 0.02 mm. Particles that are finer than 0.02 mm are relatively difficult to trap in simple sediment retention basins, while those that are coarser are not. Therefore, soils are classified into three groups as follows:

-
- *Type D* – 10 percent or more of the soil material is dispersible fines
 - *Type C* – less than 10 percent dispersible fines and 33 percent or less are finer than 0.02 mm
 - *Type F* – less than 10 percent dispersible fines and more than 33 percent are finer than 0.02 mm.

Spillway – An open or closed outlet used to convey water from a reservoir or basin. Usually used to convey a given design runoff.

Stabilisation (soil) – The provision of adequate measures (vegetation, mulches, geofabrics, riprap, and other structural measures) to prevent erosion from occurring.

Stabilised material – A natural material modified to improve or maintain its load carrying capacity or reduce erosion. Modification can be by the addition of other natural materials such as sand, loam or clay or of manufactured materials such as bitumen, lime and cement.

Streambank protection – Measures used to protect existing streambanks from eroding. Measures can include loose or anchored materials such as large boulders, brush mats, geofabrics, logs, or concrete.

Structure – Soil structure refers to the size, shape and arrangement of particles and aggregates, and the size, shape and arrangement of voids or spaces separating the particles and aggregates.

Subcritical flow – Flow in a channel or conduit that has a Froude number less than 1, a depth greater than the critical depth and a velocity less than the critical velocity.

Subsoil drain – A drain below the ground surface, which collects subsurface water throughout its length.

Supercritical flow – Flow in a channel or conduit that has a Froude number less than 1, a depth less than the critical depth and a velocity greater than the critical velocity.

Surface condition – Surface condition refers to the characteristic appearance of the surface soil when dry. Conditions including cracking, firm, loose and soft.

Table drain – The side drain of a road next to the shoulders, having its invert lower than the subgrade level and being part of the formation.

Temporary seeding – Refers to the use of soil stabilisation with grasses that will establish quickly and have longevity of one year or less.

Terrace – A former flood plain on which alluvial deposition and erosion are barely active or inactive.

Terracing – Grading technique that reduces slope length through the creation of benches.

Texture – Soil texture is an estimate of the percentage clay, silt and sand and is determined by the size distribution of mineral particles finer than 2mm.

Time of concentration – The shortest time necessary for all points on a catchment to contribute simultaneously to runoff past a specified point.

Topsoil – The top layers of soil that supports vegetation.

Tunnel erosion – The removal of subsoil by water while the surface remains relatively intact; also called piping.

Unified Soil Classification System – The Unified Soil Classification System (USCS) is an engineering classification based on the particle size distribution and the characteristics of the soil's fine fraction (Casagrande, 1947). It is particularly relevant when applied to those materials used in engineering structures, such as sediment retention basins and other soil conservation structures. The USCS has a major advantage in that soil can be easily classified by experienced persons in the field. However, the system does require an understanding of soil properties that are beyond the scope of this course. For further information on the system, refer to Charman and Murphy (2000).

Vegetative protection – Stabilisation of erodible areas through covering with vegetation.

Watercourse – A river, creek or stream in which water flows permanently or intermittently in a natural or artificial channel.

Watertable – (1) In an aquifer, the upper limit of the portion of ground saturated with water; (2) The natural level at which water stands in a borehole or well under conditions of equilibrium; (3) The upper surface of unconfined groundwater below which the pores of rock or soil are saturated. A perched watertable is the surface of a local zone of saturation held above the main body of groundwater by an impermeable layer, usually clay, and separated from it by an unsaturated zone. Can be permanent or seasonal.

Waterfront land – Under the Water Management Act (2000) (Appendix I), waterfront land means:

- (a) the bed of any river, together with any land lying between the bed of the river and a line drawn parallel to, and the prescribed distance inland of, the highest bank of the river, or
- (a1) the bed of any lake, together with any land lying between the bed of the lake and a line drawn parallel to, and the prescribed distance inland of, the shore of the lake, or
- (a2) the bed of any estuary, together with any land lying between the bed of the estuary and a line drawn parallel to, and the prescribed distance inland of, the mean high water mark of the estuary, and
- (b) if the regulations so provide, the bed of the coastal waters of the State, and any land lying between the shoreline of the coastal waters and a line drawn parallel to, and the prescribed distance inland of, the mean high water mark of the coastal waters, where the prescribed distance is 40 metres or (if the regulations prescribe a lesser distance, either generally or in relation to a particular location or class of locations) that lesser distance.

Land that falls into two or more of the categories referred to in paragraphs (a), (a1) and (a2) can be waterfront land by virtue of any of the paragraphs relevant to that land.

Waterway – Waterways are long, longitudinal water conveyance structures that do not have, as an important part of their design, significant infiltration capacities, although this might occur. Their water conveyance capabilities should be protected by selection of suitable non erodible grasses (Table 5.1). Normally, they outlet to the natural drainage system, either directly or indirectly (c.f. grassed swale).